

Background Material on GST



The Institute of Chartered Accountants of India

(Set up by an Act of Parliament)

New Delhi

© The Institute of Chartered Accountants of India

All rights reserved. No part of this publication may be reproduced, stored in a retrieval system, or transmitted, in any form, or by any means, electronic, mechanical, photocopying, recording, or otherwise without prior permission, in writing, from the publisher.

DISCLAIMER:

The views expressed in this book are of the author(s). The Institute of Chartered Accountants of India may not necessarily subscribe to the views expressed by the author(s).

The information cited in this book has been drawn primarily from the www.cbec.gov.in and other sources. While every effort has been made to keep the information cited in this book error free, the Institute or any office of the same does not take the responsibility for any typographical or clerical error which may have crept in while compiling the information provided in this book.

First Edition	:	July, 2016 (on the basis of June, 2016 MGL)
Second Edition	:	February, 2017 (on the basis of November, 2016 MGL)
Third Edition	:	May, 2017
Fourth Edition	:	August, 2017
Fifth Edition	:	January, 2018
Sixth Edition	:	May, 2018
Seventh Edition	:	March, 2019
Committee/Department	:	GST & Indirect Taxes Committee
E-mail	:	idtc@icai.in
Website	:	www.icai.org ; www.idtc.icai.org
Price	:	₹ 1000/-
ISBN	:	978-81-8441-869-9
Published by	:	The Publication Department on behalf of the Institute of Chartered Accountants of India, ICAI Bhawan, Post Box No. 7100, Indraprastha Marg, New Delhi - 110 002.

Foreword

Goods & Services Tax (GST) has been introduced in India on 1st July, 2017. A new constitutional body named GST Council has been created by the President of India for smooth implementation of GST in our country. GST Council had 33 meetings till date out of which 15 meeting were held post GST implementation. The Central government as well as State governments are committed to resolve the post implementation problems faced by the stakeholders. Central government has estimated a revenue collection of Rs. 11.65 Lacs crore from Indirect Taxes for FY 2019-20 which is 18% more than the estimated pre-GST Indirect Taxes revenue of Rs. 9.85 Crore. It is important to note that such collection is estimated after 30% reduction of rates of taxes on merit goods from 27% to 18%. Simultaneously, GST has not only created a uniform market in India but also provided many benefits to the taxpayers such as availability of cross credit, elimination of cascading effect of taxes, and seamless credit etc.

The Institute has been continuously undertaking various initiatives to support the Government as well as related stakeholders in implementation of GST including submission of suggestions to Government, GSTN and other authorities. Besides this, Institute has been proactively working in creating awareness and disseminating knowledge of GST among various stakeholders.

Keeping pace with the ongoing developments in the GST law, ICAI has now come up with 7th revised edition of its acclaimed publication namely "*Background Material on GST*". This publication contains clause by clause analysis of the GST laws along with the help of Flowcharts, diagrams and MCQ's & FAQ's on GST, etc.

I appreciate the efforts put in by CA. Sushil K. Goyal, Chairman, CA. Rajendra Kumar P, Vice-Chairman, Members of the GST & Indirect Taxes Committee of ICAI and all persons associated with the publication for undertaking this tedious task and revising the material at appropriate time.

I hope the publication would be immensely useful to the members and other stakeholders in their professional endeavors.

CA. Prafulla P. Chhajed
President, ICAI

Date: 11.03.2019

Place: New Delhi

Preface

GST will soon complete its 2nd year in India. Positive impact of GST on the economy is now visible and also burden of tax on the consumer has been reduced significantly. The GST is a game changer for the Indian economy with the increased collection of revenue to Government with each coming month, the level of compliance by the tax payer has also increased significantly, which is evidenced by the increased number of returns being filed.

The ICAI has been proactively supporting the Government by providing its suggestions at each stage of development of GST, be it pre-implementation or Post implementation, be it on policy issues or procedural aspects. Further, we have been playing crucial role in GST Knowledge Dissemination among all the stakeholders through our technical publications, GST Newsletter, Live Webcasts, E-learning, Courses, Conferences, programme and our website. The effort of the Chartered Accountants has also been recognised by the Hon'ble Prime Minister in his letter to the president ICAI on the CA Day in 2018 for making the knowledge dissemination process smoother.

We always stand by the Government with our role as "Partner in Nation Building" and now as "Partner in GST Knowledge Dissemination". With a motive of effective and updated knowledge dissemination, GST & Indirect Taxes Committee is bring this 7th revised edition of its flagship publication "**Background Material on GST**". The efforts has been made to cover all aspects of GST law with details analysis of the provisions in a lucid language. Sections with Rules relevant to the section are also been provided at same place to have better reference of the provisions of the law along with the analysis of the provisions. It also includes the amendment made by GST Amendment Acts, 2018 which became applicable w.e.f. 1st Feb 2019.

We thank CA. Prafulla Premsukh Chhajed, President and CA. Atul Kumar Gupta, Vice-President, ICAI for giving us the space to deliver and support for this progressive law initiative. We would like to acknowledge and thank all our members who supported us to complete the publication. Special thanks to CA S. Venkatramani, CA Jatin Christopher and members of the committee as well as Study Group at Bangalore for sparing their time to thoroughly revising this publication. CA. Daya Shankar Agarwala and members of study Group at Kolkata for reviewing the same. We also appreciate the Secretariat for their unstinted support and delivering unique piece of publication for which so many times they worked beyond the normal working hours. We also welcome suggestions at gst@icai.in.

CA. Rajendra Kumar P.
Vice-Chairman
GST & Indirect Taxes Committee

CA. Sushil Kumar Goyal
Chairman
GST & Indirect Taxes Committee

Date: 11.03.2019

Place: New Delhi

Contents

VOLUME 1

I. THE CENTRAL GOODS AND SERVICES TAX ACT, 2017	1-674
CHAPTER 1: PRELIMINARY	1-68
(Section no. 1 - 2, Rule no. 1 - 2)	
1. Short title, extent and commencement	1
2. Definitions	4
CHAPTER 2: ADMINISTRATION	69-74
(Section no. 3 - 6)	
3. Officers under this Act	69
4. Appointment of officers	71
5. Powers of officers	72
6. Authorisation of officers of State tax or Union territory tax as proper officer in certain circumstances	73
CHAPTER 3: LEVY AND COLLECTION OF TAX	75-177
(Section no. 7 - 10, Rule no. 3 - 7)	
7. Scope of supply	75
8. Tax liability on composite and mixed supplies	114
9. Levy and collection	119
10. Composition levy	139
11. Classification and Exemption	170
CHAPTER 4: TIME OF SUPPLY	178-219
(Section no. 12 - 14)	
12. Time of supply of goods	178
13. Time of supply of services	201
14. Change in rate of tax in respect of supply of goods or services	217
CHAPTER 5: VALUE OF SUPPLY	220-259
(Section no. 15, Rule no. 27 - 35)	
15. Value of taxable supply	220

CHAPTER 6: INPUT TAX CREDIT	260-349
(Section no. 12 - 15, Rule no. 36 - 45)	
16. Eligibility and conditions for taking input tax credit	261
17. Apportionment of credit and blocked credits	277
18. Availability of credit in special circumstances	306
19. Taking input tax credit in respect of inputs and capital goods sent for job-work	324
20. Manner of distribution of credit by Input Service Distributor	330
21. Manner of recovery of credit distributed in excess	347
CHAPTER 7: REGISTRATION	350-405
(Section no. 22 - 30, Rule no. 8 - 26)	
22. Persons liable for registration	351
23. Persons not liable for registration	359
24. Compulsory registration in certain cases	364
25. Procedure for registration	370
26. Deemed registration	384
27. Special provisions relating to casual taxable person and non-resident taxable person	385
28. Amendment of registration	388
29. Cancellation of registration	391
30. Revocation of cancellation of registration	400
CHAPTER 8: TAX INVOICE, CREDIT AND DEBIT NOTES	406-441
(Section no. 31 - 34, Rule no. 46 - 55A)	
31. Tax invoice	406
32. Prohibition of unauthorised collection of tax	433
33. Amount of tax to be indicated in tax invoice and other documents	434
34. Credit and debit notes	434
CHAPTER 9: ACCOUNTS AND RECORDS	442-461
(Section no. 35 - 36, Rule no. 56 - 58)	
35. Accounts and other records	442
36. Period of retention of accounts	458

CHAPTER 10: RETURNS	462-520
(Section no. 37 - 48, Rule no. 59 - 84)	
37. Furnishing details of outward supplies	466
38. Furnishing details of inward supplies	473
39. Furnishing of Returns	478
40. First return	486
41. Claim of input tax credit and provisional acceptance thereof	487
42. Matching, reversal and reclaim of input tax credit	488
43. Matching, reversal and reclaim of reduction in output tax liability	493
44. Annual return	498
45. Final return	501
46. Notice to return defaulters	503
47. Levy of late fee	504
48. Goods and services tax practitioners	506
CHAPTER 11: PAYMENT OF TAX	521-560
(Section no. 49 to 53, Rule no. 85 - 88A)	
49. Payment of tax, interest, penalty and other amounts	521
50. Interest on delayed payment of tax	539
51. Tax deducted at source	544
52. Tax collected at source	553
53. Transfer of input tax credit	559
CHAPTER 12: REFUNDS	561-638
(Section no. 54 - 58, Rule no. 89 - 97A)	
54. Refund of tax	561
55. Refund in certain cases	622
56. Interest on delayed refunds	627
57. Consumer Welfare Fund	630
58. Utilisation of Fund	637

CHAPTER 13: ASSESSMENT	639-663
(Section no. 59 - 64, Rule no. 98 - 100)	
59. Self-assessment	639
60. Provisional assessment	642
61. Scrutiny of Returns	549
62. Assessment of non-filers of returns	654
63. Assessment of unregistered persons	658
64. Summary assessment in certain special cases	661
CHAPTER 14: AUDIT	664-673
(Section no. 65 - 66, Rule no. 101 - 102)	
65. Audit by tax authorities	664
66. Special audit	669
<hr/>	
II. THE INTEGRATED GOODS AND SERVICES TAX ACT, 2017	675-820
<hr/>	
CHAPTER 1: PRELIMINARY	676-693
(Section no. 1 – 2)	
1. Short title, extent and commencement	676
2. Definitions	678
CHAPTER 2: ADMINISTRATION	694-695
(Section no. 3 - 4)	
3. Appointment of officers	694
4. Authorisation of officers of State tax or Union territory tax as proper officer in certain circumstances	694
CHAPTER 3: LEVY AND COLLECTION OF TAX	696-709
(Section no. 5 – 6)	
5. Levy and Collection	696
6. Power to grant exemption from tax	705
CHAPTER 4: DETERMINATION OF NATURE OF SUPPLY	710-727
(Section no. 7 - 9)	
7. Inter-State supply	710
8. Intra-State supply	720

9.	Supplies in territorial waters	724
CHAPTER 5: PLACE OF SUPPLY OF GOODS OR SERVICES OR BOTH (Section no. 10 - 14)		728-784
10.	Place of supply of goods other than supply of goods imported into, or exported from India	728
11.	Place of supply of goods imported into, or exported from India	738
12.	Place of supply of services where location of supplier and <i>recipient</i> is in India	743
13.	Place of supply of services where location of supplier or location of <i>recipient</i> is outside India	768
14.	Special provision for payment of tax by a supplier of online information and database access or retrieval services	778
CHAPTER 6: REFUND OF INTEGRATED TAX TO INTERNATIONAL TOURIST (Section no. 15)		785-786
15.	Refund of integrated tax paid on supply of goods to tourist leaving India	785
CHAPTER 7: ZERO RATED SUPPLY (Section no. 16)		787-802
16.	Zero rated supply	787
CHAPTER 8: APPORTIONMENT OF TAX AND SETTLEMENT OF FUNDS (Section no. 17 - 19)		803-809
17.	Apportionment of tax and settlement of funds	803
18.	Transfer of input tax credit	807
19.	Tax wrongfully collected and paid to Central Government or State Government	809
CHAPTER 9: MISCELLANEOUS (Section no. 20 - 25)		810-819
20.	Application of provisions of Central Goods and Services Tax Act	810
21.	Import of services made on or after the appointed day	814
22.	Power to make rules	815
23.	Power to make regulations	817
24.	Laying of rules, regulations and notifications	817
25.	Removal of difficulties	818

III. THE UNION TERRITORY GOODS AND SERVICES TAX Act, 2017	821-826
CHAPTER 1: PRELIMINARY	822-1228
1. Short title, extent and commencement	822
2. Definitions	823
CHAPTER 2: ADMINISTRATION	827-829
3. Officers under this Act	827
4. Authorisation of officers	827
5. Powers of officers	827
6. Authorisation of officers of Central Tax as proper officer in certain circumstances	827
CHAPTER 3: LEVY AND COLLECTION OF TAX	830-842
7. Levy and Collection	830
8. Power to grant exemption from tax	836
IV. GOODS AND SERVICES TAX (COMPENSATION TO STATES) Act, 2017	843-849
1. Short title, extent and commencement	843
2. Definitions	843
8. Levy and collection of Cess	844
9. Returns, payments and refunds	844
10. Crediting proceeds of Cess to Fund	845
11. Other provisions relating to Cess	846
NOTE ON STATE GST LAWS & RULES	851-852

VOLUME 2

I. THE CENTRAL GOODS AND SERVICES TAX ACT, 2017	853-674
CHAPTER 15: INSPECTION, SEARCH, SEIZURE AND ARREST (Section no. 67 - 72, Rule no. 138 - 141)	853-897
67. Power of inspection, search and seizure	853
68. Inspection of goods in movement (including E-way bill)	864
69. Power to arrest	888
70. Power to summon persons to give evidence and produce documents	891
71. Access to business premises	892
72. Officers to assist proper officers	895
CHAPTER 16: DEMANDS AND RECOVERY (Section no. 73 - 84, Rule no. 142 - 161)	898-954
73. Determination of tax not paid or short paid or erroneously refunded or input tax credit wrongly availed or utilised for any reason other than fraud or any wilful misstatement or suppression of facts	899
74. Determination of tax not paid or short paid or erroneously refunded or input tax credit wrongly availed or utilised by reason of fraud or any wilful misstatement or suppression of facts	905
75. General provisions relating to determination of tax	911
76. Tax collected but not paid to the Government	917
77. Tax wrongfully collected and paid to the Central or a State Government	921
78. Initiation of recovery proceedings	923
79. Recovery of tax	925
80. Payment of tax and other amount in instalments	940
81. Transfer of property to be void in certain cases	944
82. Tax to be first charge on property	946
83. Provisional attachment to protect revenue in certain cases	948
84. Continuation and validation of certain recovery proceedings	951
CHAPTER 17: LIABILITY TO PAY IN CERTAIN CASES (Section no. 85 - 94)	955-986
85. Liability in case of transfer of business	955

86.	Liability of agent and principal	961
87.	Liability in case of amalgamation or merger of companies	963
88.	Liability in case of company in liquidation	969
89.	Liability of directors of Private Company	972
90.	Liability of partners of firm to pay tax	973
91.	Liability of guardians, trustees, etc.	976
92.	Liability of Court of Wards, etc.	977
93.	Special provisions regarding liability to pay tax, interest or penalty in certain cases	979
94.	Liability in other cases	984
CHAPTER 18: ADVANCE RULING		987-1018
(Section no. 95 - 106, Rule no. 103 - 107A)		
95.	Definition clause – interpretation	987
96.	Authority for Advance Ruling	990
97.	Application for Advance Ruling	993
98.	Procedure on receipt of application	997
99.	Appellate Authority for Advance Ruling	1001
100.	Appeal to Appellate Authority	1002
101.	Orders of Appellate Authority	1005
102.	Rectification of advance ruling	1008
103.	Applicability of advance ruling	1010
104.	Advance ruling to be void in certain circumstances	1012
105.	Powers of Authority and Appellate Authority	1014
106.	Procedure of Authority and Appellate Authority	1016
CHAPTER 19: APPEALS AND REVISION		1018-1058
(Section no. 107 - 121, Rule no. 108 - 116)		
107.	Appeals to Appellate Authority	1019
108.	Powers of Revisional Authority	1027
109.	Constitution of Appellate Tribunal and Benches thereof	1029
110.	President and Members of Appellate Tribunal, their qualification, appointment, conditions of service, etc.	1032

111. Procedure before Appellate Tribunal	1036
112. Appeals to Appellate Tribunal	1037
113. Orders of Appellate Tribunal	1043
114. Financial and administrative powers of President	1047
115. Interest on refund of amount paid for admission of appeal	1047
116. Appearance by authorised representative	1048
117. Appeal to High Court	1052
118. Appeal to Supreme Court	1055
119. Sums due to be paid notwithstanding appeal, etc.	1056
120. Appeal not to be filed in certain cases	1057
121. Non-appealable decisions and orders	1058
CHAPTER 20: OFFENCES AND PENALTIES	1059-1099
(Section no. 122 - 138, Rule no. 162)	
122. Penalty for certain offences	1059
123. Penalty for failure to furnish information return	1068
124. Fine for failure to furnish statistics	1070
125. General penalty	1070
126. General disciplines related to penalty	1072
127. Power to impose penalty in certain cases	1076
128. Power to waive penalty or fee or both	1077
129. Detention, seizure and release of goods and conveyances in transit	1078
130. Confiscation of goods or conveyances and levy of penalty	1083
131. Confiscation or penalty not to interfere with other punishments	1086
132. Punishment for certain offences	1087
133. Liability of officers and certain other persons	1090
134. Cognizance of offences	1092
135. Presumption of culpable mental state	1092
136. Relevancy of statements under certain circumstances	1093
137. Offences by companies	1094
138. Compounding of offences	1096

CHAPTER 21: TRANSITIONAL PROVISIONS	1100-1176
(Section no. 139 - 142, Rule no. 117 - 121)	
139. Migration of existing taxpayers	1100
140. Transitional arrangements for input tax credit	1110
141. Transitional provisions relating to job work	1148
142. Miscellaneous transitional provisions	1157
CHAPTER 22: MISCELLANEOUS	1177-1263
(Section no. 143 - 174, Rule no. 122 - 137)	
143. Job work procedure	1178
144. Presumption as to documents in certain cases	1192
145. Admissibility of micro films, facsimile copies of documents and computer printouts as documents and as evidence	1192
146. Common Portal	1195
147. Deemed exports	1196
148. Special procedure for certain processes	1199
149. Goods and services tax compliance rating	1202
150. Obligation to furnish information return	1203
151. Power to collect statistics	1207
152. Bar on disclosure of information	1207
153. Taking assistance from an expert	1209
154. Power to take samples	1209
155. Burden of proof	1210
156. Persons deemed to be public servants	1210
157. Protection of action taken under this Act	1211
158. Disclosure of information by a public servant	1212
159. Publication of information in respect of persons in certain cases	1216
160. Assessment proceedings, etc., not to be invalid on certain grounds	1220
161. Rectification of errors apparent on the face of record	1221
162. Bar on jurisdiction of Civil Courts	1226
163. Levy of fee	1227

164.	Power of Government to make rules	1229
165.	Power to make regulations	1232
166.	Laying of rules, regulations and notifications	1232
167.	Delegation of powers	1233
168.	Power to issue instructions or directions	1235
169.	Service of notice in certain circumstances	1239
170.	Rounding off of tax, etc.	1243
171.	Anti-profiteering measure	1245
172.	Removal of difficulties	1254
173.	Amendment of Act 32 of 1994	1256
174.	Repeal and saving	1256

LIST OF NOTIFICATIONS, CIRCULARS AND ORDERS	1265-1292
--	------------------

Chapter 1

Preliminary

1. Short title, extent and commencement

2. Definitions

Statutory Provision

1. Short title, extent and commencement

- (1) *This Act may be called the Central Goods and Services Tax Act, 2017.*
- (2) *It extends to the whole of India except the State of Jammu and Kashmir.*
- (3) *It shall come into force on such date as the Central Government may, by notification in the Official Gazette, appoint:*

Provided that different dates may be appointed for different provisions of this Act and any reference in any such provision to the commencement of this Act shall be construed as a reference to the coming into force of that provision.

1. *The Central Goods and Services Tax Act, 2017 has been implemented in the State of Jammu and Kashmir from 8th July, 2017 through Constitution (Application to Jammu and Kashmir) Amendment Order, 2017, the Central Goods and Services Tax (Extension to Jammu and Kashmir) Ordinance, 2017 and the Integrated Goods and Services Tax (Extension to Jammu and Kashmir) Ordinance, 2017.*
2. *Certain provisions were came into force on 22.6.17 and remaining provisions on 1.7.17 as notified by the Central Government and hence appointed day for the CGST Act, IGST, UTGST Acts, SGST Acts was 1st July, 2017. However, the appointed day for the State of Jammu and Kashmir was 8th July, 2017.*

Title:

All Acts enacted by the Parliament since the introduction of the Indian Short Titles Act, 1897 carry a long and a short title. The *long title*, set out at the head of a statute, gives a fairly full description of the general purpose of the Act and broadly covers the scope of the Act.

The *short title*, serves simply as an ease of reference and is considered a statutory nickname to obviate the necessity of referring to the Act under its full and descriptive title. Its object is identification, and not description, of the purpose of the Act.

Extent:

Part I of the Constitution of India states: "India, that is Bharat, shall be a Union of States". It provides that territory of India shall comprise the States and the Union Territories specified in the First Schedule of the Constitution of India. The First Schedule provides for twenty-nine (29) States and seven (7) Union Territories.

Part VI of the Constitution of India provides that for every State, there shall be a Legislature, while Part VIII provides that every Union Territory shall be administered by the President through an 'Administrator' appointed by him. However, the Union Territories of Delhi and Puducherry have been provided with Legislatures with powers and functions as required for their administration.

India is a summation of three categories of territories namely – (i) States (29); (ii) Union Territories with Legislature (2); and (iii) Union Territories without Legislature (5).

The State of Jammu and Kashmir enjoys a special status in the Indian Constitution in terms of Article 370 of the Indian Constitution. The Parliament has power to make laws only on Defence, External Affairs and Communication related matters of Jammu and Kashmir. As regards the laws related on any other matter, subsequent ratification by the Government of Jammu and Kashmir is necessary to make it applicable to that State.

Therefore, the State of Jammu & Kashmir were required to pass special laws to be able to implement the Goods and Services Tax Acts. Accordingly, the assembly of J&K passed the GST bill in the first week of July. Subsequently, Honourable President of India had promulgated two ordinances, namely, the CGST (Extension to Jammu and Kashmir) Ordinance, 2017 and the IGST (Extension to Jammu and Kashmir) Ordinance, 2017 making the CGST/ IGST applicable to the State of Jammu and Kashmir, w.e.f. 8th July, 2017. Once the laws are passed by the State of Jammu & Kashmir, the Union Government would have to amend the Central Goods and Services Act, 2017 to delete the phrase that such provisions do not apply to the State of Jammu & Kashmir. After the promulgation of ordinance, the India has adopted GST across the country.

Other Relevant Articles of Constitution

The readers who wish to have a deeper understanding of GST may examine the articles of the Constitution which are relevant to GST. Brief of each is provided hereunder:

Articles 245(2): Law not invalid on ground that it has extra territorial jurisdiction. Important for Place of supply – Section 11,13 of Integrated Goods and service tax act 2017,

Article 246: Sets out that Parliament has exclusive powers to tax activities in List I; State legislature has exclusive powers to tax activities in List II; and both have concurrent powers to activities in List II.

Article 246A(1): Amendment provides notwithstanding Article 246 and subject to article 254(2),Parliament and State legislature have power to impose tax on goods and services. Within the State.

Article 246(2): Further only parliament has powers to tax interstate activities.

Article 249: Parliament has overriding power in GST.

Article 250: Parliament has overriding power in case of emergency

Article 254: Inconsistency in law- Parliament has powers to supersede.

Articles 268: Stamp duties are in Union list- collected by State.

Article 269: Imports deemed to be interstate activity. Interstate taxes collected apportioned as per GST Council recommendation.

Article 269(5): Parliament to have exclusive jurisdiction to determine inter-State character of any supply. Intelligible provisions need to be framed in this regard and not by any delegate but by Parliament itself.

Article 270: Distribution of taxes on stamp duties, consignment sales, surcharge or cess, central GST and IGST used for paying CGST. This is as decided by the Finance Commission.

Article 279: GST Council composition: Chairman- Union Finance minister; Vice Chairman- 1 chosen from among the State; Union Minister of State; and 1 Minister of Finance or other Minister of State for each State.

Article 279A: GST on 5 petroleum products, tobacco and immovable property deferred to date to be specified by GST council.

Article 286: States cannot tax import or export or supply outside the State.

Article 366 (12A): Goods and service tax means any tax on supply of goods or services or both except alcoholic liquor.

Article 366 (26A): Services means anything other than goods.

Relevant Entries in Lists:

Entry 52: List II - Entry Tax (Now Omitted). Some legal experts have a view that States will have inherent powers as the basic structure of the Constitution cannot be changed.

Entry 54: List II - Only 5 petroleum Products and alcoholic liquor for human consumption other than interstate trade.

Entry 55: List II – Advertisement (Omitted)

Entry 62: List II- Entertainment and amusement to local bodies- restricted

Entry 84: List I - Only 5 petroleum products and tobacco products continue.

Commencement:

The CGST Act came into operation on 01.07.2017, the date appointed by the Central Government. However, certain provisions i.e. Sections 1,2,3,4,5,10,22,23,24,25,26,27,28,29, 30, 139, 146,164 were made effective from 22.6.2017 mainly in relation to the provisions of registration and migration.

Statutory Interpretations and Legal Maxims:

The GST Acts like other recent laws in India is not simple and may need to be read considering the general principles of interpretation and may also need to follow legal maxims laid down over centuries. Some principles and legal maxims have been set out below:

- (a) When reading the law the plain language is to be given effect. Meanings contrary to plain language are not permissible.

- (b) Apparent omission in law cannot be made good or rectified by Courts. Necessarily to be amended by making representation. (*Casus Omissus*)
- (c) Purposive interpretation preferable to advance the remedy and not the mischief. (*Heydon's Rule*)
- (d) Notifications issued to further public welfare the law should be reasonable, just, sensible and fair. Normally not to cause hardship, inconvenience, injustice and avoid friction in system.
- (e) Law which is vaguely worded the entire provision can be read as a whole harmoniously.
- (f) The Act prevails over the rule.
- (g) Illustrations cannot modify the law.
- (h) Explanation cannot expand the scope of the provision.
- (i) Terms which are together need to be of same genere (*ejusdem generis*) or gathered by the company they keep (*noscitur a sociis*)
- (j) Multiple non obstante clauses, the last provision would be prevail.
- (k) In case of doubt the later provision prevails.
- (l) Vested rights not to be affected retrospectively.
- (m) Parliament can make law retrospectively to cure defects.
- (n) Levy provisions to favour tax payer if not clear.
- (o) Exemption provisions to favour revenue.
- (p) No presence of guilt needed for penalty unless specified specifically.

The above are some indicative principles. [Detailed article/ video on tdtc@icai.org may be referred for more on legal maxims and constitution]

2. Definitions

In this Act, unless the context otherwise requires-

(1) "actionable claim" shall have the same meaning as assigned to it in section 3 of the Transfer of Property Act, 1882;

One may refer to section 130 of Transfer of Property Act, 1882 regarding the manner of 'transferring' actionable claims. Transfer of actionable claim can be with consideration or without consideration as per the Transfer of Property Act, 1882.

Actionable claim represents beneficial interest in movable property that is not in possession. It is an entitlement to a debt and the holder of the actionable claim enjoys the right to demand "action" against any person. Acknowledgement of liability by a creditor to honor a claim, when made, does not constitute actionable claim in the hands of such creditor.

Examples could be: A claim to any debt other than mortgage- factoring of debtors ; Any beneficial interest in movable property not in ones possession. Readers may get more from the European Unions VAT decision.

The following aspects need to be noted:

- Assignment of actionable claim without permanently supplanting the holder of the claim would not be supply.
- Under the GST regime, actionable claim relating to lottery, betting and gambling alone will be regarded as 'goods' since the definition of goods includes actionable claim.

(2) "address of delivery" means the address of the recipient of goods or services or both indicated on the tax invoice issued by a registered person for delivery of such goods or services or both;

"Address of delivery" is relevant to in the context of determining Place of Supply of goods (other than imports/ exports). Care must be taken to differentiate between 'delivery' and 'location' of the addressee being the recipient.

It is understood that the address of delivery would be a crucial pointer towards the location of goods at the time of delivery to the recipient. The place of supply of goods or services or both (other than imports/ exports) would primarily be the location of the goods or services or both at the time of delivery to the recipient.

(3) "address on record" means the address of the recipient as available in the records of the supplier;

'Address on record' is relevant to determine Place of Supply in case of supplies made by a registered person to an un-registered person in relation to services. In such cases, where the Place of Supply has not been specifically provided for under the law, the address on record available in the records of the supplier would be regarded the Place of Supply.

*(4) "adjudicating authority" means any authority, appointed or authorised to pass any order or decision under this Act, but does not include the –**Central Board of Indirect Taxes and Customs**¹, the Revisional Authority, the Authority for Advance Ruling, the Appellate Authority for Advance Ruling, **the Appellate Authority, the Appellate Tribunal and the Authority referred to in sub-section (2) of section 171**²;*

The following authorities are not permitted to pass an order/ decision under the GST laws:

- (a) The Central Board of Indirect Taxes and Customs
- (b) Revisional Authority
- (c) Authority for Advance Ruling

¹ Substituted vide The Central Goods and Services Tax Amendment Act, 2018 w.e.f 01.02.2019

² Substituted vide The Central Goods and Services Tax Amendment Act, 2018 w.e.f 01.02.2019

- (d) Appellate Authority for Advance Ruling
- (e) Appellate Authority
- (f) Appellate Tribunal

Under the Act, the Revisional Authority, Appellate Authority and the Appellate Tribunal are empowered to pass/ issue order as they think fit, after affording the parties a reasonable opportunity of being heard. However, such powers are limited to cases where an order has been passed by an authority of a lower rank, before it becomes a subject matter of revision/ appeal.

(5) “agent” means a person, including a factor, broker, commission agent, arhatia, del credere agent, an auctioneer or any other mercantile agent, by whatever name called, who carries on the business of supply or receipt of goods or services or both on behalf of another;

This definition appears to illustrate the principle of agency defined in Section 182 of the Indian Contract Act, 1872. Agency is a relationship that can be formed validly even without consideration in terms of Section 185 of the Indian Contract Act, 1872. Agent can work purely on commission basis. Even e-commerce companies like Flipkart, Amazon and Uber may be covered in some fact situations. But the relevance of being an agent is more pronounced while examining whether a transaction between a principal and agent is itself a supply under para 3, schedule I. Very often, the word agent or agency is used without necessarily implying that the transaction is one of agency as understood under Indian Contract Act such as, recruitment agency, travel agency etc. Care must be taken to identify whether the parties intended to constitute an agency as understood in law and nothing less.

(6) “aggregate turnover” means the aggregate value of all taxable supplies (excluding the value of inward supplies on which tax is payable by a person on reverse charge basis), exempt supplies, exports of goods or services or both and inter-State supplies of persons having the same Permanent Account Number, to be computed on all India basis but excludes central tax, State tax, Union territory tax, integrated tax and cess;

The phrase “aggregate turnover” is widely used under the GST laws. Aggregate Turnover is an all-encompassing term covering all the supplies effected by a person having the same PAN. It specifically excludes:

- Inward supplies effected by a person which are liable to tax under reverse charge mechanism; and
- Various taxes under the GST law, Compensation cess.

The different kinds of supplies covered are:

- (a) Taxable supplies;
- (b) Exempt Supplies:
 - supplies that have a ‘NIL’ rate of tax;

- supplies that are wholly exempted from SGST, UTGST, CGST, IGST or Cess; and
 - supplies that are not taxable under the Act (alcoholic liquor for human consumption and articles listed in section 9(2) and in schedule III);
- (c) Export of goods or services or both, including zero-rated supplies. The following aspects among others need to be noted:
- Aggregate turnover is relevant to a person to determine:
 - Threshold limit to opt for composition scheme: Rs. 75 Lakhs in a financial year;
 - Threshold limit to obtain registration under the Act: 20 Lakhs (or 10 Lakhs in case of supplies effected from Special Category States, as explained in our analysis on Section 22) in a financial year.
 - Inter-State supplies between units of a person with the same PAN will also form part of aggregate turnover.
 - For an agent, the supplies made by him on behalf of all his principals would have to be considered while analysing the threshold limits.
 - For a job-worker, the following supplies effected on completion of job work would not be included in his 'aggregate turnover' when working under Section 143:
 - Goods returned to the principal
 - Goods sent to another job worker on the instruction of the principal
 - Goods directly supplied from the job worker's premises (by the principal): It would be included in the 'aggregate turnover' of the principal.

(7) "agriculturist" means an individual or a Hindu Undivided Family who undertakes cultivation of land—

(a) by own labour, or

(b) by the labour of family, or

(c) by servants on wages payable in cash or kind or by hired labour under personal supervision or the personal supervision of any member of the family;

An individual or HUF undertaking cultivation of land, whether own or not, would be regarded as an agriculturist. The cultivation should be undertaken by own labour/ family labour/ servants on wages or hired labour.

It may be noted that the scope of the definition is restricted to an Individual or a Hindu Undivided Family. Any other "person" as defined in section 2(84), carrying on the activity of agriculture will not be considered as an Agriculturist and hence will not be exempted from registration provisions as provided in section 23 (1)(b), of the Act.

Agriculturist providing taxable supplies need to confirm that the aggregate turnover is not exceeded when taking a decision not to register. Everyone who owns agricultural property will not *ipso facto* be eligible for exemption from registration because other taxable supplies may necessitate registration.

(8) "Appellate Authority" means an authority appointed or authorised to hear appeals as referred to in section 107;

It refers to an authority before whom a person aggrieved by a decision/ order under the CGST/ SGST/ UTGST Act may appeal. An order passed by the Appellate Authority would be final and binding on all the parties. If a person is further aggrieved by the order passed by the Appellate Authority, he may prefer an appeal before the Appellate Tribunal or Courts.

(9) "Appellate Tribunal" means the Goods and Services Tax Appellate Tribunal constituted under section 109;

It refers to an authority before whom a person aggrieved by a decision/ order under the CGST/ SGST/ UTGST Act passed by the Appellate Authority/ Revision Authority may appeal. An order passed by the Appellate Tribunal would be final and binding on all the parties. If a person is further aggrieved by the order passed by the Appellate Tribunal, he may prefer an appeal before the High Court.

(10) "appointed day" means the date on which the provisions of this Act shall come into force;

Most of the provisions of the CGST Act are implemented with effect from 1st July 2017 with powers vested to notify different dates for effective date of commencement of different provisions of the Act.

Registration provisions were before appointed date enable easy transition.

(11) "assessment" means determination of tax liability under this Act and includes self-assessment, re-assessment, provisional assessment, summary assessment and best judgment assessment;

The types of assessment covered under the Act are:

- (a) Self-assessment (Section 59)
- (b) Provisional assessment (Section 60)
- (c) Summary assessment (Section 62) including best judgement assessment

The CGST Act also provides for determination of tax liability by:

- (a) Scrutiny of returns filed by registered persons (Section 61)
- (b) Assessment of non-filers of returns (Section 62)
- (c) Assessment of un-registered persons (Section 63)

It may, however, be noted that there is no provision permitting a Proper Officer to re-assess the tax liability of taxable person. As such, reference to such re-assessment in the definition may have to be suitably read down. As per section 59, GST follows self-assessment approach. As such, returns filed will be admitted as assessed. Tax administration is free to scrutinize returns (section 61) or conduct inspection (section 67) and issue notice (section 73-74) but there is no provision for conducting assessment except where taxable person seeks provisional assessment (section 60) in specified circumstances. Authority to pass orders in case of non-filers (section 62) or in case of unregistered persons (section 63) or in certain special cases (section 64) does not dilute the 'self-assessment' approach in GST.

(12) "associated enterprises" shall have the same meaning as assigned to it in section 92A of the Income-tax Act, 1961;

'Associated enterprise' is referred to only in the context of time of supply of services where the supplier is an associated enterprise (located outside India) of the recipient (reverse charge attracted under sec 9(3)).

- In such cases, the time of supply will be the date of entry in the books of account of the recipient of supply or the date of payment, whichever is earlier.
- This in turn means that provisional entries made at the time of closure of books of account for a year (on accrual basis) may trigger GST liability in the hands of the recipient, under section 7(1)(b).

It may be noted that in addition to associated enterprise, the Act also defines 'related person', the reference to which is made in the context of deemed supply (Schedule I) and valuation.

(13) "audit" means the examination of records, returns and other documents maintained or furnished by the registered person under this Act or the rules made thereunder or under any other law for the time being in force to verify the correctness of turnover declared, taxes paid, refund claimed and input tax credit availed, and to assess his compliance with the provisions of this Act or the rules made thereunder;

The definition of 'audit' under the Act is a wide term covering the examination of records, returns and documents maintained/ furnished under this Act or Rules and under any other law in force. Any document, record maintained by a registered person under any law can thus be called upon and audited. It becomes critical for the person to maintain true documents/ records to ensure correctness and smooth conduct of audit.

However it may be important to note that this is neither an investigation nor a revenue leakage exercise and may lead to claim of benefits as well as short payment of taxes being identified.

(14) "authorised bank" shall mean a bank or a branch of a bank authorised by the Government to collect the tax or any other amount payable under this Act;

The date of credit to the account of the Government (i.e., the Central Government in respect of CGST, IGST, UTGST and CESS or the relevant State Government in respect of SGST) in the authorized bank will be considered as the date of deposit in electronic cash ledger.

(15) *“authorised representative” means the representative as referred to in section 116;*

An authorized representative is a person authorized on one’s behalf to appear before an Officer of the Act, Appellate Authority or Appellate Tribunal in connection to proceedings under the Act. Any of the following persons can act as authorized representatives:

- (a) His relative/ regular employee;
- (b) Practicing advocate who is not debarred;
- (c) Practicing Chartered Accountant, Cost Accountant or Company Secretary who is not debarred;
- (d) Retired Officer of the Commercial Tax Department of any State/ Union Territory not below the post of Group-B Gazetted Officer of 2 years’ service;
- (e) GST practitioner

The following persons cannot act as authorized representatives:

- (a) Who is dismissed/ removed from Government service;
- (b) Who is convicted of an offence under any law dealing with imposition of taxes;
- (c) Who is guilty of misconduct by the prescribed authority;
- (d) Who is adjudged as an insolvent.

(16) *“Board” means the Central Board of Excise and Customs constituted under the Central Boards of Revenue Act, 1963*

(17) *“business” includes—*

- (a) *any trade, commerce, manufacture, profession, vocation, adventure, wager or any other similar activity, whether or not it is for a pecuniary benefit;*
- (b) *any activity or transaction in connection with or incidental or ancillary to sub-clause (a);*
- (c) *any activity or transaction sub-clause (a), whether or not there is volume, frequency, continuity or regularity of such transaction;*
- (d) *supply or acquisition of goods including capital goods and services in connection with commencement or closure of business;*
- (e) *provision by a club, association, society, or any such body (for a subscription or any other consideration) of the facilities or benefits to its members;*
- (f) *admission, for a consideration, of persons to any premises;*

- (g) *services supplied by a person as the holder of an office which has been accepted by him in the course or furtherance of his trade, profession or vocation;*
- (h) **activities of a race club including by way of totalizator of a license to book maker or activities of a licensed book maker in such club;** and ³
- (i) *any activity or transaction undertaken by the Central Government, a State Government or any local authority in which they are engaged as public authorities;*

Excise / Service tax laws do not define the term 'business'. However, it is defined under the CST Act / State VAT laws. The definition in the GST law is a modified version of the definition under CST / VAT laws, in as much as the scope is substantially expanded to include among others wager, profession and vocation. This definition is very wide and covers all the transactions that were subjected to various taxes that are being subsumed in the GST Laws.

This definition assumes significance as the proposed levy is on supplies undertaken in the course or furtherance of business. The definition may be understood in two parts, namely:

- (a) **General activity** - trade, commerce, etc., including incidental activities whether or not there is volume, frequency, continuity or regularity of such transactions. Principle of *ejusdem generis* provides that similar activity would be determined by the previous enumerated ones. Please consider that charitable activity would be includible in the definition of business depends on whether the 'source' of income is charitable or 'application' of income is charitable. If business-like sources are used to raise funds, such institutions may be liable to GST although these funds are not distributed to promoters but expended for purposes of the beneficiaries.
- (b) **Specific activity** – acquisition of goods including capital goods, supply by association/ club, admission of persons to a premises and services by a race club.

The following aspects need to be noted:

- 'Wager' is also included in the definition of business to impose GST on betting transactions;
- Educational services would be covered under profession or business however the sale of uniforms, mess facilities could be covered;
- Charitable or religious activities are not specifically covered however fund raising activities like letting out of hoardings, sale of books could be considered as business;
- Clause (e) may pose some difficulty as associations and its members enjoy immunity from taxation on transactions amongst themselves by the 'principle of mutuality'. However, this expression inclusion in the definition appears to override the said principle for the limited purposes of GST. In other words, contribution by members to their association is not taxable under Income-tax Act (where the said principle prevails) but will be taxable under GST;

³ Substituted vide The Central Goods and Services Tax Amendment Act, 2018 w.e.f. 01.02.2019

- Clause (g) may require understanding of employment as differentiated from profession. For instance, if a CA in practice provides services as Independent Director, the service provided by him may be treated as 'business' and not 'employment'.
- Clause (i) is also very important as 'any' activity or transaction by Government is included in the definition of business this will have far-reaching implications as the responsibility to pay tax in respect of services by Government is covered under reverse charge mechanism. Due to the expansive words used here, there is no room to differentiate payments made to any Government department on the ground that it is not 'business' activity.

~~(18) "business vertical" means a distinguishable component of an enterprise that is engaged in the supply of individual goods or services or a group of related goods or services which is subject to risks and returns that are different from those of the other business verticals.~~

~~Explanation For the purposes of this clause, factors that should be considered in determining whether goods or services are related include—~~

- ~~(a) the nature of the goods or services;~~
- ~~(b) the nature of the production processes;~~
- ~~(c) the type or class of customers for the goods or services;~~
- ~~(d) the methods used to distribute the goods or supply of services; and~~
- ~~(e) the nature of regulatory environment (wherever applicable), including banking, insurance, or public utilities;⁴~~

~~A person having multiple business verticals in a State/ Union Territory is permitted to obtain separate registrations for each such business vertical. Therefore, the person will have an option to avail a single registration (covering all business verticals in a State or Union Territory) or separate registration for each business vertical in a State or Union Territory.~~

~~The following aspects need to be noted:~~

- ~~The component must be a **distinguishable component** of the person, which is capable of being transferred or to function without affecting any other business of that person. A component cannot become a 'business vertical' merely based on geographical differentiation;~~
- ~~The supplies made by one business vertical unit should be:

 - ~~(a) individual goods or services or a group of related goods or services; and~~
 - ~~(b) subject to risks and returns different from those of the other business verticals;~~~~
- ~~The risk and returns of supplies forming part of a business vertical should be same;~~

⁴ Omitted vide The Central Goods and Services Tax Amendment Act, 2018 w.e.f 01.02.2019

- ~~Interestingly, graphical separation by itself cannot be a criterion to segregate the business into distinct business verticals;~~
- ~~Supplies between business verticals are deemed to be taxable supplies;~~
- ~~Lastly, the option to avail composition scheme is PAN based and hence, a person has to opt for composition scheme for all the business verticals across India. He cannot opt for the scheme only in a particular business vertical;~~

Note: This concept has been diluted now with any number of registration available within a State. The need for it to be a business vertical has been done away with. by the Central Goods and Service Tax (Amendment) Act, 2018, with effect from 1 February, 2019.

(19) "capital goods" means goods, the value of which is capitalised in the books of account of the person claiming the input tax credit and which are used or intended to be used in the course or furtherance of business;

An attempt has been made to align the meaning of capital goods to the generally accepted standards of accounting of what is considered as revenue and what as capital

Goods will be regarded as capital goods if the following conditions are satisfied:

- (a) The value of such goods is capitalised in the books of account of the person claiming input tax credit;
- (b) Such goods are used or intended to be used in the course or furtherance of business.

The following aspects need to be noted:

- (a) Assuming that the value of capital goods was not capitalised in the books of account, the person purchasing the capital goods would still be eligible to claim input tax credit on such capital goods since the definition of 'input tax' applies to goods as a whole (including capital goods).
- (b) Capital goods lying at the job-workers premises would also be considered as 'capital goods' in the hands of the purchaser as long as the said capital goods are capitalized in his books of account.

Capitalized value of capital goods may include services as an incidental component of a composite supply. Expression 'capital goods' is the identity of what is capitalized although it may come into existence along with services. There is no basis to carve out service value embedded in the capitalized value if they are capital goods. In case of turnkey works contract (necessarily an immovable property) it would be deemed to be a service. Please note that CWIP may involve credits which are available immediately on their receipt (of the goods and their invoice). Therefore, one may not have to defer availment of credit until actual capitalization in the books in view of the time restriction for availment of credit being reckoned from 'date of invoice'. GST law does not introduce these fine distinctions between 'yet to be' capitalized goods and 'already' capitalized goods. Any delay in capitalization can prove costly

due to the time limit for availment of credit. This maybe true for long term contracts of setting up plants. Further, the expression 'capital goods' gives rise to some questions about 'capitalized services'. Here it may help to note that 'input services' is not restricted to services that are revenue in nature. Capitalized services do not fail to satisfy the definition of input services. Care must be taken while claiming credit in respect of capitalized services in case of use commonly for making taxable and exempt outward supplies.

(20) "casual taxable person" means a person who occasionally undertakes transactions involving supply of goods or services or both in the course or furtherance of business, whether as principal, agent or in any other capacity, in a State or a Union territory where he has no fixed place of business;

A person would be regarded as a casual taxable person if he undertakes supply of goods or services or both:

- (a) Occasionally, and not on a regular basis;
- (b) In the course or furtherance of a 'business' that exists;
- (c) Either as principal or agent or in any other capacity;
- (d) In a State/ Union Territory where he has no fixed place of business.

A trader, businessman, service provider, etc. in one State undertaking occasional transactions like supplies made in trade fairs in another State would be treated as a 'casual taxable person' in that other State and will have to obtain registration in that capacity and pay tax. E.g., A jeweller carrying on a business in Mumbai, who conducts an exhibition-cum-sale in Delhi where he has no fixed place of business, would be treated as a 'casual taxable person' in Delhi. Question that comes up for consideration is whether a person who does not undertake business activity (assume this test is satisfied), would such a person be a CTP in home-State when business-like transactions are occasionally undertaken? This is not an easy question but proceeding on the basis that 'business' test is conducted and found that activity is not a business, then there is no question of registration and compliance as CTP. The next question is, in case business transactions are regularly undertaken but below threshold limit, would such a person be a CTP and if so, in the home-State or another State or both? The answer would be that due to threshold benefit, person would not be TP or CTP in home-State. And due to business activities in another State, CTP would be triggered in the other State subject due to fiction under section 24 leading to requirement of registration being attracted in home-State due to inter-State supplies. This leads us to a view that in order to be CTP in any State, person must already be in business in home-State, even if within threshold limit for registration, which may go away due to inter-State supplies being involved between the two branches.

The following aspects need to be noted:

- The threshold limits for registration would not apply and he would be required to obtain registration irrespective of his turnover;

- He is required to apply for registration at least 5 days prior to commencement of business;
- The registration would be valid for 90 days or such period as specified in the application, whichever is shorter;
- An advance deposit of the estimated tax liability is required to be made along with the application for registration. Although the wordings are 'estimated tax liability', it is clarified vide 71/45/2018-GST dated 26 October, 2018 that deposit must be made of estimated 'net' tax liability after reducing estimate of available input tax credit.

(21) "Central tax" means the central goods and services tax levied under section 9;

Tax levied under this Act is referred to as "Central tax" as opposed to "CGST" as used in the model GST laws. It refers to the tax charged under this Act on intra-State supply of goods or services or both (other than supply of alcoholic liquor for human consumption). The rate of tax is capped at 20% and thereafter, the rates for goods and services will be notified by the Central Government based on the recommendation of the Council.

(22) "cess" shall have the same meaning as assigned to it in the Goods and Services Tax (Compensation to States) Act;

It refers to the 'cess' levied on certain supplies (inter-State or intra-State) as notified, for the purposes of providing compensation to the States for loss of revenue arising on account of implementation of GST, for a period of five years (or extended period, as may be prescribed).

(23) "chartered accountant" means a chartered accountant as defined in clause (b) of sub-section (1) of section 2 of the Chartered Accountants Act, 1949;

(24) "Commissioner" means the Commissioner of central tax and includes the Principal Commissioner of central tax appointed under section 3 and the Commissioner of integrated tax appointed under the Integrated Goods and Services Tax Act;

(25) "Commissioner in the Board" means the Commissioner referred to in section 168;

It refers to the Commissioner or Joint Secretary posted in the Central Board of Excise and Customs. Such a Commissioner or Joint Secretary is empowered to exercise the function of the Commissioner with the approval of the Board.

(26) "common portal" means the common goods and services tax electronic portal referred to in section 146;

The Common Goods and Service Tax Electronic Portal ("GST portal") is a common electronic portal set up by the Goods and Service Tax Network (GSTN) that facilitates among others registration, payment of tax, filing of returns, computation and settlement of IGST, electronic way-bill and other functions under the Act.

(27) "common working days" in respect of a State or Union territory shall mean such days in succession which are not declared as gazetted holidays by the Central Government or the concerned State or Union territory Government;

Common working days refer to such days *in succession* which are not a declared holiday for the Centre as well as State/ Union Territory.

The relevance of working days primarily arises in relation to registration provisions. Every person obtaining a registration under the Act is required to make an online application in the GST portal. The application for registration, along with the accompanying documents will be examined by the Proper Officer and if found in order, the registration will be granted within 3 working days. If the proper officer fails to take any action within 3 working days, the application is deemed approved.

Since the reference to 'common workings days' has been replaced by 'working days', it remains to be seen whether the applicant will be granted a deemed registration after 3 working days in case of inaction by the Proper Officer even if the third day was a holiday for a State.

(28) "company secretary" means a company secretary as defined in clause (c) of sub-section (1) of section 2 of the Company Secretaries Act, 1980;

(29) "competent authority" means such authority as may be notified by the Government;

In terms of Explanation to entry 5(b) of the Schedule II to the Act, "Competent Authority" in relation to construction of a complex, building, civil structure covers:

- (a) Authority authorised to issue completion certificate (local municipal authorities like BDA/ BBMP in Bangalore, PMC in Pune)
- (b) Architect
- (c) Chartered Engineer
- (d) Licensed Surveyor

(30) "composite supply" means a supply made by a taxable person to a recipient consisting of two or more taxable supplies of goods or services or both, or any combination thereof, which are naturally bundled and supplied in conjunction with each other in the ordinary course of business, one of which is a principal supply;

Illustration– Where goods are packed and transported with insurance, the supply of goods, packing materials, transport and insurance is a composite supply and supply of goods is a principal supply.

A supply will be regarded as a 'composite supply' if the following elements are present:

- (a) The supply should consist of two or more taxable supplies.;
- (b) The supplies may be of goods or services or both;
- (c) The supplies should be naturally bundled.;
- (d) They should be supplied in conjunction (event, time or contract) with each other in the ordinary course of business.;
- (e) One of the supplies being a principal supply (Principal supply means the predominant

supply of goods or services of a composite supply and to which any other supply is ancillary).

The following aspects need to be noted:

- Please consider that reference to two or more 'taxable supplies' found in the definition appears as two or not 'supplies' in section 8(a). As section 8 guides the determination of tax liability based on that supply which enjoys the higher rate of tax, the definition must be read to main harmony with section 8.
- The way the supplies are bundled must be examined. Determining natural bundling must be done with caution such that two supplies occurring simultaneously ought not to be presented as naturally bundled. And any artificial bundling must be sought out with equal care as they could fall within mixed supply and not composite supply.
- Mere conjoint supply of two or more goods or services does not constitute composite supply. Habitually supplied together by one firm in the industry may not be adequate to make the two supplies conjoint. Test is less about what one (or few) firms do but what is accepted in trade / expected by customers to be presently conjointly
- The two (or more) supplies must appear natural when bundled and presented to the recipient.
- The ancillary supply becomes necessary only because of the acceptance of the predominant supply. Such predominance is neither guided by the predominant component in the total price of the supply nor guided by the predominant material involved. The test of predominance must be gathered from the 'predominant object' for which the recipient approached the supplier;
- The method of billing, assignment of separate prices etc. may not be relevant. In other words, whether separate prices are charged for each of the components of supply or a single consolidated price charged, the identity of each of the components of supply must be unmistakably distinct in the arrangement;
- The tax treatment of a composite supply would be as applicable to the principal supply.

Illustrations of composite supply are as follows:

- (a) Accommodation with breakfast;
- (b) Cocktail drink being a mixture of alcohol with a non-alcoholic pre-mixed;
- (c) Supply of laptop and carry case of same company;
- (d) Supply of equipment and installation of the same;
- (e) Supply of repair services on computer along with requisite parts- Comprehensive AMC;
- (f) Supply of health care services along with medicaments.

It may be noted that Buffet with alcohol for a couple on new year eve for a single price would not be composite supply as only taxable supplies are covered.;

Not all supplies which are given together are composite supply merely because there are more than one taxable supplies simultaneously supplied. Unrelated, unconnected and independent taxable supplies that are supplied simultaneously for individual prices where each of them are intended to be the predominant object for which the recipient approached the supplier and may, to contrast with composite supply, be referred as non-composite supply. This is other than the mixed supply examined further.

(31) “consideration” in relation to the supply of goods or services or both includes—

(a) any payment made or to be made, whether in money or otherwise, in respect of, in response to, or for the inducement of, the supply of goods or services or both, whether by the recipient or by any other person but shall not include any subsidy given by the Central Government or a State Government;

(b) the monetary value of any act or forbearance, in respect of, in response to, or for the inducement of, the supply of goods or services or both, whether by the recipient or by any other person but shall not include any subsidy given by the Central Government or a State Government:

Provided that a deposit given in respect of the supply of goods or services or both shall not be considered as payment made for such supply unless the supplier applies such deposit as consideration for the said supply;

The following aspects need to be noted:

- It refers to the payment received by the supplier in relation to the supply, whether from the recipient or any other person. Therefore, a third party to a contract can also contribute towards consideration;
- Consideration, therefore, is not the amount that the recipient pays but the amount that the supplier collects whether from the recipient or any third party. This would be particularly relevant in dealing with complex arrangements in digital economy and new-age business. It is permissible that ‘stranger’ (to the contract) may contribute towards consideration;
- Consideration can be in the form of **money or otherwise**. ‘Otherwise’ may refer to consideration that is not ‘money’ as defined in section 2(75). E.g.: Under a JDA model, the flats handed by the developer to the landowner would be considered as ‘consideration’ for the development rights given to the developer by the landowner;
- Clause (b) appears to cast the net so wide as to leave nothing to escape its grasp, almost nothing Reference may be had to the discussion under section 15 on valuation for the far-reaching implications of the expansive language used in this clause. Sufficient to state here that every act or abstinence that is a motivation to induce a person is already consideration and there is no requirement for it to be in monetary form. The hindi expression for consideration is “Pratiphal” and inspiring in meaning.
- Unmotivated unilateral actions or gratuitous acts would not be consideration. Transactions that involve negative consideration or abstinence from doing anything are all examples of consideration due to the language in this clause. Consideration can

therefore be – increase in cash or other assets, increase in debt or other liabilities or abstinence/ tolerance of any act;

- Deposits, as such, are not liable to tax. However, where such deposits have been applied as consideration for the supply it would tantamount to making of advances and in such cases, will be liable to tax. Merely altering the nomenclature of the payment as 'deposit' would not change the nature of the receipt. However, trade practices and the terms, used play an important role in identifying whether an amount is a 'deposit' or an 'advance' or any payment as consideration for the supply;
- Deposits would be considered to be considered when the "supplier applies the deposit 'as' consideration". Had the proviso used the words "supplier applies the deposit 'towards' consideration", the meaning may have been limited to cases where consideration due is appropriated out of the amount held in deposit. But the usage of 'as' seems to enjoy intrinsic value in the 'eyes' of supplier in accepting the deposit. Comparative examination of transactions with / without deposit could throw some light on the 'effect' that the deposit has in the 'eyes' of supplier;
- The suppliers may have to place the deposits in a separate bank account in case of refundable deposits, to comply with this provision. However, whether the amount is refundable or not is not a criterion to determine whether such amount is a 'deposit';
- This is an inclusive definition.

(32) "continuous supply of goods" means a supply of goods which is provided, or agreed to be provided, continuously or on recurrent basis, under a contract, whether or not by means of a wire, cable, pipeline or other conduit, and for which the supplier invoices the recipient on a regular or periodic basis and includes supply of such goods as the Government may, subject to such conditions, as it may, by notification, specify;

In the definition "provided" may be read as supplied.

It refers to supply of goods continuously or on recurrent basis under a contract, with periodic payment obligations.

The following aspects need to be noted:

- It should be a contract for supply on a recurrent basis and cannot be a one-time supply contract. Mere case of regular or repeated supply with deferment of billing will not make it a continuous supply. Something more is required for the supply to be 'continuously or on recurrent basis' that renders time of supply indeterminate. Eg. supply of water cans every day for use in office, but billing specified to be fortnightly may not be a case of continuous supply as there is nothing more to be done after delivering water cans except to issue invoice. Once the water cans are supplied for the day, there is no justification to delay the billing by fifteen days unless there is something more that is required to be done, either by supplier or by recipient, to establish its completion. In such cases, the terms of contract are permitted to guide the determination of time of supply;

- The contract should be a case of periodic billing and periodic payments - viz., the billing and receipts thereto should be on a periodic basis (e.g.: every fortnight; every Monday etc.) and not one-time. Further, the contract should specify this periodicity/ frequency of billing/ payment;
- The mode of supply would not be relevant - viz., such supply may be through a wire, cable, pipeline or other conduit or any other mode;
- The Government is empowered to notify certain supplies as continuous supply of goods.

Examples of continuous supply of goods are:

- (a) Open purchase orders with daily delivery schedule (Just In Time- JIT) subject to acceptance tests only at the time of issue-for-production and understanding of fortnightly billing;
- (b) VMI (vendor managed inventory) where the agreed periodicity for billing is, say, monthly/ fortnightly etc.;
- (c) Supply of gases through pipeline where burn rate or heat generation are matters of contingency necessitating a deferred billing schedule.

(33) "continuous supply of services" means a supply of services which is provided, or agreed to be provided, continuously or on recurrent basis, under a contract, for a period exceeding three months with periodic payment obligations and includes supply of such services as the Government may, subject to such conditions, as it may, by notification, specify;

It refers to supply of services continuously or on recurrent basis under a contract for a period exceeding 3 months, with periodic payment obligations.

The determination of stage of completion of services is an abstract one, unless specifically defined by contract, unlike in the case of goods where the volume of goods supplied can be easily tracked/ identified. Hence, a contract for supply of service spanning over a definite period has been treated as a continuous supply, so that the tax dues are collected periodically.

The law categorically provides for time limit to issue invoices as under:

- (a) where due date of payment is ascertainable: On or before the due date of payment;
- (b) where the due date of payment is not ascertainable: Before or at the time of receipt of payment;
- (c) where the payment is linked to the completion of an event (milestones): On or before the date of completion of that event.

The following aspects need to be noted:

- It should be a contract for supply on a recurrent basis and cannot be a one-time supply contract. Similar to goods, supply of services where there exists some facts that render

time of supply indeterminate. For eg. Construction services where work completion is subject to remeasurement and certification by Architect and hence time of supply on actual events like pouring concrete or laying tiles is not sufficient to establish completion of supply ;

- The period of contract of supply should be more than 3 months - viz., services should be supplied on a recurring basis for at least 3 months;
- The contract should be a case of periodic billing and periodic payments - viz., the billing and receipts thereto should be on a periodic basis (say for e.g.: every fortnight; every Monday etc.) and not one-time. Further, the contract should specify this periodicity/frequency of billing/ payment;
- The Government is empowered to notify certain supplies as continuous supply of goods.

Examples of continuous supply of services:

- (a) Annual maintenance contracts because it comprises of supply of assurance of regular upkeep, supply of parts for repairs and supply of labour for such repairs. However, where invoice is issued at the start of this contract period, time of supply get determined based on the billing and does not get deferred based on the mile-stones in the contract;
- (b) Licensing of software or brand names;
- (c) Renting of immovable property except month-to-month lease/rent; and
- (d) Software as a service (SAAS) with monthly billing based on usage.

Annual asset insurance contract will NOT be a case of continuous supply of services as the sole supply here is 'assurance' which is supplied at the start of this contract. Payment of compensation in the event of any claim-incident would not be another supply (actually not possible as insurance company pays compensation and does not collect compensation) but merely a continuing obligation attendant to the original supply of assurance.

It may be noted that at times the accounting standard on revenue recognition may be a variance with the time of supply.

(34) "conveyance" includes a vessel, an aircraft and a vehicle;

It can be understood as a medium of transportation.

(35) "cost accountant" means a cost accountant as defined in ~~clause (c)~~ clause (b)⁵ of sub-section (1) of section 2 of the Cost and Works Accountants Act, 1959;

(36) "Council" means the Goods and Services Tax Council established under article 279A of the Constitution;

⁵ Substituted vide The Central Goods and Services Amendment Act, 2018 w.e.f. 01.02.2019

GST Council is an authority constituted under the Constitution of India and will be the governing body responsible for the administration of the GST across India. The administrative powers will be vested with this authority for taxing goods and services.

The Council will consist of the Union Finance Minister (as Chairman), the Union Minister of State in charge of Revenue or Finance, and the Minister in charge of Finance or Taxation, or any other nominated by each State government, thereby ensuring a proper blend of the Central and State ministry.

The GST Council will be the body responsible for the following (primarily):

- (a) Administration of the GST laws
- (b) Specify the taxes to be levied and collected by the Centre, States and Union Territories under the GST regime
- (c) Specify the goods or services or both that will be subjected/ exempted under the GST regime
- (d) Specify the GST rates
- (e) Specify the threshold limits for registrations and payment of taxes
- (f) Apportionment of IGST between Centre and States/ Union Territories
- (g) Approval of compensation to be paid to the States (for loss on account of implementation of GST)
- (h) Levy of any special rate or rates of tax for a specified period, to raise additional resources during any natural calamity or disaster.
- (i) Resolution of disputes arising out of its recommendations
- (j) Imposition of additional taxes in times of calamities and disasters

(37) "credit note" means a document issued by a registered person under sub-section (1) of section 34;

A credit note can be issued by a supplier only in the following circumstances:

- (a) The taxable value shown in the invoice exceeds the taxable value of the supply;
- (b) The tax charged in the invoice exceeds the tax payable on the supply;
- (c) The goods supplied are returned by the recipient;
- (d) The goods/ services are found to be deficient.

The following aspects need to be noted:

- Where there is no change in the taxable value/ tax amount, a credit note must not be issued unlike normal existing business practices;
- A credit note has to be issued by the supplier only and no other person is permitted;
- A credit note issued by a recipient, say for accounting purposes, is not a relevant

document for GST purposes; In business at times the supplier may only issue a financial credit note i.e. only for the basic value without including the GST component. Such financial credit notes are recognized in circular 72/46/2018-GST dated 26 October, 2018 where it is stated that such credit noted 'need not' be uploaded on the portal. As such, the GST paid on the original supply will be not be available to be adjusted;

- Once a credit note is issued, the details of the credit note should be declared by the supplier in the return of the month of the issue of credit note. However, if not declared in that month, it can be declared in any return prior to September of the year following the year in which the original tax invoice was issued (or filing of annual return, whichever is earlier);
- The supplier would not be permitted to claim reduction in the output tax liability if the incidence of tax and interest has been passed on to any person, or if the recipient fails to declare the details of the credit note in his returns;
- The issuance of credit note would not be relevant if the recipient treats the return of goods as an outward supply and raises a tax invoice in this regard;
- Credit note that is issued in any other circumstance (not permitted by section 34) would not be permissible and make itself indicate a cross-supply in the opposite direction (requiring an invoice under section 31). Care should be taken while examining any practice of issuing financial or accounting credit note that is not in accordance with section 34. Also note that as per table 5J in GSGTR 9C, such credit notes (not permitted by section 34) are to be separately reflected in the reconciliation and output tax must be shown to be paid on the original supply value.

(38) "debit note" means a document issued by a registered person under sub-section (3) of section 34;

A debit note should be issued by a supplier in the following circumstances:

- (a) The taxable value shown in the invoice is lesser than the taxable value of the supply; or
- (b) The tax charged in the invoice is less than the tax payable on the supply.

The following aspects need to be noted:

- Where there is no change in the taxable value/ tax amount, a debit note must not be issued;
- A debit note has to be issued by the supplier. A debit note issued by a recipient, say for accounting purposes, is not a relevant document for GST purposes;
- The details of the debit note have to be declared by the supplier in the return of the month of the issue of debit note;
- Debit note includes a supplementary invoice.

(39) “deemed exports” means such supplies of goods as may be notified under section 147;

Deemed exports are those supplies of goods that are notified as ‘deemed exports’ where:

- (a) The goods supplied do not leave India;
- (b) Payment for such supplies is received in Indian Rupees/ Convertible Foreign Exchange; and
- (c) Such goods are manufactured in India.

The definition of ‘deemed exports’ under this Act is in line with the definition of ‘Deemed Exports’ under Chapter 07.01 of the Foreign Trade Policy 2015-20. ‘Deemed Export’ under the FTP 2015-20 covers supply of goods to EOU/STP/EHTP/BTP, supply of goods under advance authorisation etc. and hence provides for refund, drawback and advance authorisation to the supplier of goods. On the other hand, the relevance of ‘deemed export’ under the GST laws is limited to the grant of refund of taxes on supply of goods as ‘deemed export’.

Therefore, a provision has been made under the Act to notify certain transactions as ‘deemed export’ to avoid situations where the persons might claim refund of taxes on ‘deemed export’ defined in the FTP 2015-20. While deemed exports may be notified under section 147, the nature of benefit available in respect of deemed exports requires a provision in the Act conferring such entitlement. Section 54 would be the machinery provision for disposal of refund applications. And deemed exports will not come within section 54(3).

(40) “designated authority” means such authority as may be notified by the Board;

Currently, the term does not find a reference in the Act and will be notified by the Board from time to time.

(41) “document” includes written or printed record of any sort and electronic record as defined in clause (t) of section 2 of the Information Technology Act, 2000;

An electronic record, in terms of Section 2(t) of the Information Technology Act, 2000 means data, record or data generated, image or sound stored, received or sent in an electronic form or micro film or computer generated micro fiche. A document includes both manual and electronic forms of records. This is an important provision that can play a significant role going forward bringing various electronic communications within the scope of admissible documentary proof of the underlying transaction. Digitally signed documents are also admissible but using words such as ‘the season electronically generated document and does not require signature’ do not enjoy the status of being a admissible document.

(42) “drawback” in relation to any goods manufactured in India and exported, means the rebate of duty, tax or cess chargeable on any imported inputs or on any domestic inputs or input services used in the manufacture of such goods;

This is relevant to understand the contours of refund under the GST laws. Refund of unutilized input tax credit is allowed in case of zero-rated supplies (including exports) and inverted tax

rate structure. The law provides that refund of unutilized input tax credit will not be allowed if the supplier has availed drawback of such tax.

(43) "electronic cash ledger" means the electronic cash ledger referred to in sub-section (1) of section 49;

Electronic cash ledger means a cash ledger maintained in electronic form by each registered person. The amount deposited through various modes of payment (viz., internet banking, debit/ credit cards, NEFT/ RTGS or by any other mode), shall be credited to the electronic cash ledger. The amount available in this ledger can be used for the payment of:

- (a) Tax
- (b) Interest
- (c) Penalty
- (d) Fees or
- (e) Any other amount payable.

(44) "electronic commerce" means the supply of goods or services or both, including digital products over digital or electronic network;

Physical stores/ outlets that supply goods or services or both with the help of a digital network which is facilitated by a third party will fall within the scope of this definition. Electronic commerce is not to be understood as the activity of the operator of the digital network alone. Some experts believe that there is a certain amount of ambiguity as to whether a platform run by a person to supply own goods or services would also be covered in this definition.

Digital or electronic network does not always mean website on mobile app. A telephone network or a call centre using the fancy/easy number can also constitute digital or electronic network.

(45) "electronic commerce operator" means any person who owns, operates or manages digital or electronic facility or platform for electronic commerce;

It includes every person who, directly or indirectly, owns, operates or manages a digital/ electronic facility or platform for supply of goods or services or both. There is a certain ambiguity as to whether persons engaged in supply of such goods or services on their own behalf would also be covered in this definition.

While an aggregator (Ola, Swiggy, etc.) only connects the customer with the supplier/ service provider, an e-commerce operator (Flipkart) facilitates the entire process of the supply of goods/ provision of service. Under the GST law, even aggregators would be covered under the definition of 'electronic commerce operator'. Where such operators fall within the operation of 'agent' under schedule I, then the fiction under section 7(1)(c) would prevail and operate. Care must be taken to identify which activities of the enterprise falls within section 9(5) or section 52 and which ones under the said fiction of schedule I.

Setting up a website by a supplier for 'own use' also comes within the scope of this definition however the compliances that are triggered by being such an electronic commerce operator under section 52 cannot be attracted unless there are three distinct persons – customer, supplier and electronic commerce operator. A supplier creating an online channel for sale of product in addition to his off-line retail chain of stores is included in the definition of electronic commerce operator. The implications of being an electronic commerce operator will apply in such cases only if the distinct person who owns or manages the electronic or digital network and the distinct person who stores and distributes the product are independent of each other. Also, every internet-linked transaction would not be ecommerce as the website may merely be an information portal without concluding any specific transaction of supply.

It may be noted that the threshold limits for registration would not apply and he would be required to obtain registration irrespective of his turnover;

(46) "electronic credit ledger" means the electronic credit ledger referred to in sub-section (2) of section 49;

Electronic credit ledger means the input tax credit register required to be maintained in an electronic form by each registered person. As a process, based on details of outward supplies filed by the suppliers, the electronic credit ledger of the recipient of goods/ services would be auto populated in the GSTN under the categories matched, un-matched and provisional. The tax payer claiming input credits should review the same and accept the relevant ones for claiming input credit.

The electronic credit ledger will be debited with the amount of tax liability so adjusted against the input tax credit lying in the ledger, and will stand reduced to the extent of the claim of refund of unutilised input tax credit, if any.

The amount of CGST credit available in this ledger can be used only towards discharging the liability on account of output tax under CGST/ IGST/ UTGST law only. Similarly, the amount of credit of other GST taxes can be used only towards discharging the liability of taxes under the GST laws, and not towards payment of interest, penalty or other sums due.

It is relevant to note that since 'output tax' excludes tax payable under reverse charge basis, some experts are of the view that the tax payable under reverse charge basis must be discharged by cash only and credit cannot be utilized for discharging such a liability.

(47) "exempt supply" means supply of any goods or services or both which attracts nil rate of tax or which may be wholly exempt from tax under section 11, or under section 6 of the Integrated Goods and Services Tax Act, and includes non-taxable supply;

The meaning of exempt supply is like the meaning assigned to it under the UTGST law with the exception that supplies that are partly exempted from tax under this Act will not be considered as 'exempt supply'. On the contrary, partially exempted supplies would be considered as 'exempt supplies' under the UTGST Act.

Exempt supplies comprise the following 3 types of supplies:

- (a) Supplies taxable at a 'NIL' rate of tax;
- (b) Supplies that are wholly exempted from CGST or IGST, by way of a notification. Please note that supplies liable to concessional rate of tax u/n 11/2017-CT(R) wherein explanation 4(iv)(b) states that such supplies are to be treated 'as if' exempt supplies but only for purposes of credit reversal under section 17(2) of CGST Act. Therefore, care must be taken to include only those supplies that are wholly exempt from tax and not partly exempt as discussed *ibid*; Non-taxable supplies as defined under Section 2(78) – supplies that are not taxable under the Act (viz. alcoholic liquor for human consumption).

The activities covered under Schedule III which are neither a supply of goods nor a supply of services would not be included in exempt supply. Examples- Services provided by employees to employer, sale of land or completed building, etc.

Note: The definition of exempt supply for the purpose of reversal of input tax credit is different. Refer to explanations under section 17(3), rule 42 and after rule 45. The following aspects need to be noted:

- Zero-rated supplies such as exports would not be treated as supplies taxable at 'NIL' rate of tax;
- Input tax credit attributable to exempt supplies will not be available for utilisation/ set-off.
- Also, please note that 'sale of business as going concern' is treated as a supply of services (even though it involves goods like inventory or assets). This is an exempt supply under sl.no.2 to 12/2017-CT(R) but para 4(c) to schedule II eclipses this specific transaction from being treated as one or other form of supply. With the credit being permitted to be transferred by 18(3), it appears that this is one example of a supply, although expressly exempt, would 'not' require reversal of credit under 17(2).

(48) "existing law" means any law, notification, order, rule or regulation relating to levy and collection of duty or tax on goods or services or both passed or made before the commencement of this Act by Parliament or any Authority or person having the power to make such law, notification, order, rule or regulation;

This covers all the erstwhile Central and State laws (along with the relevant notifications, orders, and regulations), relating to levy of tax on goods or services like Service Tax law, Central Excise law, State VAT laws, etc. Therefore, laws that do not levy tax or duty on goods or services, such as the Indian Stamp Act, 1899, would not be covered here.

(49) "family" means, —

- (i) the spouse and children of the person, and
- (ii) the parents, grand-parents, brothers and sisters of the person if they are wholly or mainly dependent on the said person;

The relevance of the term 'family' is to:

- Understand whether two persons are related persons under the Act and the consequential valuation provisions applicable in case of related persons;
- Examine whether a person is an agriculturalist as defined under Section 2(7) of the Act.

(50) "fixed establishment" means a place (other than the registered place of business) which is characterised by a sufficient degree of permanence and suitable structure in terms of human and technical resources to supply services, or to receive and use services for its own needs;

The following three elements are critical to determine whether a place is a 'fixed establishment':

- (a) Having a sufficient degree of permanence;
- (b) Having a structure of human and technical resources; and
- (c) Other than a registered place of business.

The following aspects need to be noted:

- A fixed establishment refers to a place of business which is not registered;
- But one where the person undertakes supply of services or receives and uses services for own needs in such place;
- Not every temporary or interim location of a project site or transit-warehouse will become a fixed establishment of the taxable person. Such project site or warehouse will not automatically become FE. Factors such as premises in occupation, staff locally employed for sufficient duration, administrative establishment to make nearly independent decisions to 'supply and receive' services and limited or specific extent of involvement from registered place of business are all relevant to make such determination;
- Temporary presence of staff in a place by way of a short visit to a place or so does not make that place a fixed establishment. Even extended duration of site camp may not meet the requirements to constitute FE by itself;
- E.g.: A service provider in the business of renting of immovable property services has his registered office at Bangalore (place of business) and the property for rent along with an office is located in Chennai (place of supply). In this case, the registered office will be the principal place of business but the property in Chennai will NOT be regarded as a fixed establishment of the service provider as the degree of permanence required in representing the interests of the supplier does not exist in Chennai.
- E.g.: A contract is for supply and installation of equipment where the duration of installation work at the site is (say) 15 days at Indore and the fabrication of equipment undertaken at the factory at Jaipur. After the fabrication is completed, the material is

transported to the site along with installation team. For the limited duration that the installation team will be present at the site (Indore), surely the supplier will not put in place all the resources – technical and human – so as to create at the site an establishment with sufficient degree of permanence ‘to supply’ or ‘to receive’ services. In this case also, the factory will be the principal place of business (Jaipur) but the site (Indore) will NOT be regarded as a fixed establishment of the supplier.

- E.g.: A project undertaken for construction of a highway (expansion, strengthening and resurfacing of two-lane carriageway into four-lane carriageway) is expected to be undertaken over a three-year duration in Gandhidham. As such, the supplier cannot practically manage to undertake the activities that the project site (entire length of the alignment) remotely from the registered office in Delhi. Although all decisions are authorized by the central team in Delhi, these decisions are effectively delegated to be carried out by its competent team located at the site with all necessary resources – technical and human – so as to create at the site an establishment with sufficient degree of permanence ‘to supply’ or ‘to receive’ services. In this case, the site (Gandhidham) would be a fixed establishment of the supplier.

(51) “Fund” means the Consumer Welfare Fund established under section 57;

This refers to the Consumer Welfare Fund constituted by the Government where the unutilized input tax credits of a person will be credited if an application to that effect has been made. The amount will be credited to the Fund only upon an order being passed by the Proper Officer after being satisfied that the amount claimed as refund is refundable.

(52) “goods” means every kind of movable property other than money and securities but includes actionable claim, growing crops, grass and things attached to or forming part of the land which are agreed to be severed before supply or under a contract of supply;

The following aspects need to be noted:

- Although various courts have held that the term ‘goods’ includes actionable claim under the VAT laws, as trade practice, actionable claims were kept outside the taxation net under the earlier laws. Now, the GST law seeks to change this understanding by including actionable claim in the definition of goods. Thus, under GST laws, actionable claims would be goods;
- The words ‘but includes’ is an exception to the “exclusion” of money and securities. In other words, if the actionable claim represents property that is money or securities, it can be held that such forms of actionable claims continue to be excluded;
- Actionable claim, other than lottery, betting and gambling will not be treated as supply of goods or services by virtue of Schedule III (Activities or transactions which shall be treated neither as a supply of goods nor a supply of services);
- Intangibles like MEIS/SEIS scrips, copyright and carbon credit would continue to be covered under ‘goods’.

(53) *“Government” means the Central Government;*

(54) *“Goods and Services Tax (Compensation to States) Act” means the Goods and Services Tax (Compensation to States) Act, 2017;*

The Goods and Services Tax (Compensation to States) Act (for brevity “Compensation Act”) provides for compensation to the States for the loss of revenue arising due to implementation of GST for a period of 5 years from the said date of implementation. The cess paid on the supply of goods or services will be available as credit for utilization towards payment of said cess on outward supply of goods and services on which such cess is leviable.

(55) *“goods and services tax practitioner” means any person who has been approved under section 48 to act as such practitioner;*

A goods and service tax practitioner (GST practitioner) is a person who can undertake the following activities on behalf of a registered person (if so authorized):

- (a) Furnish details of outward and inward supplies;
- (b) Furnish monthly, quarterly, annual or final return;
- (c) Make deposits in the Electronic Credit Ledger;
- (d) File a claim for refund;
- (e) File an application for amendment/ cancellation of registration.

The following aspects need to be noted:

- A person desirous of being enrolled as a GST Practitioner should make an application in Form GST PCT-1 and satisfy the conditions required;
- The GST practitioner is required to affix his digital signature on the statements prepared by him/ electronically verify using his credentials;
- The responsibility of correctness of the details furnished will lie on the registered person only.

(56) *“India” means the territory of India as referred to in article 1 of the Constitution, its territorial waters, seabed and sub-soil underlying such waters, continental shelf, exclusive economic zone or any other maritime zone as referred to in the Territorial Waters, Continental Shelf, Exclusive Economic Zone and other Maritime Zones Act, 1976, and the air space above its territory and territorial waters;*

The definition of India extends not only to the landmass, but also to the territorial waters and the air space above the Indian territory and territorial waters. Hence, all the supplies made in such areas will be treated as supplies made in India. Unlike earlier laws, GST redraws the map of India as commonly understood to a map that extends beyond the land mass well into the sea all the way to the end of the maritime zone (200 nautical miles from baseline on the shore at high-tide) going down under the sea bed and sub soil under such waters and up in the air up to the air space (sovereign air space) above. Sovereign air space is based on the

jurisdiction of a nation's laws and there are 11 nations that have such laws. India is in the process of putting together its own air space legislation. Beyond the maritime zone or above sovereign air space is called 'high seas' in maritime law.

E.g.: Musical performance by an artist on board a ship sailing from Chennai to Vishakhapatnam, food supplied on an aircraft flying from Delhi to Trivandrum.

(57) *"Integrated Goods and Services Tax Act"* means the *Integrated Goods and Services Tax Act, 2017*;

It refers to the Act which provides for principles to determine what is an inter-State or intra-State supply, and levy of tax on inter-State supply of goods or services or both (other than supply of alcoholic liquor for human consumption).

(58) *"integrated tax"* means the *integrated goods and services tax levied under the Integrated Goods and Services Tax Act*;

Tax levied under the IGST Act is referred to as "Integrated tax". It refers to the tax charged under the IGST Act on inter-State supply of goods or services or both (other than supply of alcoholic liquor for human consumption). The rate of tax is capped at 40% and will be notified by the Central Government based on the recommendation of the Council.

(59) *"input"* means *any goods other than capital goods used or intended to be used by a supplier in the course or furtherance of business*;

The term "input" refers to goods as defined under the GST law, and excludes capital goods. Unlike the definitions given to the term "capital goods" in the erstwhile laws such as Central Excise, VAT, etc., the term is given a very simple meaning in the GST law.

It is sufficient for any goods which are used or intended for use in the course or furtherance of business to be capitalised in the books of account, for them to be treated as capital goods under GST. Accordingly, if a person who is engaged in the sale of laptops capitalises one laptop in his books of account, and such laptop is for business-use, (say for invoicing purposes), that laptop shall be treated as capital goods under GST law as well.

The second condition for goods to be treated as inputs, is that they must be used or intended to be used by the person who has inwards (say by way of purchase, exchange, etc.) those goods '*in the course or furtherance of business*'. This phrase encompasses a wide range of functions within the business.

- The term "business" as defined under the GST law includes any activity or transaction which may be connected, or incidental or ancillary to the trade, commerce, manufacture, profession, vocation, adventure, wager or any other similar activity.
- There is neither a requirement of continuity nor frequency of such activities or transactions for them to be regarded as 'business'.
- The law poses no restriction that the goods must be used on the shop floor, or that they must be supplied as such/ as part of other goods/ services. It would be sufficient if the goods are used in the course of business, or for furthering the business.

- The term 'course of business' is one that can be stretched beyond the boundaries consolidating activities that have direct nexus to outward supply. What is usually done in the ordinary routine of a business by its management is said to be done in the "course of business". Moreover, the term "ordinary" is missing before "course" in the phrase.
- From the above, it can be inferred that the purchase/ inward supply of goods need not be a regular activity, and may even be a one-time procurement. This is further clarified with the other phrase "furtherance of business", which has not been of use in the indirect taxes thus far.
- "Furtherance of business" is a new term, and an entirely new concept, that has been introduced in GST.

Additionally, there is no other condition attached to the term "input", especially in relation to the outward supply. Consequently, a person engaged in supplying services would also be entitled to treat the goods inwarded as "inputs", where the conditions of not being capital goods, and the usage in the course or furtherance of business, Thus, laptops procured by a supplier of pure services which are meant for use of the employees for business making reports, will be eligible to be treated as "inputs" for such a person, and consequently, the taxes paid on such goods will be available as credit to the service provider, on meeting other conditions mandated for claiming credit.

Further, the law provides a flexibility for this purpose by inserting the words "or intended to be used" before "in the course...". By this, the law secures the meaning of the term "input" even for cases where goods have been purchased but, are yet to be used in the business. Thus, the conditions of *ready-to-use* and *put-to-use* would not be relevant for considering goods as "inputs", unless the condition takes route through rules/ other sections. However, no such conditions appear even for claiming input tax credit.

(60) "input service" means any service used or intended to be used by a supplier in the course or furtherance of business;

Any services that is used or intended to be used by a supplier of goods or services, or both, in the course or furtherance of business would be treated as "input service".

The meaning of the term "service" under the GST law is very vast to include everything that is not goods, barring securities, and monies that do not amount to activity relating to the use of money or conversion of money. Therefore, anything received by a person who is a supplier, which is not goods, and is neither securities nor money as such, would be treated as 'input service', so long as it is used or meant to be used in the course or furtherance of business.

Unlike the erstwhile law, there is no requirement for it to have direct nexus with the outward supply. In other words, the service received may not be directly linked to the outward supply of the supplier receiving the service, and the outward supply may be goods or services. Regardless of the outward supply, the service received would qualify as "input service" to him, when the same is used in the course or furtherance of business. Therefore, a retailer who

receives housekeeping services of the business premises will be eligible to treat the services as 'input services' given that such services are received in due course of business.

Further, while the erstwhile law required that the services must be received only up to the place of removal for them to qualify as "input services", there is no such condition attached to the term under GST, where such services are received in the course or furtherance of business. This means that goods transportation services availed by the supplier, would qualify as input services to him, even if the transportation is up to the place of delivery to the recipient, say the factory of the recipient, although the transportation does not add value to the goods itself, but adds value to the supply made by him.

Contrasting with the definition of capital goods (capitalized in books) and inputs (not capitalized in books or revenue expense), input service does not appear to be restricted to revenue expenditure only, but may also be capitalized in books,

(61) "Input Service Distributor" means an office of the supplier of goods or services or both which receives tax invoices issued under section 31 towards the receipt of input services and issues a prescribed document for the purposes of distributing the credit of central tax, State tax, integrated tax or Union territory tax paid on the said services to a supplier of taxable goods or services or both having the same Permanent Account Number as that of the said office;

The concept of input service distributor exists even in the earlier service tax law. This has been borrowed into GST, entitling a person who is registered as an Input Service Distributor (ISD) to distribute the credit in respect of input services (and not inputs) received in its name. Given that services are intangible, it is not practicable to trace every service to the ultimate recipient of the service, as is distinguishable in case of goods, justifying the need for a distributor to services.

The definition appears to indicate that the ISD-office cannot simultaneously be a place of business from where taxable supplies are made. In other words, if there is a place of business of a taxable person, that office cannot also be an office that 'receives tax invoices and issues document to distribute credit). Although some experts do not find any apparent objection for cohabitation of POB and ISD. But, in view of the inter-branch supply of management and supervisory services by an office that has such capabilities, treating such an office as ISD would be misapplication of the facility of ISD to distribute credit.

Generally, the head office of the person, or the corporate office, by whatever name called, would be the location to which the services would be billed. However, there is no implication by law that an ISD must be the head office. It may be ensured that the office registered as ISD does not itself undertake any activity in the nature of outward supply, not receive inward supplies of its own or not attract RCM liability. Therefore, a single company may choose to have multiple regional offices based on its business requirements.

To distribute the credit of input services, the ISD would be required to follow the manner prescribed by the rules, including:

- Issue of an ISD invoice to each recipient of credit on every distribution.
- Recipients of credit to are those taxable persons to whom it is attributable (whether or not they are registered), being persons having the same PAN (as issued under the Income Tax Law) as that of the ISD.
- The credit of integrated tax should be distributed as integrated tax irrespective of the location of the ISD, and so also:
 - Where the ISD is located in a State other than that of the recipient of credit, the aggregate of Central tax, State tax and Union territory tax, as integrated tax.
 - Where the ISD is located in the same State as that of the recipient, the Central tax and State tax (or Union territory tax) should be distributed as the Central tax and State tax (or Union territory tax), respectively.
- Each type of tax must be distributed through a separate ISD invoice. However, there is no requirement to issue ISD invoices at an invoice-level (received from the supplier of the service).

Note: The liability to cross charge for services provided between distinct persons (branches/ HO etc.) is independent from the function of the ISD.

(62) "input tax" in relation to a registered person, means the central tax, State tax, integrated tax or Union territory tax charged on any supply of goods or services or both made to him and includes—

- (a) the integrated goods and services tax charged on import of goods;*
- (b) the tax payable under the provisions of sub-sections (3) and (4) of section 9;*
- (c) the tax payable under the provisions of sub-sections (3) and (4) of section 5 of the Integrated Goods and Services Tax Act;*
- (d) the tax payable under the provisions of sub-sections (3) and (4) of section 9 of the respective State Goods and Services Tax Act; or*
- (e) the tax payable under the provisions of sub-sections (3) and (4) of section 7 of the Union Territory Goods and Services Tax Act,*

but does not include the tax paid under the composition levy;

From the opening of the definition, it can be understood that input tax can arise only in respect of registered persons, and the tax is only available on supplies **made to him**. Therefore, no tax paid on outward supplies can ever qualify as input tax to the person making the supply (who may or may not be registered), and shall only be treated as 'input tax' by the person receiving the supplies.

The law also makes it amply clear that input tax is linked to a specific registration, and cannot be loosely associated with various GST registrations of the single legal person.

Further, for 'input tax', the law makes no distinction between Central tax, State tax, Union territory tax and integrated tax.

The law specifically provides certain inclusions and an exclusion to clarify the scope of the term:

- The specific inclusions are of two types, i.e., the integrated tax applicable on import of goods (in lieu of the previously applicable CVD and SAD), and the taxes payable on reverse charge basis on account of supplies being those supplies that are notified in this regard, or on account of being inward supplies from unregistered persons. From the language used, it must be understood that these inclusions are not limited to those that have been discharged, on the premise that the law used the words "charged" or "taxable" and not "paid".
- While it is clear that composition suppliers will not be entitled to collect taxes, from this definition, it can be inferred that the amounts paid by composition in lieu of tax, cannot, in turn, be treated as input tax either for the composition supplier or for the recipient of the supplies.

Further, the GST Compensation law reserves right to levy cess on certain supplies. However, this cannot be treated as input tax for the purposes of GST. Although the GST Compensation law provides that the provisions of input tax would apply *mutatis mutandis* to cess, it categorically specifies that the input credit of cess can only be utilised for discharging the liability on such cess.

(63) "input tax credit" means the credit of input tax;

For a tax to qualify as "input tax credit", it must first be "input tax". The law creates a separate terminology for this purpose as all input tax would not qualify as credit. Credit of input tax would be available subject to specific conditions and restrictions, and to specific persons being registered persons.

(64) "intra-State supply of goods" shall have the same meaning as assigned to it in section 8 of the Integrated Goods and Services Tax Act;

The principles for determining a supply as an intra-State supply are provided in the IGST law in terms of the exclusive power of Parliament under article 269A(5) of our Constitution.. Drawing reference to the relevant Section, every supply of goods, where the location of the supplier of the goods and the place of supply as determined under Section 10 of the Act, are in the same State (or same Union Territory), would be an intra-State supply of such goods. Accordingly, an import or export of goods can never be an intra-State supply.

Every taxable supply that is an intra-State supply shall be liable to both Central tax and the respective State tax (or Union territory tax), unless otherwise exempted.

The 'place of supply' referred to in this regard is a legal terminology and should not be understood for the colloquial usage, if any. Section 10 of the IGST Act provides situation-specific conditions for determining the 'place of supply'.

(65) "intra-State supply of services" shall have the same meaning as assigned to it in section 8 of the Integrated Goods and Services Tax Act;

As in case of goods, where the location of the supplier of the service and the place of supply as determined under Section 12 of the IGST Act, are in the same State (or same Union Territory), the supply would be an intra-State supply of such services. Import of goods under a cross-border lease arrangement attracts levy of customs duty (for the physical article brought into India) and also attracts levy of GST (for the treatment of lease as a supply of service under para 1(b) or 5(f) of schedule II). Please look for specific exemption under Customs law in case of cross-border lease arrangement to deal with the overlap of levy under both these legislations. Eg. Sl.no.547A to NN 50/2017-Cus. dated 30 June, 2017 by NN 65/2017-Cus. dated 8 July, 2017 or 72/2017-Cus. dated 16 August, 2017, etc.

Every taxable supply of service that is an intra-State supply shall be liable to both central tax and the respective State tax (or Union territory tax), unless otherwise exempted. The 'place of supply' should be determined in accordance with Section 12 or Section 13, as the case may be, of the IGST Act that provides situation-specific conditions for determining the 'place of supply'.

Note: Section 13 of the IGST Act specifies the conditions for determining place of supply in cases where either the location of the supplier or the location of the recipient (or both) are located outside India.

(66) "invoice" or "tax invoice" means the tax invoice referred to in section 31;

On a plain reading of the law, it appears that the terms "invoice" and "tax invoice" have been used inter-changeably to refer to that document that is prescribed by law, as a document that shall be issued by the registered person on making taxable supplies. The tax invoice should contain all the prescribed details such as the description of the goods, quantity, value and tax charged on the supply. The possibility of denial of credit due to prescribed details not being available even if not important is real unless law provided for condonation which was there in earlier laws.

- In respect of goods: A tax invoice can be issued at or before the time of removal of the goods for making the supply, where the supply involves movement of the goods (either by the supplier or by the recipient, or any other person).
 - However, where the supply to the recipient does not involve movement of the goods, the tax invoice would be due at the time of delivery or making the goods available to the recipient. It is not necessary that every supply requires movement of goods on the basis that all goods are movable in nature.
 - The time of removal would matter only in cases where the removal of goods and the movement of goods is by virtue of the supply.
 - Consider the case of sale on approval basis. Goods would be removed at a certain time, and may be delivered to the location of the recipient. However, it is

not known at the time of removal, whether the transaction results in a supply. Therefore, the time of confirmation by the recipient that he wishes to retain the goods would be the due date for issuing the tax invoice.

- The Government is also empowered to notify certain categories of supplies in respect of which it can prescribe a separate time limit for issuance of tax invoice.
- In respect of services: A tax invoice for supplying services should be issued within 30 days from the date of supply of the taxable service.
 - However, the Government is empowered to notify certain categories of services wherein any other document relating to the supply would be treated as the tax invoice, or for which no tax invoice is required to be issued at all.

The provisions of Section 31 of the CGST Act also provide for invoices or other documents such as bill of supply, payment voucher, receipt voucher, etc. in for specific situations.

(67) "inward supply" in relation to a person, shall mean receipt of goods or services or both whether by purchase, acquisition or any other means with or without consideration;

Inward supplies may be of goods or of services, or of both. The key in this definition is to note that 'inward supply' is not necessarily a supply and has a larger scope by covering 'receipt' of goods or services.

It may be questioned as to whether an inward supply is not particular to a registration, or whether an inward supply can be associated with any of the registered persons having the same pan, on the premise that it is in relation to "a person". However, that would not be the intent of the law; it is to enable correlation with a person, whether or not he is a taxable person. In other words, reference to inward supply may be in relation to any person, whether he is registered, or unregistered taxable person, or person not liable to tax.

(68) "job work" means any treatment or process undertaken by a person on goods belonging to another registered person and the expression "job worker" shall be construed accordingly;

To start with, the expression "job work" refers to a "treatment" or "process", which is undertaken by one person, who may or may not be registered, to another registered person.

While treatment and processing are commonly understood as services, there is no implication that job work is purely services, or that goods would not be used for such treatment or processing. However, Schedule II of the CGST Act which specifies activities to be treated as supply of goods or supply of services, *inter alia* provides that any treatment or process which is applied to another person's goods is a supply of services. Such a deeming fiction in respect of job work is given effect to, based on the primary objective of any job work, which is to provide a service.

The following aspects need to be noted:

- Capital goods may be sent for job work, or for the purpose of carrying out the treatment or process.

- A job worker is free to effect inward supplies on his own account for carrying out the job work. The law does not require that goods applied for the treatment or process must also be sent by the registered person on whose goods the job work is undertaken.
- As regards the job worker *per se*, the law makes no insistence that such person must be a registered person.
- The law requires that the treatment or process undertaken by the job worker must be on goods belonging to “another” registered person.
 - From the usage of the term “another” before “registered person”, it is clear that the law intends to segregate the units being different persons, or different registrations.
 - The reference to the principal is made by using “another registered person” and not “another person”.
 - It may be safely be understood that, if one unit of a company supplies goods for further processing to another unit of the same company, having a different registration from that of the supplying unit, the unit undertaking the processing activity can be treated as a job worker.
- If the Principal is an unregistered person, then the job worker is not a job worker. Classification of the work undertaken may need to be examined whether it is manufacture or not to attract the appropriate rate of tax applicable to the goods so manufactured and not rate of tax applicable to services of job-work;
- Job work should not be interchanged with repair activity as both appear to involve ‘treatment or process’ on goods belonging to another. Job work brings into existence a functionality that was not in existence whereas repair restores functionality that was already in in existence before the article became faulty (and needed repairs).
- is important to note that the job worker is not an Agent of the Principal and the relationship *inter se* are that of Principal to Principal.

(69) “local authority” means—

- (a) a “Panchayat” as defined in clause (d) of article 243 of the Constitution;
- (b) a “Municipality” as defined in clause (e) of article 243P of the Constitution;
- (c) a Municipal Committee, a Zilla Parishad, a District Board, and any other authority legally entitled to, or entrusted by the Central Government or any State Government with the control or management of a municipal or local fund;
- (d) a Cantonment Board as defined in section 3 of the Cantonments Act, 2006;
- (e) a Regional Council or a District Council constituted under the Sixth Schedule to the Constitution;

- (f) a Development Board constituted under article 371 **and article 371J**⁶ of the Constitution; or
- (g) a Regional Council constituted under article 371A of the Constitution;

A 'local authority' is also a 'person' for the GST law. A local authority would enjoy the same treatment as is received by a 'Government' such as in the case of supplies that shall be treated as neither a supply of goods nor a supply of services, requirement to deduct tax at source on supplies made to it, etc.

Understanding Government, Government Agency, Government Entity and Local Authority assumes significance consider TDS obligations under section 51 (on payments by such entities) and RCM obligations (on recipient of services from such entities). Some considerations may be to examine schedule XI and XII of our Constitution about functions of sovereign. Another could be to examine if employees of such entities are employees of the President of India or Governor of the State. Yet another could be to examine if, in the event of liquidation of such entity, whether the liquidation estate will vest with the Union or State and be transferrable to the Consolidated Fund of India or State. These and such other facts may need to be examined understanding to decide whether the entity or board or corporation would be a Government functionary.

- (70) "location of the recipient of services" means, —
- (a) where a supply is received at a place of business for which the registration has been obtained, the location of such place of business;
- (b) where a supply is received at a place other than the place of business for which registration has been obtained (a fixed establishment elsewhere), the location of such fixed establishment;
- (c) where a supply is received at more than one establishment, whether the place of business or fixed establishment, the location of the establishment most directly concerned with the receipt of the supply; and
- (d) in absence of such places, the location of the usual place of residence of the recipient;

Given that services are not tangible, the determination of the location of the recipient of service could result in complications. The 'location of the recipient of services' is essential to determine whether the supply is an inter-State or an intra-State supply, as such location is the residuary clause for determining the place of supply of services.

Broadly, the meaning given to the phrase "location of the recipient of services" is oriented towards determining the place of supply of the services. The most relatable location of the recipient can be determined in the following order – if the place of supply of the service happens to be:

- (a) a 'place of business' which is a registered place of business, such place;

⁶ Inserted vide The Central Goods and Services Tax Amendment Act, 2018 w.e.f. 01.02.2019

- (b) a 'place' which is a fixed establishment (i.e., a place of business not registered, but having a sufficient degree of permanence involving human and technical resources), such fixed establishment;
- (c) at multiple 'places' which may include places of business or fixed establishments, that one place to which the supply is most directly attributable;
- (d) a place that cannot be identified from the above three clause, the usual location of the recipient (address where the person is legally registered/ constituted in case of recipients other than individuals).

(71) "location of the supplier of services" means, —

- (a) where a supply is made from a place of business for which the registration has been obtained, the location of such place of business;
- (b) where a supply is made from a place other than the place of business for which registration has been obtained (a fixed establishment elsewhere), the location of such fixed establishment;
- (c) where a supply is made from more than one establishment, whether the place of business or fixed establishment, the location of the establishment most directly concerned with the provisions of the supply; and
- (d) in absence of such places, the location of the usual place of residence of the supplier;

The determination of the location of the supplier of services is equally complicated, as is in case of the recipient. The 'location of the supplier of services' is principally essential to determine whether the supply is an inter-State or an intra-State supply (i.e., where location of supplier and place of supply are in the same State or Union Territory, the supply would be an intra-State supply, and will be an inter-State supply in any other case).

Location of supplier 'of goods' is not defined in the CGST Act and does not seem to be a drafting oversight but a deliberate omission. Please refer to discussion in this regard in the context of section 7 and section 10 of IGST Act.

(72) "manufacture" means processing of raw material or inputs in any manner that results in emergence of a new product having a distinct name, character and use and the term "manufacturer" shall be construed accordingly;

The meaning of the term "manufacture" comes with a great deal of significance in the erstwhile indirect tax regime, given that chargeability excise duty relies solely on whether an activity results in manufacture. However, in the GST regime, the taxable event is a "supply" and tax is leviable whether or not the supply followed 'manufacture' of goods. Hence, the term loses its significance in the GST regime. However, a definition has been provided as references to this term are inadvertently essential even in the GST law, listed below:

- Composition levy: The composition tax rate in case of manufacturers is different as compared to that of suppliers not being manufacturers (expected cap rate of 2% as

against 1%, respectively, being the aggregate of central and State tax/ Union Territory tax). Further, manufacturers of certain notified goods would not be eligible to exercise the option to avail the benefit of composition scheme. Such a restriction is however, not placed on other classes of persons, say traders of the same notified goods.

- Concept of deemed exports: One of the pre-conditions for any such supply to qualify as deemed export is that the goods in question must be manufactured in India. Therefore, even where the goods are of the nature that are notified by the Government as goods that qualify as “deemed exports” on meeting certain conditions, if such goods are not manufactured in India (or, any processing performed on any imported goods does not result in manufacture), they cannot enjoy the benefit of the deeming fiction.
- Maintenance of accounts: A manufacturer shall be required to maintain a record of production/ manufacture of goods, in addition to recording the details of inward and outward supplies.

(73) “market value” shall mean the full amount which a recipient of a supply is required to pay in order to obtain the goods or services or both of like kind and quality at or about the same time and at the same commercial level where the recipient and the supplier are not related;

This term finds reference only in the provisions in relation confiscation of goods or conveyance arising on account of contravention of the provisions of the law (say supplies made by a taxable person who has failed to obtain registration, etc.). The law provides that the owner of the goods will be given an option to pay a fine, not exceeding the market value of the goods in question, to safeguard his goods or conveyance from being confiscated.

Goods or services of like kind and quality means *any other* goods or services (“comparables”) made under similar circumstances that, in respect of the characteristics, quality, quantity, functional components, materials, and reputation of the goods or services in question, is the same as, or closely or substantially resembles, that of the comparable.

The meaning of the term ‘related’, must be understood from the definition provided in respect of ‘related persons’ under Section 15.

This definition should not be confused with Open market value as this definition appears to be restricted to cases where there is confiscation where the value is from the recipients perspective.

(74) “mixed supply” means two or more individual supplies of goods or services, or any combination thereof, made in conjunction with each other by a taxable person for a single price where such supply does not constitute a composite supply.

Illustration: – A supply of a package consisting of canned foods, sweets, chocolates, cakes, dry fruits, aerated drinks and fruit juices when supplied for a single price is a mixed supply. Each of these items can be supplied separately and is not dependent on any other. It shall not be a mixed supply if these items are supplied separately;

When two (or more) goods, or two or more services (need not be taxable), or a combination of goods and services, that each have individual identity and can be supplied separately, are deliberately supplied for a single consolidated price, the supply would be treated as a mixed supply.

Most importantly, such a supply should not qualify as a composite supply, for it to be treated as a mixed supply, i.e., in case of a mixed supply:

- The two or more supplies are not naturally bundled and supplied conjointly in the ordinary course of business. In other words, unnaturally supplied inseparably and for a single price is a hallmark of mixed supply;
- The principal supply cannot be identified – more than one of the supplies form the “predominant element” of the supply. In other words, individually present but inseparably presented for supply would also yield tax being applied as mixed supply;

Where the conjoint supply is neither a composite supply, nor supplied for a single price, the two or more supplies would be treated as individual supplies or non-composite supply, and not as a ‘mixed supply’.

Illustrations for consideration:

- (a) Supply of toothpaste, brush, plastic container for the two: The three goods can be said to be naturally bundled and supplied in the ordinary course of business. While the plastic container is ancillary to the supply, both toothbrush and toothpaste could be the predominant elements of the supply. In a composite supply, there can be only one principal supply and therefore, this supply would be a mixed supply.
- (b) Supply of laptop and printer: Although a printer is used for the purpose of printing, the commands for which can be given through the laptop, the two goods are not naturally bundled and supplied conjointly in the ordinary course of business. Therefore, this supply is a mixed supply.
- (c) Supply of repair service for an accident vehicle for a single consolidated price.
- (d) Supply of combo-meal with aerated beverage or even alcoholic beverage.
- (e) Supply of lectures in a coaching centre and monthly excursions such as trekking, etc.: The two services are not naturally bundled in the ordinary course of business. Therefore, this supply is a mixed supply as it is for a single price.

The tax rates applicable in case of mixed supply would be the rate of tax attributable to that one supply (goods, or services) which suffers the highest rate of tax from amongst the supplies forming part of the mixed supply. Therefore, a mechanism for separating the supplies could be examined, in case of mixed supplies where tax rates are differing.

It is important to ensure there is a single price is assigned in respect of the various supplies that are involved. And the supplies so involved are unnaturally bundled together for such single price. If the price were not one single amount but the visible aggregation of individual

prices then, even if supplied together, each of them may be regarded as an individual non-composite supply.

(75) "money" means the Indian legal tender or any foreign currency, cheque, promissory note, bill of exchange, letter of credit, draft, pay order, traveller cheque, money order, postal or electronic remittance or any other instrument recognised by the Reserve Bank of India when used as a consideration to settle an obligation or exchange with Indian legal tender of another denomination but shall not include any currency that is held for its numismatic value;

The meaning attributed to this term in the GST law is a polished adoption of the definition provided under the Service Tax law. Additionally, money as defined in the GST law includes any foreign currency as well. The significance of this term is that it is out of the scope of taxation under GST. Money would neither be goods nor services under the GST law. However, there is no exemption given to activities relating to the use of money or its conversion. So also, sale of money, say a coin collection set of 100 coins, would be chargeable to tax, as such coins are held for their numismatic value.

It is also interesting to note that this term is no longer relevant for understanding whether a transaction is for consideration, as the meaning assigned to the term 'consideration' under the GST law may be in money or in another form.

The words "...or any other instrument recognised by the Reserve Bank of India..." demands a mention of the Payments and Settlement Systems Act, 2007 which allows RBI to authorize the development and distribution of a system of settlement of payments in the form of prepaid instruments (PPIs) that are not Indian legal tender but are yet used as a consideration to settle an obligation. Such PPIs are often confused with voucher (defined in section 2(119) below). This form of interchangeable usage would be an error. Since the PPI is included in the definition of money it cannot also be included in the definition of voucher. PPIs are not vouchers but money. Tax treatment applicable on the receipt of money must be applied even when receipt is through PPI's.

(76) "motor vehicle" shall have the same meaning as assigned to it in clause (28) of section 2 of the Motor Vehicles Act, 1988;

Replace with Section 2(28) of the Motor Vehicles Act, 1988 reads as under:

"motor vehicle" or "vehicle" means any mechanically propelled vehicle adapted for use upon roads whether the power of propulsion is transmitted thereto from an external or internal source and includes a chassis to which a body has not been attached and a trailer; but does not include a vehicle running upon fixed rails or a vehicle of a special type adapted for use only in a factory or in any other enclosed premises or a vehicle having less than four wheels fitted with engine capacity of not exceeding twenty-five cubic centimetres.

From this, it can be understood that all vehicles such as cars, trucks, buses, tempo-travellers, etc. that are meant for usage on roads will be covered within the meaning of 'motor vehicles'. The implication of this definition is that input tax credit is not available in respect of inward

supply of motor vehicles, unless they are used for specific purposes (being transportation of goods, or for making taxable supplies of further supply of such vehicles, or supplying passenger transportation services or for imparting training in relation to such vehicles). The denial of rent a cab (less than 12 persons) credit means that there is a need to examine the applicability of permits and its harmonious understanding with the Motor Vehicles Act.

When motor vehicle has been defined by reference to another Act, all interpretation that is allowed under that Act would equally apply under GST. Motor vehicles such as its excavators, wheel loaders, back hoe, road rollers, etc. will also come within the same restrictions applicable to motor vehicles under GST law. Merely because these articles are used more in the nature of plant and machinery and less in the form of motor vehicles is of no avail.

(77) "non-resident taxable person" means any person who occasionally undertakes transactions involving supply of goods or services or both, whether as principal or agent or in any other capacity, but who has no fixed place of business or residence in India;

The meaning of the term 'non-resident taxable person' covers all person who undertake transactions involving supply of goods or services or both, whether or not such supplies are taxable, so long as such person neither has a fixed place of business nor residence in India.

Every such person who intends to affect any taxable supplies under the GST law, should compulsorily obtain registration under the GST law before commencing business, irrespective of the turnover during the year. The application for registration shall be made at least 5 days prior to the commencement of business.

However, a person who does not undertake transactions involving any supplies "occasionally", he would not be treated as a non-resident taxable person. The law does not define the frequency implied by the expression "occasionally". Therefore, where there is a reasonable frequency of occurrence of supplies in India, it must be construed as transactions occurring occasionally.

Due to applicability of higher rate of withholding under Income-tax Act on remittances made from India, non-residents who have no active business presence in India are also found to have secured PAN numbers. And for this purpose has designated a representative with an address being either admitted premises of operations or simply for correspondence. Care must be taken to determine whether such designated representative and address would 'fixed place of business' (and not to be equated with fixed establishment).

(78) "non-taxable supply" means a supply of goods or services or both which is not leviable to tax under this Act or under the Integrated Goods and Services Tax Act;

A transaction must be a 'supply' as defined under the GST law, to qualify as a non-taxable supply under the GST law.

The following aspects need to be noted:

- Stock transfers to unit within the State for which no separate registration is obtained, which does not qualify as a 'supply' as defined under Section 7 of the CGST Act, cannot

be said to be a non-taxable supply.

- Transactions specified in Schedule III which are treated as neither a supply of goods nor a supply of services, would also qualify as non-taxable supplies.
- Receipts that satisfy exclusion from valuation as 'pure agent' (rule 33) would also be no supply and not to be treated as non-taxable supply.
- Supplies that enjoy the benefit of being wholly exempted from taxes, nil-rated supplies and zero-rated supplies are also not covered under the umbrella of 'non-taxable supplies' given that the goods or services are in fact liable to tax, and such tax is exempted by virtue of an exemption notification, or the tax rate is nil.
- Only those supplies that are excluded from the scope of taxation under GST are covered by this definition – i.e., alcoholic liquor for human consumption, articles listed in section 9(2) or in schedule III.

(79) "non-taxable territory" means the territory which is outside the taxable territory;

A taxable territory means the territory to which the provisions of the GST law applies. Accordingly, in case of CGST law, the taxable territory would cover all locations covered under the extent of the law – i.e., whole of India.

- Accordingly, locations outside India would be considered as non-taxable territory, being the territory outside the taxable territory.
- Similarly, for the State GST law, non-taxable territory would cover all those locations where the provisions of the particular State GST law would not apply. For instance, for the purpose of the State GST law of Maharashtra, all other States and Union Territories of India, and locations outside India, would be non-taxable territory.

In this regard, it would be relevant to understand the geographical extent covered within the meaning of the term 'India' – refer analysis of Section 2(56).

Supply taking place in a 'non-taxable territory' would be outside the jurisdiction for imposing any GST. High sea sales (first supply) are not liable to GST because goods that involve movement are located outside the taxable territory even though the recipient may be inside. Another example is Merchanting Trade (eg. Buy from China and Ship to Germany, directly by an Indian entity). GST is a tax on supply and not a tax on supplier. Supply that does not occur within taxable territory would be a non-taxable supply in the returns of this Indian entity.

(80) "notification" means a notification published in the Official Gazette and the expressions "notify" and "notified" shall be construed accordingly;

The Central Government and the State Governments are empowered to issue notifications to give effect to certain provisions such as goods and services that would be liable to tax on reverse charge basis, supplies that are exempted from tax, supply of goods that shall be treated as supply of services, etc. For a notification to be valid under GST, it must be published in the Official Gazette of India, as published by the Government of India's

Department of Publication, Ministry of Urban Development.

Every notification published in the Official Gazette will come into force from the date of such publication, unless another date is specified for this purpose, in the notification.

(81) "other territory" includes territories other than those comprising in a State and those referred to in sub-clauses (a) to (e) of clause (114);

By definition, the expression 'other territory' is inclusive of all territories that do not form part of any State (including the two Union Territories with Legislature being Delhi and Puducherry), and excludes the Union Territories (i.e., the Andaman and Nicobar Islands, Lakshadweep, Dadra and Nagar Haveli, Daman and Diu, and Chandigarh).

All territories that fall into the ambit of 'other territory' as defined above would also form part of the meaning of the term 'Union territory' as defined under Section 2(114), to leave no territory that is claimed by any of the States or Union Territories, outside the scope of taxation under GST, so long as such territory is in India. Although there is no specific explanation that the extent of the term should be limited to the territory of India, we should not consider locations outside India to also fall into the scope of 'other territory' defined above, as it would defeat the purpose of law.

(82) "output tax" in relation to a taxable person, means the tax chargeable under this Act on taxable supply of goods or services or both made by him or by his agent but excludes tax payable by him on reverse charge basis;

The output tax chargeable on intra-State taxable supply of goods or services can be summarised as under:

Type of Supply	Output tax	Reference
Supplies within a State (or UT with Legislature)	CGST + Specific SGST (intra-State supply)	Section 8(1) and 8(2) of the IGST Act
Supplies within a UT without Legislature	CGST + UTGST (intra-State supply)	Section 8(1) and 8(2) of the IGST Act

The following aspects need to be noted:

- While input tax is in relation to a registered person, output tax is in relation to a taxable person. Evidently, the law excludes persons who are not registered under the law from being associated with any input tax. However, where there is a liability due to the Government, the law paves the way to cover those persons who are liable to tax, but who have failed to obtain registration.
- The amount covered under this term is the amount of tax that is 'chargeable', and not the amount that is 'charged'. Therefore, in case a person wrongly charges tax, or charges an excess rate of tax, as compared to the applicable tax rate, such excess

would not qualify as output tax.

- Some experts are of the view that taxes payable by recipient of supply, on account of making inward supplies of such categories of supply as are notified for the purpose of reverse chargeability of tax, or making inward supplies from unregistered persons, would also be out of the scope of 'output tax'.
- The implication of the exclusions mentioned above is that the input tax credit cannot be utilised for making payment of any amount that does not qualify as output tax. Discharge of liability in such cases has to be by way of cash payments (i.e., through the electronic cash ledger, on depositing money by means of cash, cheque, etc.).
- The law makes a specific inclusion in respect of supplies made by an agent on behalf of the supplier, to treat the tax paid on such supplies as output tax in the hands of the supplier.
- 'Tax under this Act' referred in section 76 appears to be output tax, based on this definition. Accordingly, any person collecting output tax will be liable to deposit it to the Government. Collecting output tax (or tax under this Act) higher than the prescribed, such person will be liable to deposit the entire amount collected with the Government. However, in case outward supplies are exempted (goods are exempted or recipient is given some exemption), supplier is free to collect 'input tax credit reversed' on account of this exemption on the outward supply. Such amounts collected NOT being in the nature of 'tax under this Act' or 'output tax', do not appear to be affected by section 76. Unison Metals Ltd. v. CCE-Ahd-I (2006) 204 ELT 323 (LB-Tri.) which considered similar provision of section 11D under Central Excise Act.

(83) "outward supply" in relation to a taxable person, means supply of goods or services or both, whether by sale, transfer, barter, exchange, licence, rental, lease or disposal or any other mode, made or agreed to be made by such person in the course or furtherance of business;

For any transaction or activity to qualify as an outward supply, it must first be a 'supply' in terms of the GST law, unlike inward supplies, which could merely be receipts, not amounting to supply. Further, an outward supply is closely associated with a 'taxable person' being, a unit of a person that has, or is required to have, a separate registration.

The phrase 'outward supply' can be applied to a supply only when such supply is made in the course or furtherance of business. Say, for instance, business assets are put to personal use. In such a case, even if the transaction is deemed to be a supply (made without consideration), it cannot be treated as an 'outward supply', since the application of the business asset for personal use was neither in the course nor furtherance of business.

The following aspects need to be noted:

- Supplies not qualifying as outward supplies would also be included for the purpose of computing the 'aggregate turnover';
- In case of a composition supplier, where he engages with a recipient outside the State,

and if the transaction does not result in an 'outward supply', (say, sending goods for job work outside the State), the conditions imposed on him as a composition supplier would not be violated (i.e., making inter-State outward supplies);

- Details of supplies on which tax is payable, but which do not amount to 'outward supplies' would also have to be declared in the return for outward supplies (GSTR-1);
- By treating goods or services "agreed" to be supplied as 'outward supply', the law authorises imposition of GST on advance payments;
- Reimbursement against goods or services purchased by employees of a taxable person would not be in furtherance of business of such employees to attract any tax.

<p>(84) "person" includes—</p> <p>(a) an individual;</p> <p>(b) a Hindu Undivided Family;</p> <p>(c) a company;</p> <p>(d) a firm;</p> <p>(e) a Limited Liability Partnership;</p> <p>(f) an association of persons or a body of individuals, whether incorporated or not, in India or outside India;</p> <p>(g) any corporation established by or under any Central Act, State Act or Provincial Act or a Government company as defined in clause (45) of section 2 of the Companies Act, 2013;</p> <p>(h) any body corporate incorporated by or under the laws of a country outside India;</p> <p>(i) a co-operative society registered under any law relating to co-operative societies;</p> <p>(j) a local authority;</p> <p>(k) Central Government or a State Government;</p> <p>(l) society as defined under the Societies Registration Act, 1860;</p> <p>(m) trust; and</p> <p>(n) every artificial juridical person, not falling within any of the above;</p>

This definition is to be read along with the fiction in Section 2(107) where a 'taxable person' is understood to be sub-units of a person such that transactions between two taxable persons is also a taxable supply. Every 'person' is understood to have a separate identity, under the GST law.

For instance, a trust set up by a company will be treated as a separate person from the

company, or a limited liability partnership holding all the shares of a company will be treated as a separate person from the company.

It is common to see entities who contribute assets and have a basket of different interests which are in the nature of partnerships. The sharing of risks could indicate such associates or joint venture. On the other hand one sided contract of revenue sharing maybe considered different. Please note that it has been held in the case of CIT v. RM Chidambaram Pillai (1977) 106 ITR 292 (SC) that 'firm' is a collective noun of the partners and not a legal person. Therefore, a contract with a firm is legally, multiple-simultaneous-identical contracts with each partner. Again in CIT, Bihar v. Ramniklal Kothari (1969) 74 ITR 57 (SC), it has been held that business of the firm is the business of the partner. Therefore, from GST perspective, there is no supply between the partners and their firm or vice versa and the flow of remuneration (in all the various forms that is permitted by Income-tax law) would not be taxable in the absence of any supply *inter se*.

(85) "place of business" includes—

- (a) a place from where the business is ordinarily carried on, and includes a warehouse, a godown or any other place where a taxable person stores his goods, supplies or receives goods or services or both; or
- (b) a place where a taxable person maintains his books of account; or
- (c) a place where a taxable person is engaged in business through an agent, by whatever name called;

The inclusive nature of the definition indicates that the places or locations listed in the definition are illustrative and not exhaustive. From the three clauses of such illustrative locations, each clause makes a reference to 'taxable person'. Therefore, place of business should be understood as a term that is specific to each taxable person, having (or requiring) distinct registrations. Say, in the case of a company having operations across 10 cities in two States, the set of cities being the places of business for one State would be mutually exclusive from that of the other.

Place of business therefore is not only any place where business is ordinarily carried on but it would also be a place where goods are located and kept ready for supply. Ex-works supplies, to a registered person from another State, without the goods immediately being transported out to that State, would also come within the definition of place of business. Therefore, there is no need to be concerned that location of supplier of goods is not defined in the law because unlike services, there is sufficient trail available in transactions involving supply of goods.

Below are other implications in relation to place of business:

- Registration of such places as additional place of business – although there is no explicit requirement under law to declare all places of business as additional places of business. This would facilitate transportation of goods between places of business, or from the job worker's premises to any of the places of business, which can be

supported with the delivery challan, the details of which would form part of Form Waybill;

- Maintenance of separate accounts in relation to each place of business such as details of production or manufacture of goods, inward and outward supply, stock records of goods, input tax credit availed, output tax payable and paid;
- Departmental audit can be carried out in respect of registered persons at any of its places of business; this apart, authorised officers can demand access to any such places to inspect books, documents, computers, etc.;
- Place of Business is not the same as Place of Supply. And registration is required at the POB and not at POS. Eg. Renting service is business which is 'ordinarily carried out' from the POB of the Landlord and not from the POS where the Property is situated. Installation activity is carried out at the project site which is not POB of the Supplier and the site may or may not be its POS. Construction activity carried out at the site could be the LOS (location of supplier of service) because it satisfies the definition of FE (fixed establishment) but both these would not POB of the contractor.

(86) "place of supply" means the place of supply as referred to in Chapter V of the Integrated Goods and Services Tax Act;

Chapter V of the IGST Act provides for determination of the 'place of supply' in respect of any supply of goods or supply of services. This expression has the utmost significance in determining the nature of tax payable on a supply. Simply put, a supply shall be intra-State (liable to CGST, SGST) where the location of the supplier and place of supply as determined under the said Chapter are in the same State (or Union Territory), and neither the supplier nor the recipient are SEZ units/ developers. In any other case, the supply would be treated as an inter-State supply, liable to IGST.

There is no provision in the law that declares that GST is a 'destination based tax'. Place of supply is therefore the destination of supply attracting tax under this law. Place of supply is not left out as a question of fact that each supplier has to determine but is a question of law that is left to only be discovered by an application of the law.

Chapter V deals with determination of 'place of supply' under the following brackets:

- (a) Goods, other than supply of goods imported into, or exported from India.
- (b) Goods imported into, or exported from India.
- (c) Services where location of supplier and recipient is in India.
- (d) Services where location of supplier or location of recipient is outside India.
- (e) Online information and database access or retrieval services (OIADARS) provided by a person located in a non-taxable territory to a non-taxable online recipient (i.e., Government, governmental or local authorities, individuals, other persons receiving such services for purpose other than commerce, industry, business, profession, but

located in taxable territory).

(87) “prescribed” means prescribed by rules made under this Act on the recommendations of the Council;

The law empowers the Government to issue rules to facilitate the implementation of the provisions of the Act, or to carry out the objects of the law. Whenever the term ‘prescribed’ is used in the Act, one must draw reference to the relevant rules that may be issued in respect thereof.

(88) “principal” means a person on whose behalf an agent carries on the business of supply or receipt of goods or services or both;

The law uses the term ‘principal’ in the context of two relationships – one in case of the principal and job worker, and the other in case of principal and agent. However, in the provisions relating to job work, the term has a separate meaning, the reference of which is separately provided for. Therefore, one must understand the meaning of the term ‘principal’ wherever else the term finds a mention, as a reference to the principal-agent relationship.

Agent of the principal is one who carries on the business of supply or receipt of goods or services or both on behalf of another person, being the principal. The agent functions as an extended arm of the principal and therefore, supplies (inward and outward) effected by an agent on behalf of the principal will be treated as supplies effected by the principal. Reference may be had to circular 57/31/2018-GST where illustrations have been provided as to when a supply via agent would be a supply by agent and when it would remain a supply by principal.

(89) “principal place of business” means the place of business specified as the principal place of business in the certificate of registration;

The principal place of business could be any of the places of business of a person, which is located in the same State in which the registration is intended to be obtained. Generally, this location would be the head office or the corporate office or the billing address of the person, or the address registered under a statute such as the Companies Act, or as specified in the partnership deed. Once a location is chosen, it would be used for correspondence by the GST officers, and should therefore be mentioned on the certificate of registration. For multi locational tax payers they would have 1 principal place per State.

The law requires that the books of account shall be maintained at the principal place of business, or may be maintained electronically, on fulfilling the conditions prescribed by the rules.

(90) “principal supply” means the supply of goods or services which constitutes the predominant element of a composite supply and to which any other supply forming part of that composite supply is ancillary;

The concept of ‘a principal supply’ emerges only for determining whether a supply is a

composite supply or not, and where it is a composite supply, the rate of tax applicable to the composite supply.

Principal supply recognises two or more supplies, and arranges them in a two-step hierarchy – a single predominant supply and the ancillary supply(ies).

- (a) Supply of laptop and a carry case – In this case, the case only adds value to the supply of laptop and therefore, the case would be ancillary while the laptop comprises the predominant element of the supply. Even where the brand of the case is not the same as that of the laptop, and the supplier can establish that the case is naturally bundled with the laptop in the ordinary course of his business, the supply can be treated as a composite supply.
- (b) Supply of equipment and installation/ commissioning of the same – While the recipient actually purchases the equipment, making the equipment the principal supply, the installation makes the equipment usable by the recipient. Even if there is a separate charge for the installation of the equipment, since the service is naturally bundled and provided in the ordinary course of business, the supply would be a composite supply.
- (c) Supply of repair services of laptop with parts – As such, it is the skill and expertise of the supplier that makes the laptop function as desired. Whether replacement is necessary or a mere resetting of the existing parts restores the functionality of the laptop is not known to the customer. Where the object of the contract is unknown to the customer, that object cannot be the purpose of the contract. The only object that is known to the customer is the 'repair service' which makes it the predominant object of supply. This would be the position even if the cost of the parts replaced is higher than the cost of service. *However, this theory can apply only where such a replacement is done in the ordinary course of the business of repairing laptops, and such a replacement is naturally bundled with the repair service.*

(91) *“proper officer” in relation to any function to be performed under this Act, means the Commissioner or the officer of the central tax who is assigned that function by the Commissioner in the Board;*

The Government would appoint persons to act as officers of specified classes. However, all such officers would not be 'proper officers' under the GST law. It may be understood that the term 'proper officer' is to a case or a category of cases. Therefore, a Commissioner having jurisdiction in respect of a taxable person, may authorise certain officers of the GST law to act as proper officer in respect of such taxable person.

Further, the officers appointed under the SGST and UTGST laws are authorised to be the proper officers for the purposes of the CGST law.

(92) *“quarter” shall mean a period comprising three consecutive calendar months, ending on the last day of March, June, September and December of a calendar year;*

In terms of the definition provided above, we can understand that the following would be the

four quarters for the purposes of GST:

- (a) January, February and March;
- (b) April, May and June;
- (c) July, August and September; and
- (d) October, November and December.

For any reason, whatsoever, the term 'quarter' cannot be associated with three consecutive months other than those mentioned above. For instance, a composition supplier is required to furnish returns on a quarterly basis – this does not entitle him to furnish a return for the periods June, July and August, even if he obtained registration only on 29th June.

(93) "recipient" of supply of goods or services or both, means—

- (a) where a consideration is payable for the supply of goods or services or both, the person who is liable to pay that consideration;
- (b) where no consideration is payable for the supply of goods, the person to whom the goods are delivered or made available, or to whom possession or use of the goods is given or made available; and
- (c) where no consideration is payable for the supply of a service, the person to whom the service is rendered,

and any reference to a person to whom a supply is made shall be construed as a reference to the recipient of the supply and shall include an agent acting as such on behalf of the recipient in relation to the goods or services or both supplied;

In transactions involving more than 2 persons, it could result in an ambiguity as to who should be treated as the 'recipient' for filing the return of inward supplies, paying tax on reverse charge basis, determining whether the relationship with the supplier will impact valuation, etc. In this regard, the definition specified the following:

- Where consideration payable: The recipient of supply and place of supply do not affect one another where a consideration is payable for the supply. Irrespective of the place of supply, the person who is liable for payment of consideration would be the recipient. This would hold good even in the case where the supply is made to person on the instruction of another – i.e., even if the goods are received by a person, if the person on whose instruction the goods are delivered is the person liable to pay consideration, such person giving the instruction would be the recipient.
- Where no consideration payable:
 - Goods: The actual receiver of the goods would be the recipient. Say, for instance, a supplier keeps a counter in the premises of another company for issuing free samples to the employees of the company. The recipients would be the employees, and not the company permitting the use of its premises.
 - Services: The actual receiver of the services would be the recipient.

- The definition of 'consideration' in Section 2(31) clearly provides that the consideration can be from the recipient or by any other person. However, the law provides that the person paying the consideration shall be treated as the 'recipient'. It appears that the term 'recipient' referred to in Section 2(31) should be read as 'receiver of the supply', and not 'recipient' as defined above.
- In case an agent is appointed by the principal, such agent may also be treated as the recipient of the goods or services or both.

(94) "registered person" means a person who is registered under section 25 but does not include a person having a Unique Identity Number;

The law makes several references to this term. The most significant implication of this reference is that it is confined to a registration of a person, who may have (or is required to have) more than one registration.

Every person/ unit of a person requiring registration, i.e., every taxable person, will be treated as a registered person the moment registration is granted to it, excluding cases where a Unique Identity Number (UIN) is granted.

A specialised agency of the United Nations Organisation or any Multilateral Financial Institution and Organisation notified under the United Nations (Privileges and Immunities) Act, 1947, Consulate or Embassy of foreign countries and any other persons who are notified by the Commissioner shall be granted a UIN for certain purposes – such as for refund of taxes on the notified supplies of goods or services or both received by them.

(95) "regulations" means the regulations made by the Board under this Act on the recommendations of the Council;

The Central Board of Indirect Tax and Customs* constituted under the Central Boards of Revenue Act, 1963 (Board) is empowered to make regulations consistent with the Act and the rules made under the Act, to carry out the provisions of the Act.

Every regulation made by the Board under the Act would be laid after it is made or issued, before each House of Parliament, while it is in session, at the earliest. Where both Houses agree in making any modification, or that the regulation should not be made, the regulation shall have effect only in such modified form or be of no effect from such date (i.e., no retrospective effect of the modifications/ rejection by the Houses of the Parliament).

(96) "removal" in relation to goods, means—

- despatch of the goods for delivery by the supplier thereof or by any other person acting on behalf of such supplier; or*
- collection of the goods by the recipient thereof or by any other person acting on behalf of such recipient;*

The term "removal" is relevant in the case of supply of goods. Under the Central Excise Rules, 2002, the term 'removal' also included the act of issue of the goods for captive consumption.

However, under the GST law, there must be a supplier, and a recipient who is distinct person. Therefore, removal of goods used within the factory would not constitute an outward supply (while input tax credit restriction implications could arise).

Under the GST law, the significance of this term arises for raising invoice, which in turn, is an element essential to determine the time of supply. The law clearly specifies that the removal need not be effected by the supplier himself, but could also be a result of collection of the goods by the recipient or a person acting on his behalf job worker, agent. Further, this term would be relevant only to the extent of supplies requiring movement of goods.

Please take note that in GST 'removal', 'movement' and 'delivery' have been used and each have their independent meanings and are not to be understood to be synonyms. General understanding of these terms and their differences are that Removal is handing over or collecting of goods to be taken away or carried away, by supplier or recipient, even without commencement of actual transportation of the goods to the destination. Movement is the physical transportation by the person taking the responsibility of transportation which may be supplier, recipient or other carrier. Delivery is a legal concept of completion of appropriation in favour of recipient so as to complete supplier's obligations in respect of the supply. Removal is a decisive first step towards commencement of supply. Delivery is the decisive last step towards completion of supply. Movement is all the observable activity occurring in between.

(97) "return" means any return prescribed or otherwise required to be furnished by or under this Act or the rules made thereunder;

The term 'return' is used in this law, as under other taxation laws, to refer to a document by which details of transactions are furnished to the relevant tax department. This term is also used under the GST law, to refer to returning-back goods after they have been delivered to customers (commonly known as purchase returns, sale returns). However, term does not refer to any 'one' specific document that is filed. It includes 'any' document titled 'return' which may be prescribed or required to be furnished by CGST Act or CGST Rules. Reference may be had to section 61 and 62 to understand which 'returns' attract those provisions and then compare with what may be understood as 'return' in each context.

(98) "reverse charge" means the liability to pay tax by the recipient of supply of goods or services or both instead of the supplier of such goods or services or both under sub-section (3) or sub-section (4) of section 9, or under sub-section (3) or sub-section (4) of section 5 of the Integrated Goods and Services Tax Act;

The scheme of payment of tax under reverse charge mechanism would prevail under the GST Law, as is existent in specific cases of services, and in case purchases from unregistered dealers under the VAT law. However, in the GST law, the scope of reverse charge is expanded to include:

- (a) Goods (in addition to services) that may be notified, even if the supplier is registered;
- (b) Services (in addition to goods), for taxation on reverse charge basis where the supplier

is unregistered and supplied to specified classes of recipients who are registered.

The following aspects need to be noted:

- The scheme of partial reverse charge of joint charge, previously prevailing under the Service tax laws does not continue in GST;
- Persons required to pay tax under reverse charge are required to obtain registration under the GST whether or not they make any outward supplies, and without having regard to the threshold limits for registration – in case of notified goods and services;
- Composition suppliers being recipients of supplies on which tax is payable on reverse charge basis, will have to remit tax at the applicable rates, and not the concessional composition tax rates;
- The recipient paying tax on reverse charge basis, should issue a 'payment voucher' at the time of making payment to the supplier;
- The recipient paying tax on reverse charge basis on account of effecting inward supplies from unregistered persons, should issue an invoice in respect of the goods or services inwarded, at the time of receipt of such goods or services.

(99) "Revisional Authority" means an authority appointed or authorised for revision of decision or orders as referred to in section 108;

The Revisional Authority is empowered to pass an order to enhance or modify or annul a decision/ order under CGST/ SGST/ UTGST Acts as is passed by an officer sub-ordinate to him, where he finds it to be prejudicial to the interest of revenue if it is erroneous, illegal, improper or has not considered material facts (whether or not available at the time of the original decision/ order). However, such powers are not available to him in case of non-appealable orders. Refer to section 108 and the discussion ensuing to understand the overstretched authority of an administrative authority being permitted to interfere with an order of the First Appellate Authority which is, for all practical purposes, a judicial function being discharged.

(100) "Schedule" means a Schedule appended to this Act;

The following three schedules are provided under the CGST Act to describe the extent/ limitation of the meaning of the term 'supply':

- (a) **Schedule I:** Activities to be treated as supply even if made without consideration
- Permanent transfer or disposal of business on which input tax credit is availed. Please note that the condition of 'on which input tax credit is availed' whether it applies only to disposal of business assets or also to the previous expression of permanent transfer is interesting to analyse due to the disjunctive 'or' present separating to the two transaction. Also, when credit is reversed on business assets disposed (under section 17(5)(h)) then those transactions of disposal of business assets will not come within the fiction of sch I. But, permanent transfer (not being the same as disposal) of anything

attracts the fiction of sch I.

- supplies between related persons or persons having the same PAN. Please note that the transaction must be a supply except for the their relationship requiring a re-examination (between related persons) or when transaction is missing an ingredient of two-persons to the transaction (distinct persons by fiction in section 25)
 - supply of goods by a principal to his agent and vice versa. Please note that the transaction must already be a 'supply' and sch I only furnishes a remarkably different treatment by this fiction.
 - import of services for business purpose, by a taxable person from a related person.
- (b) **Schedule II:** Activities or Transactions (as per CGST Amendment Act) to be treated as supply of goods or supply of services

1. Transfer

- (a) *any transfer of the title in goods is a supply of goods.* Please refer to the difference between 'transfer' and 'sale' in the discussion under section 7 and recognize that all cases where title 'gets' transferred, it is required to be treated by the fiction in sch II as a supply of goods and not as services. Please also note that transfer is not the same as extinguishment or consumption. Extinguished is when goods are consumed in the course of performance of a contract and this, not being transfer, may be open to treatment as supply of services. For eg. Job-work involving consumption of catalyst or welding rods, etc;
- (b) *any transfer of right in goods or of undivided share in goods without the transfer of title thereof, is a supply of services.* Although goods are involved in such a transaction and their movement requires use of e-way bill, transaction will continue to be treated as supply of services and not as supply of goods;
- (c) *any transfer of title in goods under an agreement which stipulates that property in goods shall pass at a future date upon payment of full consideration as agreed, is a supply of goods.* Here, title may pass after all instalments are paid like hire purchase, but the treatment required due to sch II is that it will be supply of goods and not services. Please differentiate 1(b) and 1(c). There is enough guidance in ICAI material on AS/IndAS to make this differentiation by examining the contract terms of each of these arrangements.

2. Land and Building

- (a) *any lease, tenancy, easement, licence to occupy land is a supply of services.* Please note that these four expressions are not synonyms but need careful study based on the definition and authorities under Transfer of Property Act, Easement Act and Limitation Act which are all laws enacted in 1882 and Indian Contract Act which was enacted in 1972. So there is much to be discussed but better

understood by reference to any good material under each of these laws to be able to correctly identify the nature of the transaction for GST purposes. For eg. If a CA owned rubber trees and gave a contract for extraction of latex, would it be a contract for services of extraction benefits arising from land or contract for sale of goods (latex);

- (b) *any lease or letting out of the building including a commercial, industrial or residential complex for business or commerce, either wholly or partly, is a supply of services.* Use of words like 'letting out' requires identification of the presence of underlying arrangement

3. *Treatment or process*

Any treatment or process which is applied to another person's goods is a supply of services. Please note that reference to expression 'treatment or process' is deliberate use of words and covers larger area than 'manufacture'. In other words, even if the said treatment or process does not amount to manufacture, that is, emergence of a new and distinct commodity, it would remain an activity that will be treated as supply of services. And this would apply even when the person carrying out the treatment or process adds or incorporates goods of his own to the output brought out from the treatment or process.

4. *Transfer of business assets*

- (a) *where goods forming part of the assets of a business are transferred or disposed of by or under the directions of the person carrying on the business so as no longer to form part of those assets, whether or not for a consideration, such transfer or disposal is a supply of goods by the person.* This clause deals with assets that exit the business without being retained for continued use in any transferred business will be treated as a supply of goods. Assets that remain and be used in the continued business appear, by implication, to be not liable to tax. And when there is mere disuse of assets that are transferred or disposed will be taxable even in the absence of any transfer-of-business event;
- (b) *where, by or under the direction of a person carrying on a business, goods held or used for the purposes of the business are put to any private use or are used, or made available to any person for use, for any purpose other than a purpose of the business, whether or not for a consideration, the usage or making available of such goods is a supply of services.* This treatment may please be examined in along with paragraph 1 of sch I. Special care is needed when there is 'change of use' of assets that were once entered into business at the time of their receipt;
- (c) *where any person ceases to be a taxable person, any goods forming part of the assets of any business carried on by him shall be deemed to be supplied by him in the course or furtherance of his business immediately before he ceases to be a*

taxable person, unless— (i) the business is transferred as a going concern to another person; or (ii) the business is carried on by a personal representative who is deemed to be a taxable person. Please note that this clause does not provide the ‘treatment’ (as supply of goods or supply of services) but merely declares that deregistration will occasion a supply by fiction in sch II. Also, reference may be had to sections 2(17)(d), 18(6) and 25(5) of CGST Act. Please also note that ‘assets of a business’ must be understood not merely as capital goods or inputs in stock but all assets in the business – tangible and intangible – that will be treated as supply of goods in all these cases when the transfer occurs in any arrangement for ‘transfer of business’. Transfer of business is evidenced not by itemized sale but sale as going concern. It is to be recognized that transfer of business may be by way of demerger, slump sale or other recognized modes under other substantive laws including.

5. Supply of services

- (a) *renting of immovable property.* Please note that ‘renting’ is an expression that is popular but not explicit either as lease or license as understood under Transfer of Property Act. Care is needed to identify the nature of arrangements involving immovable property. Also please note that immovable property includes land, building and intangible interests in such land or building as well as benefits arising from land and building;
- (b) *construction of a complex, building, civil structure or a part thereof, including a complex or building intended for sale to a buyer, wholly or partly, except where the entire consideration has been received after issuance of completion certificate, where required, by the competent authority or after its first occupation, whichever is earlier.* Please note that this clause is explicit, even if overlapping with other paras in this sch II. But the remarkable aspect here is that incomplete building is expressly taxable even though Courts have held that construction for self ought not to be taxed in the absence of a contract to sell (or supply in GST);
- (c) *temporary transfer or permitting the use or enjoyment of any intellectual property right.* It may be noted that permanent transfers are excluded as IP are also goods. IP may form part of an overall arrangement and suitable treatment may be given in such comprehensive arrangements based on the principle of composite or mixed supply;
- (d) *development, design, programming, customisation, adaptation, upgradation, enhancement, implementation of information technology software.* Software is goods (4907 or 8523) but where supply involves software services that are not goods (like shrink wrapped software), only those transactions are treated as supply of services;

- (e) *agreeing to the obligation to refrain from an act, or to tolerate an act or a situation, or to do an act.* Please note that supply is not only a 'positive' transaction but also 'negative' transaction or 'inaction'. For this reason, CGST Amendment Act has even edited the title of sch II; and
- (f) *transfer of the right to use any goods for any purpose (whether or not for a specified period) for cash, deferred payment or other valuable consideration.* Refer also para 1(b) to identify consistency in treatment whether goods are leased or licensed.

6. Composite supply

- (a) works contract as defined in clause (119) of section 2; and
- (b) *supply, by way of or as part of any service or in any other manner whatsoever, of goods, being food or any other article for human consumption or any drink (other than alcoholic liquor for human consumption), where such supply or service is for cash, deferred payment or other valuable consideration.* Please note that this fiction requires goods in packed condition when including in the supply as described in this para will continue to be treated as supply of services. As service is not a verb but a noun, once the supply comes within the mischief of this para, then it will always be treated as a supply of services. There is no occasion to search for goods within this supply and vivisect them contrary to the fiction in this para.

7. Supply of Goods

Supply of goods by any unincorporated association or body of persons to a member thereof for cash, deferred payment or other valuable consideration. Please note that supply of goods 'to' members will be treated as supply of goods. Reference may be had to the section 2(17)(e) above.

- (c) **Schedule III:** Activities or transactions which shall be treated neither as a supply of goods nor a supply of services

Services by employee to employer in the course/ relation to employment, Services of funeral, burial, crematorium or mortuary, sale of land, sale of completed buildings, actionable claims (other than lottery, betting and gambling), services by any court or Tribunal, the functions performed by the Members of Parliament, etc., supply of goods without entering India or without crossing customs boundaries of India "Supply of warehoused goods to any person before clearance for home consumption; Supply of goods by the consignee to any other person, by endorsement of documents of title to the goods, after the goods have been dispatched from the port of origin located outside India but before clearance for home consumption"

(101) "securities" shall have the same meaning as assigned to it in clause (h) of section 2 of the Securities Contracts (Regulation) Act, 1956;

Section 2(h) of the Securities Contracts (Regulation) Act, 1956 provides an inclusive definition to the term "securities", listing the following—

- (i) *shares, scrips, stocks, bonds, debentures, debenture stock or other marketable securities of a like nature in or of any incorporated company or other body corporate;*
 - (ia) *derivative;*
 - (ib) *units or any other instrument issued by any collective investment scheme to the investors in such schemes;*
 - (ic) *security receipt as defined in clause (zg) of section 2 of the Securitisation and Reconstruction of Financial Assets and Enforcement of Security Interest Act, 2002;*
 - (id) *units or any other such instrument issued to the investors under any mutual fund scheme;*
- (ii) *Government securities;*
 - (iia) *such other instruments as may be declared by the Central Government to be securities; and*
 - (iib) *rights or interest in securities.*

Securities has a very expansive definition and must be differentiated from financial contractual arrangement. Please consider examples of commodity futures, interest swaps, etc. Securities are neither treated as goods nor as services, by way of a specific exclusion in the respective definitions. For this reason, 'securities' would not be included in the meaning of 'non-taxable supplies' which are in turn included within the meaning of 'exempt supplies'. Therefore, for the limited purpose of restricting input tax credits, the meaning of exempt supplies would include 'securities', and therefore, input tax credit attributable to transactions in securities would be liable for reversal.

(102) "services" means anything other than goods, money and securities but includes activities relating to the use of money or its conversion by cash or by any other mode, from one form, currency or denomination, to another form, currency or denomination for which a separate consideration is charged;

Explanation.–For the removal of doubts, it is hereby clarified that the expression "services" includes facilitating or arranging transactions in securities⁷

Express exclusion of goods implies its inclusion within the definition of services. Therefore, understanding the exact scope and boundaries of the definition of goods is required to recognize all those transactions or activities that would fall under the meaning of 'services', on being left out of the definition of 'goods'. Transactions in money (other than its conversion) are excluded both from the definition of goods and from the definition of services. 'Anything' includes everything and leaves nothing – services includes goods and for this reason 'other than goods' appears in the definition. But for such exclusion it would have been included. And services includes immovable property as well. Transactions involving immovable property to

⁷ Inserted vide The Central Goods and Services Tax Amendment Act, 2018 w.e.f. 01.02.2019

the extent excluded by paragraph 5, schedule III only. All other transactions involving immovable property comes squarely within the scope of expression 'services'.

Services is therefore not a verb but a noun. As such, there is no need to search for the activity performed in a transaction involving services but sufficient to note that it is not goods then it will be services. If this manner of drafting the definition that allows tax to be imposed on transactions of tolerating an act or abstaining from an act as found in paragraph 5(e), schedule II.

The following aspects need to be noted:

- The word "anything" appears to convey something very vast like "everything", i.e., services means everything that is not goods, and is not specifically excluded (such as money, securities, transactions specified in Schedule III, etc.)
- Schedule II of the CGST Act lists down matters which shall be regarded as a supply of goods, or supply of services.
- The GST law empowers the Government to require treatment of supply of notified goods as supply of services, and *vice versa*.

(103) "State" includes a Union territory with Legislature;

Each State derives its respective meaning provided in the First Schedule in the Constitution of India. There are 29 States and 7 Union Territories in India. Of the 7 Union Territories, Delhi and Puducherry have Legislatures of their own. Therefore, for the GST law, by the expression 'State', Delhi and Puducherry, though Union Territories, will be included.

The Legislative Assemblies of Delhi and Puducherry would pass State GST Acts for intra-State levies, while the remaining 5 Union Territories will be governed commonly under the UTGST Act.

(104) "State tax" means the tax levied under any State Goods and Services Tax Act;

Tax levied under the State GST laws is referred to as "State tax". State tax is that component of GST that levied on intra-State supplies by the State Governments (of the Legislatures of Delhi and Puducherry), under the respective State-specific GST laws.

(105) "supplier" in relation to any goods or services or both, shall mean the person supplying the said goods or services or both and shall include an agent acting as such on behalf of such supplier in relation to the goods or services or both supplied;

The reference to whom the meaning of the term 'supplier' is fitted is 'person', as against 'taxable person' or 'registered person'. This is because the law does not keep persons who are not liable to tax under GST, outside the scope of this term. For instance, in case of purchases from unregistered persons, who are not liable for registration, would also be treated as suppliers, while the recipient of the supply is liable to pay tax on reverse charge basis if such recipient is registered.

Agents supplying on behalf of the supplier are also included within the meaning of 'supplier'. This is to ensure that invoices raised by the agent on behalf of the supplier for effecting sales on his behalf qualify as valid invoices, as if they were issued by the supplier himself.

(106) "tax period" means the period for which the return is required to be furnished;

Given that the term 'return' is not limited to any particular return, the term tax period can also vary for each return prescribed under the law. A 'tax period' would ordinarily be the calendar months (or quarters ending on the last dates of March, June, September and December in case of composition suppliers). However, it can also include a period of one financial year, for the annual return.

(107) "taxable person" means a person who is registered or liable to be registered under section 22 or section 24;

Every 'supplier' shall be liable to be registered under the GST law in the State (or Union territory) from where he makes any taxable supply of goods or services or both, if his aggregate turnover in a financial year exceeds the specified limit (Rs. 20 Lacs or Rs. 10 Lacs – refer Section 22 for details).

The following persons (amongst others) are also compulsorily required to obtain registration, whether or not their turnover exceeds the threshold limit:

- Non-resident taxable persons, casual taxable persons making any taxable supply
- Persons making any inter-State taxable supply;
- Recipients of supplies of goods or services that are notified for tax on reverse charge basis;
- Persons such as agents who make taxable supplies on behalf of other taxable persons;
- Electronic commerce operator and persons effecting supplies through them;
- Person supplying OIADAR services from a place outside India to an unregistered person in India.

(108) "taxable supply" means a supply of goods or services or both which is leviable to tax under this Act;

For a transaction to qualify as a taxable supply, the following components are compulsory:

- The transaction must involve either goods or services, or both of them;
- Such goods or services should not be specified under Schedule III (neither a supply of goods nor a supply of services);
- The transaction should fall within the meaning of 'supply' in terms of Section 7 of the CGST Act;
- The supply should be leviable to GST – i.e., it should not be covered within the meaning of 'non-taxable supply' as defined under Section 2(78) – i.e., alcoholic liquor for human

consumption. This implies that supplies enjoying a full exemption from tax by way of an exemption notification would also be treated as taxable supplies.

Please note the expression 'taxable supply' must be distinguished from 'taxable goods or services'. Please see its usage in section 51 versus section 52. When expression used is 'taxable supply', then even when exempt, it would come within the said definition. But not so, when the expression used is 'taxable goods or services'. Care must be taken not to view these seemingly similar expressions as synonymous.

(109) "taxable territory" means the territory to which the provisions of this Act apply;

The scope of taxable territory extends to the whole of India. As such, high sea sales and merchanting trade transactions (eg. buy from China and directly ship to Germany) are transactions of a certain 'taxable person' but occurring outside taxable territory. As the words of section 7(5)(a) are 'supplier located in India' and not 'location of supplier is in India', such transactions occurring beyond the taxable territory of India would also be inter-State supplies but non-taxable as the levy is not attracted. Any taxable person would fit the expression 'supplier located in India' meaning the 'person who supplies' and not the Consignor (in China). Care may be taken to note this subtle difference in the words in section 7 of IGST Act

(110) "telecommunication service" means service of any description (including electronic mail, voice mail, data services, audio text services, video text services, radio paging and cellular mobile telephone services) which is made available to users by means of any transmission or reception of signs, signals, writing, images and sounds or intelligence of any nature, by wire, radio, visual or other electromagnetic means;

The scope of the term 'telecommunication service' is so vast that it covers services starting from the landline facility for making calls, text messages, voice messages, communication through media such as WhatsApp, Skype, etc., to services provided by Gmail, yahoo, etc.

(111) "the State Goods and Services Tax Act" means the respective State Goods and Services Tax Act, 2017;

The SGST Act means that SGST Act of the relevant State (or Delhi or Puducherry), as the case may be, which provides for levy and collection of tax on all intra-State supplies of goods or services or both (except alcoholic liquor for human consumption), i.e., the supply of goods or services or both where the location of the supplier and the place of supply as determined under Chapter V of the IGST Act are located within the same State. Upon passing of the GST law in each of the "States", there would be 31 SGST Acts in India.

(112) "turnover in State" or "turnover in Union territory" means the aggregate value of all taxable supplies (excluding the value of inward supplies on which tax is payable by a person on reverse charge basis) and exempt supplies made within a State or Union territory by a taxable person, exports of goods or services or both and inter-State supplies of goods or services or both made from the State or Union territory by the said taxable person but excludes central tax, State tax, Union territory tax, integrated tax and cess;

The expression 'turnover in State' (or UT,) is a replica of the expression 'aggregate turnover', but for the fact that 'turnover in State' is restricted to the turnover of a taxable person, as opposed to aggregate turnover which is PAN-based (i.e., all taxable persons having the same PAN, across States). The following references are made in to the phrase in the Act:

- Payment of tax under composition scheme: The tax rate will be applicable on the 'turnover in State' particular to a taxable person, which should be paid by him in the State in which he has obtained registration;
- Distribution of input tax credit by an ISD: In case of the distribution of credit that is attributable to two or more units of the person, the credit shall be distributed amongst such units on a pro rata basis (i.e., ratio of their respective 'turnover in State' to the aggregate of the 'turnover in State' of all such units).

(113) "usual place of residence" means—

- (a) in case of an individual, the place where he ordinarily resides;
- (b) in other cases, the place where the person is incorporated or otherwise legally constituted;

The expression 'usual place of residence' comes of use to determine the location of supplier/ recipient of services where no other location is relatable to the supply/ receipt of service.

(114) "Union territory" means the territory of—

- (a) the Andaman and Nicobar Islands;
- (b) Lakshadweep;
- (c) Dadra and Nagar Haveli;
- (d) Daman and Diu;
- (e) Chandigarh; and
- (f) other territory.

Explanation. —For the purposes of this Act, each of the territories specified in sub-clauses (a) to (f) shall be considered to be a separate Union territory;

All the Union Territories and "other territory" (as defined in Section 2(81) supra) in India will be governed under the UTGST Act, except Delhi and Puducherry. Given that the said two UTs have a Legislature, they will be regarded as 'States' for the purpose of GST, and will be governed by their respective SGST laws, instead of the UTGST law.

(115) "Union territory tax" means the Union territory goods and services tax levied under the Union Territory Goods and Services Tax Act;

It refers to the tax charged under the UTGST Act on intra-State supply of goods or services or both (i.e., supplies effected within a Union Territory not having a Legislature), in addition to the

tax levied under the CGST law. The rate of UT tax is capped at 20%, and will be notified by the Central Government based on the recommendation of the Council.

(116) "Union Territory Goods and Services Tax Act" means the Union Territory Goods and Services Tax Act, 2017;

The UTGST Act provides for levy and collection of tax on all intra-State supplies of goods or services or both (except alcoholic liquor for human consumption), i.e., the supply of goods or services or both where the location of the supplier and the place of supply as determined under Chapter V of the IGST Act are located within the same UT.

(117) "valid return" means a return furnished under sub-section (1) of section 39 on which self-assessed tax has been paid in full;

The term 'valid return' is attributable only to the monthly return in Form GSTR-3, to be filed by every registered person (except a composition supplier, non-resident taxable person, ISD, person liable to deduct tax at source and person liable to collect tax at source). The return will be treated as a valid return only where the tax liability determined in the return is fully remitted.

The following aspects need to be noted:

- The law mandates that the liability determined in the returns of previous months must be discharged prior to discharging the liability determined in the returns of current month;
- Input tax credit will become available to the recipient only if the return furnished by the supplier is a 'valid return'.

(118) "voucher" means an instrument where there is an obligation to accept it as consideration or part consideration for a supply of goods or services or both and where the goods or services or both to be supplied or the identities of their potential suppliers are either indicated on the instrument itself or in related documentation, including the terms and conditions of use of such instrument;

'Voucher', for the purposes of GST, necessarily means that instrument which should be accepted as consideration (wholly or partly) for a supply. Therefore, a voucher is an asset for the recipient, and without a recipient, a 'voucher' would lose its meaning. Therefore, in a case of a supplier issuing a voucher to a recipient of goods, on his making a purchase from the supplier, the voucher is not being viewed as an additional outcome of the supply made to the recipient. Rather, it is an instrument that can be used in place of money (or other consideration) which can be used on effecting yet another inward supply. E.g. coupons, tokens, promo-codes, etc.

However, where the supply can be identifiable at the time of issue of voucher, the tax should be remitted for the month in which the voucher is issued, as if it were an advance received for a supply to be made at a future date.

Reference maybe had to the discussion in the context of money under section 2(75) about Payments and Settlement Systems Act, 2007 where RBI is authorized to issue pre-paid instruments (PPIs) apart from Indian legal tender to be used to settle obligations to pay consideration. All vouchers are not money if they are not so recognized by RBI. And if the vouchers are recognized by RBI then they will take the character of money. Reference may be had to the discussion in the context of time of supply under section 12(4)/13(4) for a detailed discussion on the types of vouchers and implications in GST.

(119) "works contract" means a contract for building, construction, fabrication, completion, erection, installation, fitting out, improvement, modification, repair, maintenance, renovation, alteration or commissioning of any immovable property wherein transfer of property in goods (whether as goods or in some other form) is involved in the execution of such contract;

The expression 'works contract' is limited to contracts to do with immoveable property, unlike the erstwhile understanding of the phrase which also extends to moveable property. A contract will amount to a 'works contract' only where the resultant which is immovable property. Transactions resulting in movable property, however, would be treated as a 'composite supply' of goods or services depending on the principal supply (refer analysis of Section 8).

The 14 adjectives used in the definition of works contract are neither exhaustive nor limiting the scope of works contract. Conspicuous by their absence are adjectives like manufacture, assembly, printing and so on. As stated earlier the presence of certain objectives of the absence of certain others limit the scope of what works contract is under GST. If the resultant is bringing into existence of immovable property, then the supply is a works contract. Obviously, pre-existing immovable property being involved in a transaction will be saved to the extent of paragraph 5, schedule III.

For GST law, works contract as defined above will be treated as a supply of service, thereby bringing debate to a close on the methodology of segregating the works contract between goods and services. Due to treatment as a supply of services, transactions such as sales returns, cancellation, non-approval of work done, carrying forward of work-in-progress, etc. are faced with restrictions in GST as no provision appears to be made to accommodate such transactions which are akin to goods even when works contracts are treated as supply of services.

(120) words and expressions used and not defined in this Act but defined in the Integrated Goods and Services Tax Act, the Union Territory Goods and Services Tax Act and the Goods and Services Tax (Compensation to States) Act shall have the same meaning as assigned to them in those Acts;

Certain words and expressions like exports, import, etc. defined in the IGST/ UTGST/ Compensation laws as are used under the CGST law will have the same meaning as assigned in such laws.

(121) any reference in this Act to a law which is not in force in the State of Jammu and Kashmir, shall, in relation to that State be construed as a reference to the corresponding law, if any, in force in that State.

From the extent-clause provided in Section 1 of the CGST Act, the CGST Act is now applicable in the State of Jammu and Kashmir. Wherever a reference to another law is drawn in the CGST Act, (say reference to the Service tax laws), for the State of Jammu and Kashmir, such a reference should be understood as a reference to the corresponding operational law in the State (i.e., the Jammu and Kashmir General Sales Tax Act, 1962).

Extract of the CGST Rules, 2017

2. Definitions

In these rules, unless the context otherwise requires,-

- (a) "Act" means the Central Goods and Services Tax Act, 2017 (12 of 2017);
- (b) "FORM" means a Form appended to these rules;
- (c) "Section" means a section of the Act;
- (d) "Special Economic Zone" shall have the same meaning as assigned to it in clause (za) of section 2 of the Special Economic Zones Act, 2005 (28 of 2005);
- (e) Words and expressions used herein but not defined and defined in the Act shall have the meanings respectively assigned to them in the Act.

Chapter 2

Administration

3. **Officers under this Act**
4. **Appointment of officers**
5. **Powers of officers**
6. **Authorisation of officers of State tax or Union territory tax as proper officer in certain circumstances**

Statutory Provision

3. Officers under this Act

The Government shall, by notification, appoint the following classes of officers for the purposes of this Act, namely: —

- (a) Principal Chief Commissioners of Central Tax or Principal Directors General of Central Tax,*
- (b) Chief Commissioners of Central Tax or Directors General of Central Tax,*
- (c) Principal Commissioners of Central Tax or Principal Additional Directors General of Central Tax,*
- (d) Commissioners of Central Tax or Additional Directors General of Central Tax,*
- (e) Additional Commissioners of Central Tax or Additional Directors of Central Tax,*
- (f) Joint Commissioners of Central Tax or Joint Directors of Central Tax,*
- (g) Deputy Commissioners of Central Tax or Deputy Directors of Central Tax,*
- (h) Assistant Commissioners of Central Tax or Assistant Directors of Central Tax, and*
- (i) any other class of officers as it may deem fit:*

Provided that the officers appointed under the Central Excise Act, 1944 shall be deemed to be the officers appointed under the provisions of this Act.

The Government vide Notification No.2/2017 – Central Tax dated 19.06.2017 has appointed the following classes of officers for the purposes of this Act: —

- (a) Principal Chief Commissioners of Central Tax and Principal Directors General of Central Tax,*
- (b) Chief Commissioners of Central Tax and Directors General of Central Tax,*
- (c) Principal Commissioners of Central Tax and Principal Additional Directors General of Central Tax,*

- (d) *Commissioners of Central Tax and Additional Directors General of Central Tax,*
- (e) *Additional Commissioners of Central Tax and Additional Directors of Central Tax,*
- (f) *Joint Commissioners of Central Tax and Joint Directors of Central Tax,*
- (g) *Deputy Commissioners of Central Tax and Deputy Directors of Central Tax,*
- (h) *Assistant Commissioners of Central Tax and Assistant Directors of Central Tax,*
- (i) *Commissioners of Central Tax (Audit),*
- (j) *Commissioners of Central Tax (Appeals),*
- (k) *Additional Commissioners of Central Tax (Appeals)*
- (l) *Joint Commissioners of Central Tax (Appeals) and*
- (m) *any other class of Central Tax officers sub-ordinate to them as central tax officers may deem fit:*

3.1 Introduction

The CGST Act confers powers for performing various statutory functions on various officers. Officers who are to discharge these functions derive their power and authority from section 3. It is therefore necessary for the efficient administration of the law that often Authority be conferred on designated persons who will be the incumbents occupying positions identified in the law as being the authorized persons to discharge the said functions.

3.2 Analysis

Specific categories of officers have been named in this section whose appointment requires notification by the government. Notifications issued under this section do not require to be laid before Parliament as 'laying before Parliament' is a requirement limited only to exemption notifications and not designating officers under section 3. Only recently, Central excise act has been amended perhaps to align itself in the administrative framework in view of the imminent introduction of GST. Accordingly, Officers under the Central excise act are deemed to be officers appointed under this act.

Also, Government has notified a post of Joint Commissioner (Appeals). This is significant because there are three ranks of officers of Central Tax who will operate as First Appellate Authority and pecuniary limits may be prescribed for each. Second Appellate Authority will continue to be the Tribunal.

Statutory Provision**4. Appointment of Officers**

- (1) *The Board may, in addition to the officers as may be notified by the Government under section 3, appoint such persons as it may think fit to be the officers under this Act.*
- (2) *Without prejudice to the provisions of sub-section (1), the Board may, by order, authorise any officer referred to in clauses (a) to (h) of section 3 to appoint officers of central tax below the rank of Assistant Commissioner of central tax for the administration of this Act.*

Relevant Circulars, Notifications and Clarifications

1. Notification No. 02/2017-Central Tax, dated 19.06.2017 notifying the jurisdiction of Central Tax Officers;
2. Notification No. 14/2017-Central Tax, dated 01.07.2017 issued to assign the jurisdiction and powers of various directorates;
3. Notification No. 39/2017-Central Tax, dated 13.10.2017 read with Notification No. 10/2018-Central Tax, dated 23.01.2018 issued to cross-empower State Tax officers for processing and granting of refunds;
4. Notification No. 2/2017-Integrated Tax, dated 19.06.2017 notifying certain officers empowered to grant registration in case of OIDAR services provided by a person located in a non-taxable territory;
5. Circular No. 3/3/2017 dated 05.07.2017 read with Circular No. 31/05/2018 dated 09.02.2018 issued to clarify the functions of the Proper officers;
6. Circular No. 9/9/2017 dated 18.10.2017 issued regarding the officer authorized for enrolment of GST Practitioners.

4.1 Introduction

All statutory functions cannot be performed by executive officers. There is a necessity to appoint administrative staff to assist executive officers.

4.2 Analysis

The power to appoint executive officers remains with the government but the authority to appoint administrative staff is left to the Board – Central Board of Excise and Customs constituted under the Central Boards of Revenue Act, 1963. The administrative staff make up the entire working team of administrative staff also called 'field formations'. While the authority to appoint administrative staff is vested with the Board, express provision is made to permit officers under section 3 to appoint, for the purposes of Central Tax, certain administrative staff.

This provision ensures an executive order issued by (say) Principal Chief Commissioner or Principal Director-General or any subordinate officer to immediately confer status administrative staff to the erstwhile field formations for purposes of Central Tax.

Statutory Provision

5. Powers of Officers

- (1) *Subject to such conditions and limitations as the Board may impose, an officer of central tax may exercise the powers and discharge the duties conferred or imposed on him under this Act.*
- (2) *An officer of central tax may exercise the powers and discharge the duties conferred or imposed under this Act on any other officer of central tax who is subordinate to him.*
- (3) *The Commissioner may, subject to such conditions and limitations as may be specified in this behalf by him, delegate his powers to any other officer who is subordinate to him.*
- (4) *Notwithstanding anything contained in this section, an Appellate Authority shall not exercise the powers and discharge the duties conferred or imposed on any other officer of central tax.*

5.1 Introduction

Delgatus potest non delegare – the delegate must exercise the power conferred and not sub-delegate. While this is true on the principle of construction of statutes, the very law that creates the power also empowers creation of exception to this principle.

5.2 Analysis

An officer duly appointed under this act needs to be supplied with guidance as regards the manner of exercise of his authority including the boundaries for the same. The more is required to prescribe conditions and limitations for the exercise of powers conferred on officers of central tax during discharging their duties under this act.

Apart from the boundaries laid down, very interestingly power of sub-delegation is conferred on officers of Central Tax. Please note in the event of sub-delegation, the duty to provide superintendence is implicit. While sub-delegation appears to subvert the course of administrative power, in the wisdom of the lawmaker the liberty to sub-delegate can at least be enabled in such a historical and hard-to-amend legislation. It would be interesting to see how this power would be exercised without causing too much dilution and subversion. All the administrative flexibility is provided or at least enabled have been wisely limited to executive officers and not to appellate authorities.

Statutory Provision

- 6. Authorisation of officers of State tax or Union territory tax as proper officer in certain circumstances**
- (1) *Without prejudice to the provisions of this Act, the officers appointed under the State Goods and Services Tax Act or the Union Territory Goods and Services Tax Act are authorised to be the proper officers for the purposes of this Act, subject to such conditions as the Government shall, on the recommendations of the Council, by notification, specify.*
- (2) *Subject to the conditions specified in the notification issued under sub-section (1), —*
- (a) *where any proper officer issues an order under this Act, he shall also issue an order under the State Goods and Services Tax Act or the Union Territory Goods and Services Tax Act, as authorised by the State Goods and Services Tax Act or the Union Territory Goods and Services Tax Act, as the case may be, under intimation to the jurisdictional officer of State tax or Union territory tax;*
- (b) *where a proper officer under the State Goods and Services Tax Act or the Union Territory Goods and Services Tax Act has initiated any proceedings on a subject matter, no proceedings shall be initiated by the proper officer under this Act on the same subject matter.*
- (3) *Any proceedings for rectification, appeal and revision, wherever applicable, of any order passed by an officer appointed under this Act shall not lie before an officer appointed under the State Goods and Services Tax Act or the Union Territory Goods and Services Tax Act.*

6.1 Introduction

With the similarity of the taxing base, it is necessary to develop a mechanism to avoid duplication of tax administration by officers of Central Tax and by officers of State /UT Tax.

6.2 Analysis

For the purposes of administration of this act, it is permitted to authorise officers of State/UT Tax to simultaneously also be the officer of Central Tax. It is interesting to note that officers of State/UT Tax do not relinquish their authority but accept additional authority as officers of Central Tax. However, to do so requires the recommendations of the Council and adherence to the conditions that the government may impose in this regard.

In order to establish non-overlapping of administrative power, it is provided that an officer in respect of central tax is required to duly exercise his authority even in respect of State/UT Tax where the executive action is in respect of the same taxing base. In so doing, the officer of central tax is required to intimate the officer of State/UT Tax in respect of all his actions. Further administrative power has been invoked by the officer of the State/UT Tax in any proceeding, such action will preclude the officer of central tax from exercising any administrative power in respect of transactions covered by the said proceedings.

The officer who has exercised administrative power in any proceeding will continue to be the forum to entertain appeal, rectification or revision in respect of that matter until it is concluded. Surely, this will not result in competition for tax administration enable clear and unambiguous jurisdiction in respect of each proceeding. Industry will closely examine who will exercise administrative power without causing duplication in appearing before tax administration for GST compliance.

Please note that this provision enabling mutual allocation of administrative power between officers of central tax and officers of State/UT Tax opens with the words “*Without prejudice ...*”. As such the provisions conferring power to officers of central tax will not be in derogation of the provisions enabling its mutual allocation. In other words, there may be duplication of powers in respect of same taxable persons or same issues involving said taxable persons but not simultaneous exercise of these powers over the same matter so as to cause parallel proceedings. The role of the Council in guiding such mutual allocation is paramount as also the conditions that the government is authorised to impose in such an exercise.

It is very important to examine in every GST proceeding whether the officer initiating the said proceedings is vested with the authority so to do. It is not uncommon that officers are conferred the authority after they have initiated the any proceedings. In such a situation, the entire proceedings become illegal and in certain cases cannot be restarted due to supervening circumstances or actions taken.

Acquiescence is an important topic to familiarize ourselves, where a person who is unaware of the lack of authority submits to the proceedings initiated is treated to have acquiesced. Such acquiescence robs the person of the right to subsequently question the lack of authority. A hot contest is on the question of whether acquiescence can furnish legality to a patently illegal action. Tax administration will, however, claim it to be so. This itself requires a careful consideration of the scope of authority being exercised and it does good to raise objections on this issue, if it exists, at the earliest opportunity.

Please note the notifications and circulars referred earlier must be carefully studied to understand the scope and extent as well as limits to the powers conferred. The general rule in section 5(2) that – a superior office is empowered to exercise authority vested with the subordinate – does not hold good in all instances. The notification granting the said power must be examined if the powers are conferred on ‘an officer of certain rank’ or ‘officers below the rank’.

The notifications under section 3 and 5 of CGST Act listed earlier are further detailed in the circulars specifying internal allocation of powers. There are yet other sections where the officers are not notified such as Revisional Authority, Appellate Authority, etc. Care should to take to consider the limits of authority vested under the Act so as not to contaminate proceedings undertaken in the absence of lawful authority.

Chapter 3

Levy and Collection of Tax

Sections	Rules
7. Scope of supply	3. Intimation for composition levy
8. Tax liability on composite and mixed supplies	4. Effective date for composition levy
9. Levy and collection	5. Conditions and restrictions for composition levy
10. Composition levy	6. Validity of composition levy
	7. Rate of tax of the composition levy

Statutory Provisions- Effective from 1st July, 2017 to 31st January, 2019

<p>7. Scope of supply</p> <p>(1) <i>For the purposes of this Act, the expression “supply” includes—</i></p> <p>(a) <i>all forms of supply of goods or services or both such as sale, transfer, barter, exchange, licence, rental, lease or disposal made or agreed to be made for a consideration by a person in the course or furtherance of business;</i></p> <p>(b) <i>import of services for a consideration whether or not in the course or furtherance of business;</i></p> <p>(c) <i>the activities specified in Schedule I, made or agreed to be made without a consideration; and</i></p> <p>(d) <i>the activities to be treated as supply of goods or supply of services as referred to in Schedule II.</i></p> <p>(2) <i>Notwithstanding anything contained in sub-section (1), —</i></p> <p>(a) <i>activities or transactions specified in Schedule III; or</i></p> <p>(b) <i>such activities or transactions undertaken by the Central Government, a State Government or any local authority in which they are engaged as public authorities, as may be notified by the Government on the recommendations of the Council,</i></p> <p><i>shall be treated neither as a supply of goods nor a supply of services.</i></p> <p>(3) <i>Subject to the provisions of sub-sections (1) and (2), the Government may, on the recommendations of the Council, specify, by notification, the transactions that are to be treated as—</i></p> <p>(a) <i>a supply of goods and not as a supply of services; or</i></p> <p>(b) <i>a supply of services and not as a supply of goods.</i></p>
--

SCHEDULE I

[See section 7]

ACTIVITIES TO BE TREATED AS SUPPLY EVEN IF MADE WITHOUT CONSIDERATION

1. Permanent transfer or disposal of business assets where input tax credit has been availed on such assets.
2. Supply of goods or services or both between related persons or between distinct persons as specified in section 25, when made in the course or furtherance of business:
Provided that gifts not exceeding fifty thousand rupees in value in a financial year by an employer to an employee shall not be treated as supply of goods or services or both.
3. Supply of goods—
 - (a) by a principal to his agent where the agent undertakes to supply such goods on behalf of the principal; or
 - (b) by an agent to his principal where the agent undertakes to receive such goods on behalf of the principal.
4. Import of services by a taxable person from a related person or from any of his other establishments outside India, in the course or furtherance of business

SCHEDULE II

[See section 7]

ACTIVITIES TO BE TREATED AS SUPPLY OF GOODS OR SUPPLY OF SERVICES

1. Transfer
 - (a) any transfer of the title in goods is a supply of goods;
 - (b) any transfer of right in goods or of undivided share in goods without the transfer of title thereof, is a supply of services;
 - (c) any transfer of title in goods under an agreement which stipulates that property in goods shall pass at a future date upon payment of full consideration as agreed, is a supply of goods
2. Land and Building
 - (a) any lease, tenancy, easement, licence to occupy land is a supply of services;
 - (b) any lease or letting out of the building including a commercial, industrial or residential complex for business or commerce, either wholly or partly, is a supply of services.

3. Treatment or process
Any treatment or process which is applied to another person's goods is a supply of services.
4. Transfer of business assets
- (a) where goods forming part of the assets of a business are transferred or disposed of by or under the directions of the person carrying on the business so as no longer to form part of those assets, whether or not for a consideration, such transfer or disposal is a supply of goods by the person;
- (b) where, by or under the direction of a person carrying on a business, goods held or used for the purposes of the business are put to any private use or are used, or made available to any person for use, for any purpose other than a purpose of the business, whether or not for a consideration, the usage or making available of such goods is a supply of services;
- (c) where any person ceases to be a taxable person, any goods forming part of the assets of any business carried on by him shall be deemed to be supplied by him in the course or furtherance of his business immediately before he ceases to be a taxable person, unless—
- (i) the business is transferred as a going concern to another person; or
- (ii) the business is carried on by a personal representative who is deemed to be a taxable person.
5. Supply of services
The following shall be treated as supply of services, namely:—
- (a) renting of immovable property;
- (b) construction of a complex, building, civil structure or a part thereof, including a complex or building intended for sale to a buyer, wholly or partly, except where the entire consideration has been received after issuance of completion certificate, where required, by the competent authority or after its first occupation, whichever is earlier.
- Explanation.—For the purposes of this clause—
- (1) the expression "competent authority" means the Government or any authority authorised to issue completion certificate under any law for the time being in force and in case of non-requirement of such certificate from such authority, from any of the following, namely:—
- (i) an architect registered with the Council of Architecture constituted under the Architects Act, 1972; or

- (ii) a chartered engineer registered with the Institution of Engineers (India); or
 - (iii) a licensed surveyor of the respective local body of the city or town or village or development or planning authority;
- (2) the expression "construction" includes additions, alterations, replacements or remodelling of any existing civil structure;
- (c) temporary transfer or permitting the use or enjoyment of any intellectual property right;
 - (d) development, design, programming, customisation, adaptation, upgradation, enhancement, implementation of information technology software;
 - (e) agreeing to the obligation to refrain from an act, or to tolerate an act or a situation, or to do an act; and
 - (f) transfer of the right to use any goods for any purpose (whether or not for a specified period) for cash, deferred payment or other valuable consideration.
6. Composite supply
- The following composite supplies shall be treated as a supply of services, namely:—
- (a) works contract as defined in clause (119) of section 2; and
 - (b) supply, by way of or as part of any service or in any other manner whatsoever, of goods, being food or any other article for human consumption or any drink (other than alcoholic liquor for human consumption), where such supply or service is for cash, deferred payment or other valuable consideration.
7. Supply of Goods
- The following shall be treated as supply of goods, namely:—
- Supply of goods by any unincorporated association or body of persons to a member thereof for cash, deferred payment or other valuable consideration.

SCHEDULE III

[See section 7]

ACTIVITIES OR TRANSACTIONS WHICH SHALL BE TREATED NEITHER AS A SUPPLY OF GOODS NOR A SUPPLY OF SERVICES

1. Services by an employee to the employer in the course of or in relation to his employment.
2. Services by any court or Tribunal established under any law for the time being in force.

3. (a) the functions performed by the Members of Parliament, Members of State Legislature, Members of Panchayats, Members of Municipalities and Members of other local authorities;
 - (b) the duties performed by any person who holds any post in pursuance of the provisions of the Constitution in that capacity; or
 - (c) the duties performed by any person as a Chairperson or a Member or a Director in a body established by the Central Government or a State Government or local authority and who is not deemed as an employee before the commencement of this clause.
 4. Services of funeral, burial, crematorium or mortuary including transportation of the deceased.
 5. Sale of land and, subject to clause (b) of paragraph 5 of Schedule II, sale of building.
 6. Actionable claims, other than lottery, betting and gambling.
- Explanation.—For the purposes of paragraph 2, the term "court" includes District Court, High Court and Supreme Court.

7. Scope of supply

- (1) *For the purposes of this Act, the expression "supply" includes—*
 - (a) *all forms of supply of goods or services or both such as sale, transfer, barter, exchange, licence, rental, lease or disposal made or agreed to be made for a consideration by a person in the course or furtherance of business;*
 - (b) *import of services for a consideration whether or not in the course or furtherance of business; and*
 - (c) *the activities specified in Schedule I, made or agreed to be made without a consideration;*
- (1A) *Where certain activities or transactions constitute a supply in accordance with the provisions of sub-section (1), they shall be treated either as supply of goods or supply of services as referred to in Schedule II.*
- (2) *Notwithstanding anything contained in sub-section (1), —*
 - (a) *activities or transactions specified in Schedule III; or*
 - (b) *such activities or transactions undertaken by the Central Government, a State Government or any local authority in which they are engaged as public authorities, as may be notified by the Government on the recommendations of the Council,*

shall be treated neither as a supply of goods nor a supply of services.
- (3) *Subject to the provisions of sub-sections (1), (1A) and (2), the Government may, on*

the recommendations of the Council, specify, by notification, the transactions that are to be treated as—

- (a) *a supply of goods and not as a supply of services; or*
- (b) *a supply of services and not as a supply of goods.*

SCHEDULE I

[See section 7]

ACTIVITIES TO BE TREATED AS SUPPLY EVEN IF MADE WITHOUT CONSIDERATION

1. Permanent transfer or disposal of business assets where input tax credit has been availed on such assets.
2. Supply of goods or services or both between related persons or between distinct persons as specified in section 25, when made in the course or furtherance of business:
Provided that gifts not exceeding fifty thousand rupees in value in a financial year by an employer to an employee shall not be treated as supply of goods or services or both.
3. Supply of goods—
 - (a) by a principal to his agent where the agent undertakes to supply such goods on behalf of the principal; or
 - (b) by an agent to his principal where the agent undertakes to receive such goods on behalf of the principal.
4. Import of services by a **person** from a related person or from any of his other establishments outside India, in the course or furtherance of business

SCHEDULE II

[See section 7]

ACTIVITIES OR TRANSACTIONS TO BE TREATED AS SUPPLY OF GOODS OR SUPPLY OF SERVICES

1. Transfer
 - (a) any transfer of the title in goods is a supply of goods;
 - (b) any transfer of right in goods or of undivided share in goods without the transfer of title thereof, is a supply of services;
 - (c) any transfer of title in goods under an agreement which stipulates that property in goods shall pass at a future date upon payment of full consideration as agreed, is a supply of goods

2. Land and Building
 - (a) any lease, tenancy, easement, licence to occupy land is a supply of services;
 - (b) any lease or letting out of the building including a commercial, industrial or residential complex for business or commerce, either wholly or partly, is a supply of services.
3. Treatment or process

Any treatment or process which is applied to another person's goods is a supply of services.
4. Transfer of business assets
 - (a) where goods forming part of the assets of a business are transferred or disposed of by or under the directions of the person carrying on the business so as no longer to form part of those assets, whether or not for a consideration, such transfer or disposal is a supply of goods by the person;
 - (b) where, by or under the direction of a person carrying on a business, goods held or used for the purposes of the business are put to any private use or are used, or made available to any person for use, for any purpose other than a purpose of the business, whether or not for a consideration, the usage or making available of such goods is a supply of services;
 - (c) where any person ceases to be a taxable person, any goods forming part of the assets of any business carried on by him shall be deemed to be supplied by him in the course or furtherance of his business immediately before he ceases to be a taxable person, unless—
 - (i) the business is transferred as a going concern to another person; or
 - (ii) the business is carried on by a personal representative who is deemed to be a taxable person.
5. Supply of services

The following shall be treated as supply of services, namely:—

 - (a) renting of immovable property;
 - (b) construction of a complex, building, civil structure or a part thereof, including a complex or building intended for sale to a buyer, wholly or partly, except where the entire consideration has been received after issuance of completion certificate, where required, by the competent authority or after its first occupation, whichever is earlier.

Explanation.—For the purposes of this clause—

 - (1) the expression "competent authority" means the Government or any authority authorised to issue completion certificate under any law for the time being in

force and in case of non-requirement of such certificate from such authority, from any of the following, namely:—

- (i) an architect registered with the Council of Architecture constituted under the Architects Act, 1972; or
 - (ii) a chartered engineer registered with the Institution of Engineers (India); or
 - (iii) a licensed surveyor of the respective local body of the city or town or village or development or planning authority;
- (2) the expression "construction" includes additions, alterations, replacements or remodelling of any existing civil structure;
- (c) temporary transfer or permitting the use or enjoyment of any intellectual property right;
 - (d) development, design, programming, customisation, adaptation, upgradation, enhancement, implementation of information technology software;
 - (e) agreeing to the obligation to refrain from an act, or to tolerate an act or a situation, or to do an act; and
 - (f) transfer of the right to use any goods for any purpose (whether or not for a specified period) for cash, deferred payment or other valuable consideration.

6. Composite supply

The following composite supplies shall be treated as a supply of services, namely:—

- (a) works contract as defined in clause (119) of section 2; and
- (b) supply, by way of or as part of any service or in any other manner whatsoever, of goods, being food or any other article for human consumption or any drink (other than alcoholic liquor for human consumption), where such supply or service is for cash, deferred payment or other valuable consideration.

7. Supply of Goods

The following shall be treated as supply of goods, namely:—

Supply of goods by any unincorporated association or body of persons to a member thereof for cash, deferred payment or other valuable consideration.

SCHEDULE III

[See section 7]

ACTIVITIES OR TRANSACTIONS WHICH SHALL BE TREATED NEITHER AS A SUPPLY OF GOODS NOR A SUPPLY OF SERVICES

1. Services by an employee to the employer in the course of or in relation to his employment.
2. Services by any court or Tribunal established under any law for the time being in force.
3.
 - (a) the functions performed by the Members of Parliament, Members of State Legislature, Members of Panchayats, Members of Municipalities and Members of other local authorities;
 - (b) the duties performed by any person who holds any post in pursuance of the provisions of the Constitution in that capacity; or
 - (c) the duties performed by any person as a Chairperson or a Member or a Director in a body established by the Central Government or a State Government or local authority and who is not deemed as an employee before the commencement of this clause.
4. Services of funeral, burial, crematorium or mortuary including transportation of the deceased.
5. Sale of land and, subject to clause (b) of paragraph 5 of Schedule II, sale of building.
6. Actionable claims, other than lottery, betting and gambling.
7. Supply of goods from a place in the non-taxable territory to another place in the non-taxable territory without such goods entering into India.
8.
 - (a) Supply of warehoused goods to any person before clearance for home consumption;
 - (b) Supply of goods by the consignee to any other person, by endorsement of documents of title to the goods, after the goods have been dispatched from the port of origin located outside India but before clearance for home consumption

Explanation 1.—For the purposes of paragraph 2, the term "court" includes District Court, High Court and Supreme Court.

Explanation 2.— For the purposes of paragraph 8, the expression "warehoused goods" shall have the same meaning as assigned to it in the Customs Act, 1962

Relevant circulars, notifications, clarifications issued by Government

1. Notification No. 14/2017-Central Tax (Rate), dated 28.06.2017 was issued to notify the supplies which shall be treated neither as a supply of goods nor a supply of service;
2. Circular No. 35/9/2018 dated 05.03.2018 was issued regarding taxability of services provided by a member of the Joint Venture (JV) to the JV and vice versa and inter se between the members of the JV;
3. Circular No. 34/8/2018 dated 01.03.2018 was issued clarifying on the taxability of certain services;
4. Circular No. 1/1/2017-IGST dated 07.07.2017 was issued regarding Inter-state movement of various modes of conveyance, carrying goods or passengers or for repairs and maintenance to be treated as neither supply of goods nor supply of services;
5. Circular No. 21/21/2017 dated 22.11.2017 to clarify on Inter-state movement of rigs, tools and spares, and all goods on wheels like cranes;
6. Circular No. 10/10/2017-GST dated 18.10.2017 to clarify on goods moved within the State or from the State of registration to another State for supply on approval basis to be covered u/s 7 and chargeable to tax u/s 9.
7. Chapter three of the compilation of the GST Flyers as issued by the CBIT can be referred to for a gist of the statutory provisions, titled 'The Meaning and Scope of Supply'.

Related provisions of the Statute

Section or Rule	Description
Section 2(31)	Definition of Consideration
Section 2(17)	Definition of Business
Section 2(5)	Definition of Agent
Section 2(88)	Definition of Principal
Section 15	Value of taxable Supply
Section 25	Registration
Section 16	Input tax credit
Chapter IV – Rules	Determination of Value of Supply Rules

7.1 Introduction

While the definition of the word 'supply' is inclusive, the legislature has carefully chosen not to use the word/s such as "means", or "means and includes", "shall mean", or "shall include", etc.

A careful consideration of the above explanation would indicate that the draftsman is uncertain about any transaction of supply that could escape the ambit of levy. It is for this reason that despite being exhaustive, the legislature has used the word “includes”.

A plain reading of the definition of the word ‘supply’ contained in Section 7(1) would invite anybody’s attention to the 8 words – sale, transfer, barter, exchange, license, rental, lease or disposal. Look at these 8 words – they are arranged in a descending order. Words 2 to 8 was a subject matter of challenge under the erstwhile State-level VAT Laws. This ambiguity has been done away with in the GST Laws. These 8 words together form a ‘continuum’. The last 7 words complete the absoluteness of the word ‘sale’ and / or supply.

The Model GST Law released in June 2016 had included the meaning of the term ‘Supply’ within the clauses of the definition Section. However, in GST law, the term ‘supply’ is defined by way of a separate and distinct Section, Section 7. One understands that the meaning attributed to the term “Supply” is of very wide amplitude, but yet, an inclusive one. It must be noted that this term is ordinarily attributable to an ‘outward supply’, unless the context so requires that the term refers to an inward supply - say in case of importation of services or in respect of transactions without consideration etc. Many things come within ‘supply’ but not everything is ‘supply’. Supply too has boundaries and many transactions are excluded from its grasp. This points to a clear understanding that expression ‘supply’, although inclusively defined, does have a recipe or a set of ingredients that each transactions must be tested against to see if it is or is not ‘supply’.

The word ‘supply’ could be understood as actual or implied. Implied supplies are governed by the relevant Schedules. The three pillars of a supply would be:

- (a) subject – viz. goods, services or goods treated as services. One cannot find an instance in the GST statute where a supply of services is treated as a supply of goods.
- (b) place of supply – to identify whether the transaction is an inter-State supply or an intra-State supply
- (c) time of supply – where legislature specifies ‘when’ the incidence is attracted.

7.2 Analysis

Supply:

- (a) **Generic meaning of ‘supply’:** Supply includes all forms of supply (goods and / or services) and includes agreeing to supply when the supply is for a consideration and in the course or furtherance of business (as defined under Section 7 of the Act). It specifically provides for the inclusion of the following 8 classes of transactions:
 - (i) Sale
 - (ii) Transfer
 - (iii) Barter
 - (iv) Exchange

- (v) License
- (vi) Rental
- (vii) Lease
- (viii) Disposal

The word 'supply' is all-encompassing, subject to exceptions carved out in the relevant provisions. There are various ingredients that differentiate each of these eight forms of supply. On a careful consideration of the purposeful usage of these eight adjectives to enlist them as 'forms' of supply, it becomes clear that the legislature makes its intention known by the choice of words that are deliberate and unambiguous. However, the definition starts off with the phrase – "For the purpose of this Act", which means that wherever the term supply has been used anywhere in the Act, the meaning should always be derived from this section 7 and cannot be substituted by any other understanding of the term supply.

Barter means a "thing or commodity" given in 'in return of' another. In other words, no value is fixed- viz., barter of wrist watch with a wall clock.

Disposal means distribution, transferring to new hands, extinguishment of control over, forfeit or pass over control to another.

Transfer means to pass over, convey, relinquishment of a right, abandonment of a claim, alienate, each or any of the above acts, lawfully.

A tentative attempt at identifying the characteristics of each of these forms of supply is provided below:

Forms of Supply	Two Capable Persons	Consideration in Money (Price)	Willingness to Contract		Delivery of Possession	Permanent alienation	Consensus	Object of Supply		
			Seller	Buyer				Identity of Object		
								Services	Movable	Immovable
Sale	✓	✓	✓	✓	✓	✓	✓	x	✓	NA
Transfer	✓	✓	x	✓	✓	✓	✓	x	✓	✓
Barter	✓	x	✓	✓	✓	✓	✓	✓	✓	x
Exchange	✓	✓/x	✓	✓	✓	✓	✓	x	x	✓
License	✓	✓	✓	✓	x	x	✓	✓	✓	✓
Rental	✓	✓	✓	✓	✓	x	✓	x	✓	x
Lease	✓	✓	✓	✓	✓	x	✓	x	✓	✓
Disposal	✓	✓	✓	x/✓	✓	✓	x	x/✓	✓	x

On an understanding of the above chart, one may infer that 'supply' is not a boundless word of uncertain meaning. The inclusive part of the opening words in this clause may be understood to include everything that supply is generally understood to be PLUS the ones that are enlisted. It must be admitted that the general understanding of the word 'supply' is but an amalgam of these 8 forms of supply.

Any attempt at expanding this list of 8 forms of supply, in case of goods, must be attempted with great caution. Attempting to find other forms of supply has in the normal course not yielded the desired results. However, transactions that do not amount to supply have been discovered viz., - transactions in the nature of an assignment where

one person steps into the shoes of another, appears to slip away from the scope of supply, as well as transactions where goods are destroyed without a transfer of any kind taking place. Perhaps, the case of destruction of goods is not included within the meaning of 'supply' considering that the input tax credits in respect of destroyed goods is a blocked credit. However, the contradiction may continue until a clarification is issued to state whether the blocked credits is in respect of goods that have been destroyed before the availment of credits, or is applicable even in case where goods are destroyed after the credits have been availed in respect of such goods.

Now looking at 'services', we find that the adjectives used to describe the 8 forms of supply in this clause are akin to transactions involving goods and not services. Services other than licensing, rental and leasing services have not been specifically included in the meaning of the term 'supply'. However, transactions involving services are also required to be passed through the same criteria for determination of supply. In doing so, a slight adjustment in the way of looking at transactions involving services is necessary so as to substitute the object of supply from goods to services while administering the tests for determining the forms of supply involving services. In other words, the same 8 forms of supply must be applied in relation to services but with adjustment that is understood by the expression *mutatis mutandis*.

The law has provided an inclusive meaning to the word 'supply' which implies that the specific transactions which are listed in the said Section are only illustrative.

It is essential that such supplies should be by the supplier who is engaged in business. ('Business' as defined in Section 2(17) of the Act). However, in case of import of services for a consideration, even if such services are imported otherwise than in the course or furtherance of business, it would be a supply.

The word 'supply' should be understood as follows:

- It should involve delivery of goods and / or services to another person; The word 'delivery' must be understood from allied laws such as The Sale of Goods Act, 1930 or the Contract Laws; Delivery could be actual, physical, constructive, deemed etc.
- Supply will be treated as 'wholly one supply' – if the goods and / or services supplied are listed in Schedule II or could be classified as a composite supply or mixed supply;
- It should involve quid-pro-quo – viz., the supply transaction requires something in return, which the person supplying will obtain, which may be in money / monetary terms / in any other form (except in cases of activities specified in Schedule I which are deemed to be supplies, even when made without consideration). What is received in return need not be always in 'money'; it can partly/wholly be in money's worth too (non-monetary in nature);

- Transfer of property in goods from the supplier to recipient is not necessary viz., lease or hiring of goods;

It is essential that all the above forms of transactions including the extended and generic meaning given to the word 'supply' should be made for a 'consideration'. The only exception for this rule of construction will be cases specified in Schedule I. Absence of consideration (as defined in Section 2(31)) will take away the character of the word 'supply' under this clause, and accordingly, the transaction will not attract tax. It is important to note supplies listed in Schedule I would nevertheless attract the wrath of tax, even when made without consideration. One has to therefore, be very careful, while analysing the tax implications in respect of supplies listed in Schedule I.

- (b) **Supply should be in the course or furtherance of business:** For a transaction to qualify as 'supply', it is essential that the same is 'in the course' or 'furtherance of business'. This implies that it is only such of those supplies of goods and / or services by a business entity would be liable to tax, so long as it is 'in the course' or 'furtherance of business'. Supplies that are not in the course of business or in furtherance of business will not qualify as 'supply' for the purpose of levy of tax, except in case of import of service for consideration, where the service is treated as a supply even if it is not made in the course or furtherance of business.

The expression 'in the course of' must be construed differently from 'in the course or'. The GST Laws use the expression 'in the course or' and careful analysis is therefore, essential. The expression 'in the course' appearing in Section 7(1)(a) does not appear in Section 7(1)(b) or Section 7(1)(c) or Section 7(1)(d). However, one cannot lose sight of the fact that the expression 'in the course' is used selectively in respect of transactions listed in Schedule I, II or III. The import of this would mean that the meaning attributable to the expression 'in the course' would apply only in respect of such of those transaction, so listed, in the relevant Schedules.

Let us now try to understand the meaning of the phrase 'in the course'. The expression 'in the course' implies not only a period of time during which the movement or transaction is in progress, but postulates a connected relationship. Therefore, the class of transactions needs to be analysed and cannot be randomly applied to the provisions of Section 7 or Section 8. So construed, the word 'or' appearing in the phrase or expression 'in the course or furtherance of business' assumes importance. When read in a proper perspective, the preposition 'or' actually bisects the entire phrase into two limbs. Therefore, the 8 forms of supply would tantamount to transaction of supply when such supplies are in the *course of business*, or in the *furtherance of business*. Therefore, the legislature has supplied huge amount of elasticity in understanding the meaning of the term 'supply'.

The term 'business' has been defined under the GST Laws to include:

- (i) a wide range of activities (being "trade, commerce, manufacture, profession, vocation, adventure, wager or any similar activity"),
- (ii) "whether or not it is for a pecuniary benefit",
- (iii) regardless of the "volume, frequency, continuity or regularity" of the activity.
- (iv) and those "in connection with or incidental or ancillary to" such activities.

A recent order of the Authority for Advance Ruling – Kerala has ruled, in a matter involving recovery of food expenses from employees for the canteen facility provided by a Company, that such recovery falls within the definition of 'outward supply' and are therefore taxable outward supplies under the GST law. In paragraph 9 of the order, the AAR-Kerala has concluded that the supply of food by the applicant (Company) to its employees would definitely come under clause (b) of Section 2(17) as a transaction incidental or ancillary to the main business and thereby the test of 'in the course or furtherance of business' is met by the applicant. – *Order No. CT/531/18-C3 dated 26.03.2018.*

Also a question came up before Authority for Advance Ruling – Karnataka in the matter of Columbia Asia, whether allocation of expenses to other registered units by Corporate Office tantamount to supply of services between related or distinct persons as per Entry 2 to Schedule I to CGST Act and accordingly liable to tax. The Authority ruled that the activities performed by the employees at the corporate office in the course of or in relation to employment such as accounting, other administrative and IT system maintenance for the units located in the other states as well i.e. distinct persons as per Section 25(4) of the CGST Act shall be treated as supply as per Entry 2 of Schedule I of the CGST Act.

Drawing similarities from the erstwhile State-level VAT laws, it follows that the said transaction should be with a commercial motive, whether or not there is a profit motive in it or its frequency / regularity. E.g.: sale of goods in an exhibition, participation in a trade fair, warranty supplies, sale of used assets / scrap sales, etc. would be activities in the course of business.

- (c) **Import of service will be taxable in the hands of the recipient (importer):** The word 'supply' includes import of a service, made for a consideration ('consideration' as defined in Section 2(31)) and whether or not in the course or furtherance of business. This implies that import of services even for personal consumption would qualify as 'supply' and therefore, would be liable to tax. This would not be subject to the threshold limit for registration, as tax would be payable in case of import of services on reverse charge basis, requiring the importer of service to compulsorily obtain registration in terms of Section 24(ii) of the Act. However, the GST law has ensured that persons who are **not** engaged in any business activities will not be required to obtain registration and pay tax under reverse charge mechanism, and it turn, requires the supplier of services

located outside India, to obtain registration for the OIDAR (online information and database access and retrieval) services only

Note: Import of services is included within the meaning of 'supply' under the CGST / SGST Acts. However, it would be liable to IGST since it would not be an intra-State supply. In fact, Section 2(21) of IGST Act has adopted the meaning of 'supply' from CGST/SGST Act.

- (d) **Transactions without consideration:** The law lists down, exhaustively, cases where a transaction shall be treated as a 'supply' even though there is no consideration. Such transactions are listed in Schedule I. Once an activity is deemed to be a 'supply' under the paragraph listed in Schedule I, the value of taxable supply shall be determined in terms of provisions of Section 15(4) of the Act read with Chapter IV (Determination of Value of Supply) of CGST Rules.

In this regard, it may be noted that on careful consideration of the essential ingredients of a valid contract, it cannot be disputed that a contract without consideration is not a contract at all. The reference made to 'transactions without consideration' in Schedule I does not imply that a void contract is being made valid, by GST laws. It can be argued that transactions listed in Schedule I, are not contracts at all owing to lack of consideration in terms of the Contract Laws. Even though they are not contracts, by legal fiction, flowing from section 7(1)(c) read with Schedule I, they will be nevertheless regarded as a 'supply' and made taxable. As can be seen from the above, in all other clauses of section 7(1), supply exists within a valid contract, but in select circumstances supply is imputed by legal fiction in the absence of a contract. It is therefore important not to extrapolate this legal fiction beyond the specific cases to which the law imputes this fiction.

The activities specified in Schedule I are analysed in the ensuing paragraphs:

1. **Permanent transfer or disposal of business assets where input tax credit has been availed on such assets.**
 - a. Of the 8 forms of supply, the only forms that qualify as a supply, under this category are 'transfer' and 'disposal'. Other 6 forms of supply listed in section 7(1)(a) would not stand categorised in this paragraph, given that there is (a) an element of a consideration that is intrinsic to the form, such as the case of a sale or barter or exchange, or (b) there is no business asset that is permanently transferred such as in the case of a licence or rental or lease, or any other service for that matter.
 - b. Ordinarily, there can be no permanent transfer in case of goods sent for job work. The aspect of sending goods on job work is not a supply, has been clarified vide Circular No.38/12/2018 dated 26.03.2018. However, where a registered person has purchased any moulds, tools, etc. and has sent the same to the job worker, there is a good chance that the goods are never

returned, given that the time limits specified in Section 143 for goods sent for job work does not apply to moulds, tools and other specified goods.

- c. It may be noted that this paragraph conjoins two disjointed activities/transactions viz., (a) permanent transfer; and (b) disposal of business assets where input tax credit has been availed on such assets. There is a school of thought that permanent transfer without consideration is in itself an item covered under Schedule I whether or not any credit is claimed on such asset. However, there is a second school of thought, not widely followed, who strongly believe that both permanent transfer and disposal have to be in respect of a business asset on which credit is availed. For instance, where a capital asset has been procured, say, by a distillery for the purpose of manufacture of alcoholic beverages, no input tax credit would have been availed on such asset. Accordingly, there would be no output tax payable if the asset is permanently transferred to another entity (unrelated), if the transfer is without consideration, going by the second school of thought. However, if consideration exists, there can be no escape from levy. Support can be found in the way relief is granted to the 'disposal of business assets'. If disposal is anyway one of the forms of supply, how can disposal be excused where credit is not availed. This is explained when credit is reversed in case of disposal (as contemplated in section 17(5)(h) of the CGST Act), there cannot be a levy again by the fiction in Schedule I on this disposal. Now, if Proprietor were to take away a car used in the business, can tax incidence be excused simply because credit was not allowed originally. Care must be taken to identify how the disjointed expression in schedule I is understood
- d. In the above context, business asset need not always be goods, it can as well be service that could be permanently transferred which could attract the above provisions Eg: unexpired right in a business franchise permanently transferred to another person.
- e. While the word 'transfer' in this Entry suggests that there should be another person who would receive the business assets, there is no requirement of another person in the case of 'disposal'. Therefore, if a business asset on which credit is claimed has been discarded, the transaction shall be regarded as a supply.
- f. Business assets procured for the purpose of serving the requirements of 'Corporate Social Responsibility', being a statutorily imposed obligation' may be contended to be a procurement made in the course or furtherance of business, and an attempt can be made to avail input tax credit. The issue would however remain contentious and there are no precedents. However, there would be no escape from the levy of tax on the transaction, if the asset is

permanently transferred. The treatment would be no different even in the case of a donation.

- g. **ADVANCE RULING ON THE CAPTIONED MATTER:** -AAR, MAHARASHTRA vs. CMS Info Systems Ltd.- *“Whether disposal of scrap vehicles for consideration is a sale and section 7 explaining expression 'supply' covers supply of goods such as sale or disposal made for a consideration and it further, says that supply has to be in course or furtherance of business - Held, yes - Applicant was engaged in business of having a cash management network involving transportation of cash - Disposal of cash carrying vans was a transaction in connection with or incidental or ancillary to business of having a cash management network - As and when vehicles became scrap, they had to be disposed of and proceeds therefrom to be identified as income for business which was reflected in profit and loss account of business - Thus, buying new assets and discarding old and unusable assets was an activity in course of carrying on business - Whether therefore, supply of motor vehicles as scrap after its usage was an activity of 'supply' in course or furtherance of business and such transaction would attract GST - Held, yes”*

2. Supply of goods or services or both between related persons or between distinct persons as specified in section 25, when made in the course or furtherance of business:

Provided that gifts not exceeding fifty thousand rupees in value in a financial year by an employer to an employee shall not be treated as supply of goods or services or both

- a. The deemed supplies covered in this paragraph are based on a relationship between the supplier and recipient. The relationship covered under this paragraph as related persons defined by way of an explanation to Section 15 and distinct persons in terms of Section 25(4) and 25(5) of the Act.
- b. Transactions with distinct persons are normally without consideration since they are part of the same entity located in different geographies, unless the accounting system is so sophisticated or so devised, that it treats the locations in each State as a separate / independent entity even for book-keeping purposes and effects payments in monetary terms. Let us take instances of transactions between distinct persons that are not traceable in the books of account, but requires attention from the perspective of this paragraph in the Schedule:
- i. Stock transfers e.g., transfer of sub-assemblies, semi-finished goods or finished goods;
 - ii. Transfer of new or used capital goods/fixed assets – including movement of laptops when employees are transferred from one location to another;

- iii. Bill-to ship-to transactions wherein the vendor issues the invoice to the corporate office and ships the goods to the branch office;
 - iv. Centralised management function like Board of Directors, Finance, Accounts, HR, Legal, procurement functions and other corporate functions at one location say corporate office and the entity having multiple registrations in various states results in supply of management services by the corporate office to distinct persons;
 - v. A transaction of sale of goods from one registration and providing after sales support or warranty services/replacement services by another registration of the same entity;
 - vi. Contract awarded by a customer to an entity at the corporate office from where the centralized billing to the customer is made but the execution of the contract is carried out through various registrations of the same entity located in other / multiple States.
 - vii. Permitting employees to make use of the office assets for personal use – say usage of motor vehicles, laptops, printers, scanners, etc.
- c. It appears that this paragraph, has an overriding effect on the first paragraph of the Schedule relating to transfer or disposal. In other words, in case a business asset is permanently transferred to a distinct person, the transaction although out of scope of paragraph 1, would be treated as a supply in terms of this paragraph, considering that this paragraph does not impose any such condition on the transaction. The provisions would equally apply even in the case of assets procured in the pre-GST regime. Please note that a transaction that is already a 'supply' is now furnished a special treatment by the fiction in Schedule I in this paragraph and in the next unlike paragraph 1 (which was not a supply but is deemed to be one by this fiction).
- d. The explanation appended to Section 15 of the CGST Act provides that an employer and employee will be deemed to be "related persons". Accordingly, supplies by employer to employees would be liable to tax, if made in the course or furtherance of business, even though these supplies are made without consideration, except:
- i. Gifts by an employer to an employee of value up to Rs 50,000 (to be understood as inclusive of taxes, as read with Rule 35 of the CGST Rules) in a financial year (whether this value needs to be pro-rated in the first year of implementation of GST / first year of commencement of business is a moot question; however, the presumption is that a part of the financial year would be construed as a whole year);

- ii. Cash gifts of any value, given that the 'transaction in money' is not a subject matter of supply as the same receives treatment as a taxable salary in the hands of the employee;
 - iii. Services by employee to the employer in the course of or in relation to his employment – treated as neither a supply of goods nor a supply of services.
- e. The question that arises as to what constitutes a gift is discussed in the following paras.
- i. Gift has not been defined in the GST laws.
 - ii. In common parlance, gift when made without consideration is voluntary in nature and is normally made occasionally.
 - iii. It cannot be demanded as a matter of right by the employee and the employee cannot move a court of law for obtaining a gift. However, if any gift, by whatever name called, is a right of the employee in terms of the employment contract / employee policy of the entity, then such gift shall be treated as emoluments arising out of the employment(including perquisites),and cannot be treated as a supply.
 - iv. As a corollary, one can argue that the scope and ambit of the word 'supply' also includes a transaction of a barter / exchange, in which case, the transaction may be regarded a taxable supply. In such a case, the question that would arise is as to whether a salary paid in non-monetary terms will attract GST. However, the GST Act contains a dedicated Valuation Rule (Rule 27) which contains the modus operandi to arrive at the value of the supply the consideration of which is made either wholly or partly in non-monetary terms.
 - v. The credit restriction on membership of a club, health and fitness centre [under Section 17 (5) (b) (ii)] would not apply where the employer provides the facilities to its employees, whether or not for a consideration, given that such a supply without consideration, would also be deemed to be an outward supply under this paragraph of the Schedule.
 - vi. Where gifts are liable to tax under this Schedule, it would be fair and proper to treat such gifts as taxable outward supplies, and therefore, credit thereon may not be required to be restricted under Section 17(5)(h).
 - vii. It may also be noted that a gift need not always be in terms of goods. A service can also constitute a gift, such as gift vouchers for a beauty treatment.
 - viii. Another question which arises that is on what value will the GST liability be calculated in case the gift amount exceeds Rs.50,000/-. Although it is not

expressly mentioned in the GST Act. But a reasonable construction can be drawn that GST shall be levied on the whole amount in case the gift amount exceeds Rs. 50,000/-.

3. Supply of goods—

(a) by a principal to his agent where the agent undertakes to supply such goods on behalf of the principal; or

(b) by an agent to his principal where the agent undertakes to receive such goods on behalf of the principal.

a. The definition of the terms 'agent' and 'principal' have to be understood contextually and have been reproduced below:

- Section 2(5) of the Act – “Agent means a person, including a factor, broker, commission agent, arhatia, del credere agent, an auctioneer or any other mercantile agent, by whatever name called, who carries on the business of supply or receipt of goods or services or both on behalf of another”.
- Section 2(88) of the Act – “Principal means a person on whose behalf an agent carries on the business of supply or receipt of goods or services or both”.

b. Where an Agent receives goods directly from the Principal, or if the Principal's vendor directly dispatches goods to the location of the agent, the Principal shall be required to treat the movement as an outward supply of goods by virtue of this clause. If understood in its proper perspective, when an agent receives goods on behalf of the Principal and thereafter issues the goods to the Principal, the transaction will be regarded as a supply by the Agent to the Principal.

c. An important question that may arise is - as to how the transaction would appear to the ultimate recipient of a supply, when effected by the Principal through the Agent, or to the supplier who effects the supply to the Principal through an Agent. An analysis of the transaction where the Principal effects a supply through an Agent is provided as follows:

- i. The Principal shall recognise the transfer of goods to the Agent as a supply, at the time of such transfer.
- ii. When the Agent supplies such goods to the third-party recipient, the Principal would recognise revenue as a supply (sale) in his books of account.
- iii. The Agent would, however, issue the invoice to the third-party recipient in the name of the Principal, while also incorporating the

- Agent's own details as the supplier, and discharge taxes on the supply.
- iv. The third-party recipient would receive the credits on account of this supply from the GSTIN of the Agent and not the Principal.
 - v. To this extent, the Principal's supplies in the GST returns will reflect a lower value as compared to the actual revenue against the supplies, since the value of supply to an Agent would normally, be lower than the actual sale price.
 - vi. The value of supplies in the GST returns of the Agent would be much higher than the actual revenues earned, which would be limited to the commission income.
 - vii. It is pertinent to note that the Agent shall be required to issue an invoice on the Principal for the value of service provided by him to earn his commission income but without GST as tax has already been levied on commission in the form of selling price of the goods.
 - viii. **Statutory Update:** - As per Notification No. 15/2018- Central Tax (Rate) dated 26.07.2018 services supplied by Direct Selling Agents (Other than Body Corporate, Partnership or LLP) to Bank or NBFC shall be covered under Reverse Charge.
- d. There are two recent circulars issued clarifying scope of transactions between principal and agent which clarifies the above aspects:
- i. Circular No.57/31/2018-GST dated September 4, 2018 (in the context of scope of principal-agent relationship). The entire jurisprudence under Indian Contract Act has been brought to bear in GST by making reference to section 182 and states as:
"Thus, the key ingredient for determining relationship under GST would be whether the invoice for the further supply of goods on behalf of the principal is being issued by the agent or not. Where the invoice for further supply is being issued by the agent in his name then, any provision of goods from the principal to the agent would fall within the fold of the said paragraph. However, it may be noted that in cases where the invoice is issued by the agent to the customer in the name of the principal, such agent shall not fall within the ambit of Schedule I of the CGST Act. Similarly, where the goods being procured by the agent on behalf of the principal are invoiced in the name of the agent then further provision of the said goods by the agent to the principal would be covered by the said paragraph. In other words, the crucial point is whether or not the agent has the authority to pass or receive the title of the goods on behalf of the principal"

There are various scenarios which are discussed to analysis and conclude the scope of this paragraph in Schedule I. Readers may refer to the above circular hosted on www.cbic.gov.in to understand those scenarios.

- ii. Circular No.73/47/2018-GST dated November 5, 2018 (in the context of del-credere agent) states as:

Sl No.	Issue	Clarification
1	Whether a DCA falls under the ambit of agent under Para 3 of Schedule I of the CGST Act?	As already clarified vide circular No. 57/31/2018-GST dated 4th September, 2018, whether or not the DCA will fall under the ambit of agent under Para 3 of Schedule I of the CGST Act depends on the following possible scenarios: for supply of goods is issued by the supplier to the customer, either himself or through DCA, the DCA does not fall under the ambit of agent. where the invoice for supply of goods is issued by the DCA in his own name, the DCA would fall under the ambit of agent.
2	Whether the temporary short-term transaction-based loan extended by the DCA to the recipient (buyer), for which interest is charged by the DCA, is to be included in the value of goods being supplied by the supplier (principal) where DCA is not an agent under Para 3 of Schedule I of the CGST Act?	In such a scenario following activities are taking place: 1. Supply of goods from supplier (principal) to recipient; 2. Supply of agency services from DCA to the supplier or the recipient or both; 3. Supply of extension of loan services by the DCA to the recipient. It is clarified that in cases where the DCA is not an agent under Para 3 of Schedule I of the CGST Act, the temporary short-term transaction-based loan being provided by DCA to the buyer is a supply of service by the

		<p><i>DCA to the recipient on Principal to Principal basis and is an independent supply.</i></p> <p><i>Therefore, the interest being charged by the DCA would not form part of the value of supply of goods supplied (to the buyer) by the supplier. It may be noted that vide notification No. 12/2017-Central Tax (Rate) dated 28th June 2017 (S. No. 27), services by way of extending deposits, loans or advances in so far as the consideration is represented by way of interest or discount (other than interest involved in credit card services) has been exempted.</i></p>
3	<p><i>Where DCA is an agent under Para 3 of Schedule I of the CGST Act and makes payment to the principal on behalf of the buyer and charges interest to the buyer for delayed payment along with the value of goods being supplied, whether the interest will form a part of the value of supply of goods also or not?</i></p>	<p><i>In such a scenario following activities are taking place: 1. Supply of goods by the supplier (principal) to the DCA; 2. Further supply of goods by the DCA to the recipient; 3. Supply of agency services by the DCA to the supplier or the recipient or both; 4. Extension of credit by the DCA to the recipient.</i></p> <p><i>It is clarified that in cases where the DCA is an agent under Para 3 of Schedule I of the CGST Act, the temporary short-term transaction-based credit being provided by DCA to the buyer no longer retains its character of an independent supply and is subsumed in the supply of the goods by the DCA to the recipient. It is emphasised that the activity of extension of credit by the DCA to the recipient would not be considered as a separate supply as it is in the context of the supply of goods made by the DCA to the recipient.</i></p> <p><i>It is further clarified that the value of</i></p>

		<i>the interest charged for such credit would be required to be included in the value of supply of goods by DCA to the recipient as per clause (d) of sub-section (2) of section 15 of the CGST Act.</i>
--	--	--

4. Import of services by a taxable person from a related person or from any of his other establishments outside India, in the course or furtherance of business.

- a. The expression 'import of service' has been defined to bear an innate requirement of an outflow of foreign convertible currency, and therefore, excludes any form of importation of services without consideration. Therefore, this clause is inserted to encompass such of those services, that are received from related persons / their establishments outside India. It is important for one to refer to Explanation 1 to Section 8 of the IGST Act, 2017 which deems any establishment outside India as an establishment of a distinct person. By virtue of this treatment, all services received by a taxable person in India from its branches / establishments located outside India would be considered to be a supply, even when made without consideration.
- b. For instance, say A Ltd is a holding company in USA and B Ltd a subsidiary in India. Many business operations are centralized in the USA such as accounting, ERP and other software, servers for the backup, legal function, etc. For the purpose of this clause, the back-end support provided by the holding company to the subsidiary company in India shall be regarded as a supply, whether or not there is a cross charge, even if the same is not recognised in the books, or any contracts, since it is categorized as an import of service by a taxable person from a related person without consideration, in the course of business.

(e) Activities to be treated as supply of goods or supply of services:

It is important to understand as to what constitutes a transaction of supply of goods or a transaction of supply of service. Section 7(1A) creates a fiction under the statute and specifies 'what is' and 'what is not' to be treated as a transaction of supply of goods or a transaction of supply of service. So understood, one can list out 18 classes of transactions enlisted Schedule II of which 5 classes of transactions are listed out as supply of goods while 13 others would tantamount to supply of services. On a careful consideration of the relevant clauses, it can be noticed that all the 6 classes of transactions listed out in Article 366(29A) of the Constitution of India are covered within the scope and ambit of Schedule II. While 2 transactions, out of the 6, are treated as supply of goods, the other 4 are deemed to be supply of services.

Importantly, paragraph 6 (a) relating to works contracts (as defined in Section 2(119)) is treated as a composite supply, of services. However, Section 2(119) has 14 distinct words, all of which are required to be read in conjunction with the words “immovable property”. Contracts relating to construction of immovable property are specifically covered in paragraph 5(b) of Schedule II. Therefore, all works contracts other than those relating to construction of immovable property would amount to composite supply in terms of Section 2(30) read with Section 8.

It is important for one to understand that **what is** specified/listed in Schedule II not only provides clarity but also **what has to be** treated as supply of goods or supply of services. Transactions listed out in schedule II enlarges the scope of supply as defined under Section 7(1) of the Act. Clause (d) of sub section (1) to Section 7 is part and parcel of definition of ‘supply’, thereby bringing within its scope and ambit, such of those activities that are not covered under the other clauses of sub section (1) to section 7. It would be interesting to note that certain paragraphs in Schedule II specifies the requirement of “consideration” whereas several others do not. In such a situation, it is important to understand the intent of the legislature. For example, Para 5(a) of Schedule II reads “renting of immovable property”. In this situation, how does one understand the taxability of the transaction where consideration is not involved? The only way to understand this lacuna is that such transactions that lack consideration would be relegated to valuation principles, but, importantly, the transaction would be treated as a supply.

The activities pertaining to this clause are listed in Schedule II to the Act, and discussed in the following paragraphs.

Entry in Schedule II	Analysis
1. Transfer	
a. <i>Any transfer of the title in goods is a supply of goods;</i>	This would be a clear case of a transfer of goods. It may be noted that this paragraph covers even a plain vanilla transfer of title in goods, either by way of sale or otherwise. Accordingly, where any goods are gifted to any person, say a motor car gifted by a businessman to his successor would be a supply of goods, provided there is a transfer of “title in” such goods. In legal parlance the phrase “title in” and “title to” have different connotations.
b. <i>Any transfer of right in goods or of undivided share in goods without the transfer of title thereof, is a supply of services;</i>	This paragraph can be construed to be a case of a temporary transfer whereas a transfer of title in goods would be a sale simpliciter. One must pay attention to the language employed in this paragraph which speaks of transfer of right and not transfer of title. Even though the activity is categorized as a supply of

Entry in Schedule II	Analysis
	<p>service, the rate of tax applicable on the supply has been linked to the rate of tax as applicable to the supply of same goods involving transfer of title in goods. Hence, for all practical purposes to determine the rate of tax on such services, all notifications in respect of that particular goods would merit equal consideration to determine the rate of tax for the service.</p> <p>Refer the entries for Heading 9971 and 9973 to the Notification 11/2017 dt. 28.06.2017 prescribing the rate of tax on services, as amended from time to time.</p> <p>Illustration: Notification 37/2017 Central Tax (Rate) dated 13.10.2017 was issued to reduce the rate of tax on motor vehicle to 65% of the tax rate as applicable with certain conditions. Considering the rate of tax for leasing of such motor vehicle to be same as that of the rate of tax as applicable on the motor vehicle, even the rate of tax on leasing services stands reduced if the conditions specified in the notification are met.</p>
<p><i>c. Any transfer of title in goods under an agreement which stipulates that property in goods shall pass at a future date upon payment of full consideration as agreed, is a supply of goods.</i></p>	<p>Any instalment sale or hire purchase transaction with a precondition that the possession is transferred on day one but the ownership is subject to payment of full consideration/ all instalments, would get categorized as a supply of goods at the time of transfer of possession. However, where the transaction is to be valued at the open market value, due care needs to be exercised so as to determine the value of instalments as against the value of the goods being transferred. One may also note that transactions of movables that could get covered under BOOT, BOLT, BOT etc., may also get covered under this paragraph.</p> <p>An important point which requires due consideration is the interest component in the hire purchase agreement. In this regard it is worth to mention that vide Notification No.12/2017-CGST (Rate) dated.28.06.2017 interest is stated to be exempt. However, only interest component is exempt. Therefore, if interest is separately mentioned then GST is not payable, however, if the interest amount is</p>

Entry in Schedule II	Analysis
	not separately mentioned than GST is payable on entire amount including interest.
2. Land and Building	
<p>a. <i>Any lease, tenancy, easement, licence to occupy land is a supply of services;</i></p>	<p>While a transfer (sale) of land is outside the scope of GST laws, the law seeks to tax certain other transfers pertaining to land, by way of this paragraph. Notification No. 4/2018 Central Tax (Rate) dated 25.01.2018 warrants attention in this regard. One issue which clearly emerges from the notification is that in case of a joint development agreement (JDA), the activity of providing the right to construct on a land belonging to the owner, is an independent supply in the hands of the owner and that supply, is treated as a supply of service in terms of this clause. It is inferred that such a service is independent of the construction service which the developer provides to the land owner. The challenge that arises would relate to the valuation for both these supplies. It is important to note that such transactions are vivi-sected for the purposes of levy of tax and have not been construed as a single demise.</p>
<p>b. <i>Any lease or letting out of the building including a commercial, industrial or residential complex for business or commerce, either wholly or partly, is a supply of services.</i></p>	<p>The activity of leasing or letting out of complexes for the purpose of business or commerce is covered under this clause, and not those used for the purpose of residence. It may be noted that the services by way of renting of residential dwelling for use as residence is exempt vide Notification No.12/2017 – Central tax (Rate) dated 28.06.2017. While on the subject, it is pertinent to note the distinction between a transaction of rent, lease and a transaction of “letting out”. A transaction of rent is what is lawfully payable by a tenant, a transaction of lease is an alienation or conveyance for the purpose of enjoyment whether or not for a specified period. The word ‘Let’ is to be understood as a verb meaning allow, permit, grant or hire.</p>
3. Treatment or process	
<p><i>Any treatment or process which is applied to another</i></p>	<p>While this transaction may not be <i>pari materia</i> with a works contract the activity which could get categorized</p>

Entry in Schedule II	Analysis
<i>person's goods is a supply of services.</i>	<p>under this clause it appears would be “job work” as defined under Section 2(68) of the Act.</p> <p>The only difference between the definition clause in terms of section 2(68) and this paragraph - is that the activity would be regarded as a job work only if carried out for a registered principal. However, regardless of the registration of the principal, the activity would be categorized as service under this clause.</p> <p>Certain clarifications have been provided vide Circular No.38/12/2018 dated 26.03.2018 on job work which would be relevant and can make a useful read.</p>
4. Transfer of business assets	
<p>a. <i>Where goods forming part of the assets of a business are transferred or disposed of by or under the directions of the person carrying on the business so as no longer to form part of those assets, whether or not for a consideration, such transfer or disposal is a supply of goods by the person;</i></p>	<p>This clause provides for taxability of such of those transactions where business assets stand transferred. Typically, assets donated could be an example of such a transaction. One must pay attention to the fact that this clause abstains from the usage of the expression “in the course or furtherance of business” or “consideration”. Thus, it is possible to infer that all such transactions which escape the attention of Section 7(1) (a) or 7(1) (c), are covered under this clause, so as to be treated as supply of goods.</p> <p>Random thought: A permanent transfer of business asset on which no ITC had been availed may be regarded as a supply of goods under this clause. However, since there exists a competing paragraph 1 of schedule 1, being the paragraph more specific would stand attracted. Courts alone can settle this understanding.</p>
<p>b. <i>Where, by or under the direction of a person carrying on a business, goods held or used for the purposes of the business are put to any private use or are used, or made available to any person for use, for any purpose other than a purpose of the business,</i></p>	<p>Any part of the business assets if put to use for private purpose of any purpose other than for business, then such usage is termed as supply of services under this clause. Therefore, where the law deems this activity as a supply and subjects the same to tax, it can be contended that there would be no requirement to reverse the input tax credit availed on the goods although the same is put to non-business use, on the premise that the activity is considered to be a taxable outward supply and subjected to tax.</p>

Entry in Schedule II	Analysis
<p><i>whether or not for a consideration, the usage or making available of such goods is a supply of services;</i></p>	<p>Normally, the words “private” and “personal” are used inter-changeably. But the legal connotation is that private is “non official concerning one or more individuals” while ‘personal’ does not relate to a business scenario. For example: Audio-visual equipment owned by a business can be put to private use by a group of individuals or by an individual for his or her use.</p> <p>One must exercise caution while determining what amounts to private use / non-business use, since this will have a direct bearing on the deductions claimed under the Income tax law.</p> <p>In this regard, it may be noted that a service by way of transfer of a going concern, as a whole or an independent part thereof, is an exempted service in terms of Notification 12/2017-Central Tax (Rate) dated 28.06.2017 as amended from time to time.</p>
<p>c. where any person ceases to be a taxable person, any goods forming part of the assets of any business carried on by him shall be deemed to be supplied by him in the course or furtherance of his business immediately before he ceases to be a taxable person, unless—</p> <p>i. the business is transferred as a going concern to another person; or</p> <p>ii. the business is carried on by a personal representative who is deemed to be a taxable person.</p>	<p>The supply under this clause can be understood to be a supply of goods, although the paragraph does not explicitly specify so.</p> <p>Attention is drawn to Section 29(5) of the Act dealing with “Cancellation of Registration”, wherein the law provides that the person applying for cancellation of registration is required to pay an amount equivalent to the credit of input tax or the output tax payable thereon, in respect of inputs held in stock and inputs contained in semi-finished or finished goods held in stock or capital goods or plant and machinery on the day immediately preceding the date of such cancellation, whichever is higher.</p> <p>It is important to understand the subtle usage of the expression “ceases to be a taxable person”. Cessation of being a taxable person could result from either closure of business, voluntarily or otherwise, while the clause also speaks of transfer of business in the latter part. One can reasonably infer that in terms of this clause if a business is transferred on a lock, stock and barrel basis as a going concern then such transactions cannot be subjected to tax; even in</p>

Entry in Schedule II	Analysis
	<p>situations where the transfer of business takes place and a representative (acting as a taxable person) carries on such business, the question of subjecting such a transaction to tax, as a cessation of business does not arise.</p> <p>AAR, Karnataka vs. Rajashri Foods (P.) Ltd.- Whether transfer of a going concern means transfer of a running business which is capable of being carried on by purchaser as an independent business - Held, yes - Whether where applicant had not furnished any documentary evidence to establish that applicant is a going concern except their admission that its an ongoing business and transaction proposes to transfer all assets and liabilities to new owner, it implies that business will continue in new hands with regularity and nature of permanency - Held, yes - Whether thus transaction of transfer of business as a going concern amounts to supply of service and it is exempt from payment of tax under GST subject to condition that unit is a going concern - Held, yes</p>
<p>5. Supply of services: The following shall be treated as supply of service, namely: —</p>	
<p>a. renting of immovable property;</p>	<p>Renting wholly or partly of any immovable property is treated as a service. Therefore, unless the supply is otherwise exempted (such as renting of residential dwelling for the purpose of residence), the activity shall be regarded as a supply.</p>
<p>b. <i>Construction of a complex, building, civil structure or a part thereof, including a complex or building intended for sale to a buyer, wholly or partly, except where the entire consideration has been received after issuance of completion certificate, where required, by the competent authority or after</i></p>	<p>Schedule III of the Act at SI No.5 reads “sale of land and, subject to clause b of paragraph 5 of schedule II, sale of building. We need to pay attention as to how this clause is to be read and understood. Let us now read the clause as follows:</p> <ul style="list-style-type: none"> ✓ Sale of land; ✓ Sale of building; ✓ Sale of land and sale of building; ✓ Sale of land and building in which an undivided share in land stands transferred. <p>It must be noted with caution, that paragraph 5 of</p>

Entry in Schedule II	Analysis
<i>its first occupation, whichever is earlier.</i>	<p>schedule III is 'subject to clause b of paragraph 5 of schedule II'. It means that, clause b of paragraph 5 of schedule II overrides the paragraph 5 to schedule III. It is for this reason that development contracts in the real estate sector have been a subject matter of tax in terms of paragraph 5(b) of the second schedule.</p> <p>Any agreement for sale of an immovable property (being in the nature of transfer of UDI in land plus building or in case of revenue share agreements which equally stipulates transfer of UDI in land plus constructed part) would be subject to tax as a service. In this backdrop, it is important to note that some experts are of the view, that the legislature intends to overcome the constitutional bench decision of the Supreme Court in the Larsen & Toubro's case (65 VST 1). So understood, any part of the consideration if received, prior to obtaining completion certificate or first occupation in a building would stand to be taxed while all transactions entered into thereafter, would be construed as a sale of immovable property.</p>
<i>c. Temporary transfer or permitting the use or enjoyment of any intellectual property right;</i>	<p>The words 'or' in this clause is to be understood as a disjunctive particle that carves out alternatives. So understood, this clause envisages three separate classes of transactions which could be read as follows:</p> <ul style="list-style-type: none"> ✓ Temporary transfer of any IPR; ✓ Permitting the use of any IPR; ✓ Permitting the use or enjoyment of any IPR. <p>In respect of temporary transfer or usage of IPRs one needs to travel to the relevant notification to understand their import. The scheme of classification of services for the heading 9973 provides for temporary as well as permanent transfer of IPR in respect of goods.</p> <p>However, with effect from 15.11.2017, the rate notification for goods has also incorporated an paragraph for the permanent transfer of IPR in respect of goods and there has been no corresponding</p>

Entry in Schedule II	Analysis
	<p>deletion of the words “or permanent” in the rate notification for services.</p> <p>Due care needs to be exercised by the registered person in order to determine whether supply is of goods or services.</p>
<p>d. <i>Development, design, programming, customisation, adaptation, upgradation, enhancement, implementation of information technology software;</i></p>	<p>The dichotomy which prevailed in the erstwhile service tax and VAT regime (i.e., the question of whether software should suffer service tax or VAT or both) has been put to rest under GST.</p> <p>While this paragraph takes care of certain activities in respect of IT software, it must be noted that the supply of pre-developed or pre-designed software in any medium/storage (commonly bought off-the-shelf), or making available of software through the use of encryption keys, is treated as a supply of goods, classifiable under heading 8523.</p>
<p>e. <i>Agreeing to the obligation to refrain from an act, or to tolerate an act or a situation, or to do an act;</i></p>	<p>Some examples that may get covered under this clause are as under:</p> <ul style="list-style-type: none"> • Non-compete agreement for a fee; • Notice period recovery; • Additional amount agreed upon for settlement of any dispute/matter etc. • Look at a situation where a supplier would supply product ‘A’ only if the recipient agrees to buy product ‘B’- readers can think as to whether such transactions would amount to supply of goods or supply of services?; <p>Reference may be made to Maharashtra AAR decision in the case of Maharashtra State Power Generation Company Limited, ruling liquidated damages as supplies under GST.</p>
<p>f. <i>Transfer of the right to use any goods for any purpose (whether or not for a specified period) for cash, deferred payment or other valuable consideration.</i></p>	<p>Transfer of ‘right to use goods’ is treated as a supply of service and taxed at par, with the rate of tax as applicable to the goods involved in the transaction. (Refer discussion under clause 1(a) of Schedule II).</p>

Entry in Schedule II	Analysis
6. Composite supply: The following composite supplies shall be treated as a supply of services, namely: —	
<p>a. <i>Works contract as defined in clause (119) of section 2;</i></p>	<p>Our understanding of works contract under the erstwhile VAT / sales tax / service tax laws has no relevance in the GST regime. In the GST regime, only such of those contract that results in an immovable property is a 'works contract'. Every other contract which was understood to be a 'works contract' under the erstwhile laws will be treated as a composite / mixed supply under the Act. In such cases, the transaction may be treated as goods or services, based on the principles laid down in Section 8 (discussed separately in this Chapter).</p>
<p>b. <i>Supply, by way of or as part of any service or in any other manner whatsoever, of goods, being food or any other article for human consumption or any drink (other than alcoholic liquor for human consumption), where such supply or service is for cash, deferred payment or other valuable consideration.</i></p>	<p>The Law categorises the supplies referred to in this clause as a composite supply, given that there are multiple goods and/or services which are essentially involved in such a transaction culminating into a composite supply of service.</p> <p>Under this clause both restaurant and outdoor catering services get covered. It may also be contended that the clause also covers other forms such as parcels, take-away, home-delivery, etc.</p> <p>Irrespective of the rate of tax as applicable on independent goods or services that are being supplied, the rate of tax as applicable to a restaurant service or outdoor catering service would be applicable to the goods being supplied. E.g.: Aerated drink which is served in a restaurant would be subject to tax at the rate applicable to the entire supply (restaurant service) regardless of the fact that aerated drinks are otherwise subjected to a higher rate of tax as well as cess. By this logic, some experts argue that tobacco products which are sold in a restaurant and billed along with the supply of food/beverage must also be taxed at the rate as applicable to restaurant services - as a composite supply. The test that one needs to apply in the given situation is find out as to whether tobacco products are "food" or "an article for</p>

Entry in Schedule II	Analysis
	<p>human consumption". A plain reading would imply that tobacco products are certainly not "food". However, the phrase "any other article for human consumption" must be construed in a sense as to how a common man would understand. Meaning, the test of common parlance must be applied. So understood, in plain and simple terms tobacco products cannot get classified under this clause.</p> <p>This paragraph is not purely for restaurants / outdoor caterers, and is applicable to any person who is engaged in the supply of food / beverages. It may be noted that there is no requirement that such a supply is in the course or furtherance of business. It would be sufficient if the supply is for a consideration. Circular No.28/02/2018 dated 08.01.2018 has provided clarifications regarding GST on college hostel / mess which reads:</p> <p><i>"It is immaterial whether the service is provided by the educational institution itself or the institution outsources the activity to an outside contractor"</i>.</p> <p>STATUTORY UPDATE: - Circular No.28/2/2018-GST dated 08.01.2018 was issued providing clarification that the educational institutions which have mess facility for providing food to their students and staff. Such facility is either run by the institution/students themselves or is outsourced to third person. Supply of food or drink provided by a mess or canteen is taxable at 5% without ITC.</p>
<p>7. Supply of Goods: The following shall be treated as supply of goods, namely: —</p>	
<p><i>Supply of goods by any unincorporated association or body of persons to a member thereof for cash, deferred payment or other valuable consideration</i></p>	<p>The definition of the term 'business' under Section 2(17) includes "provision by a club, association, society, or any such body (for a subscription or any other consideration) of the facilities or benefits to its members;" In order to clarify that the supply of goods by such association etc., to its members is to be treated as a supply of goods and not as a service of providing facilities, this clause has been included.</p>

- (f) **Certain supplies will be neither a supply of goods, nor a supply of services:** The law lists down matters which shall not be considered as 'supply' for GST by way of Schedule III. Since these are transactions that are not regarded as 'supply' under the GST Laws, there is no requirement to report the inward / outward supply of such activities in the returns.

Activities listed in Schedule III	Analysis
Services by an employee to the employer in the course of or in relation to his employment.	The paragraph includes only services and not goods. Further, the paragraph only covers those services provided by an employee to the employer and not vice versa. Therefore, services such as serving of beverages in the office may possibly be regarded as a supply of service under Entry 2 of Schedule I.
Services by any Court or Tribunal established under any law for the time being in force; The term "court" includes District Court, High Court and Supreme Court.	The word tribunal does not cover Arbitral Tribunal in itself. Since the tribunal is dissolved after the adjudication proceedings are concluded.
Functions performed by MPs, MLAs, etc.; the duties performed by a person who holds any post in pursuance of the provisions of the Constitution in that capacity; the duties performed by specified persons in a body established by the Central State Government or local authority, not deemed as an employee;	Persons included in this clause may be Governor, Prime Minister, President etc.
Services of funeral, burial, crematorium or mortuary including transportation of the deceased.	This clause is consonance with the exemption available in the erstwhile service tax regime.
Sale of land and, subject to clause (b) of paragraph 5 of Schedule II, sale of building (i.e., excluding sale of under-construction premises where the part or full consideration is received before issuance of completion certificate or before its first occupation, whichever is	It is intriguing as to why two activities being (i) sale of land and (ii) sale of building, have been clubbed into a single paragraph. However, one may expand the paragraph to read the two activities as distinct activities, so as to treat a sale of land without the sale of building, also to be outside the purview

Activities listed in Schedule III	Analysis
earlier);	of GST. Refer to discussions schedule II paragraph 5(b) supra.
Actionable claims, other than lottery, betting and gambling	<p>A plain reading of this paragraph would mean that actionable claims are neither a supply of goods nor a supply of services. However, the three classes of actionable claims listed in this paragraph warrant attention.</p> <p>The definition of the word 'goods' includes the words 'actionable claims'. It has to therefore, be necessarily understood that the three classes of actionable claims viz. lottery, betting and gambling, if and when subjected to tax, must be taxed as goods. The irony is, while lottery is subject to tax as goods, betting and gambling have been subjected to tax as services under the heading 9996.</p> <p>It appears that this <i>faux pas</i> can be set-right only through a legislative amendment.</p>
Supply of goods from a place in the non-taxable territory to another place in the non-taxable territory without such goods entering into India.	This insertion w.e.f. 1 st February 2019 lays to rest the confusion which had arisen on such transactions and steers it clear, outside the applicability of GST. Therefore, any transaction involving supply of goods by a person in India would not be called a supply if such goods are supplied from one place to another, both of which are outside India.
<p>Supply of warehoused goods to any person before clearance for home consumption;</p> <p>Supply of goods by the consignee to any other person, by endorsement of</p>	The levy of the IGST on import of goods would be levied under the Customs Act, 1962 read with the Custom Tariff Act, 1975. IGST is payable when the goods are cleared for home consumption,

Activities listed in Schedule III	Analysis
documents of title to the goods, after the goods have been dispatched from the port of origin located outside India but before clearance for home consumption.	<p>however high sea sales were considered akin to inter-state transactions.</p> <p>Even though Circular No. 33 /2017-Cus, dated 1st August, 2017 clarified this matter that IGST on high sea sale, shall be levied and collected only at the time of importation i.e. when the import declarations are filed before the Customs authorities for the customs clearance purposes for the first time. However, the point of reversal of ITC was always contentious and various advance rulings, ruled in favour of revenue, further added on to it.</p> <p>Now post insertion of this entry in schedule III, being activities or transactions, which shall be treated neither as a supply of goods nor a supply of services, the reversal of ITC would not be required, as this transaction now goes outside the scope of supply.</p>

(g) **To be notified:** The Government has vested itself powers to notify 'activities or other transactions' which shall neither be treated as supply of goods nor a supply of services in terms of section 7(2). Such notification would be issued from time to time based on the recommendations of the GST Council.

- The Government has notified the following supplies in this regard:
Services by way of any activity in relation to a function entrusted to Panchayat under Article 243G of the Constitution
(Inserted vide Notification No. 14/2017- Central Tax (Rate) dated 28.06.2017)
- The inter-State movement of goods like movement of various modes of conveyance, between 'distinct persons' as explained in this Chapter, including trains, buses, trucks, tankers, trailers, vessels, containers & aircrafts, carrying goods or passengers or both, or for repairs and maintenance, would also not be regarded as supplies except in cases where such movement is for further supply of

the same conveyance (Clarified vide *Circular No. 1/1/2017-IGST dated 07.07.2017*).

- The above logic would apply to the issue pertaining to inter-State movement of jigs, tools and spares, and all goods on wheels like cranes, except in cases where movement of such goods is for further supply of the same goods, and consequently no IGST would be applicable on such movements (Clarified vide *Circular No. 21/21/2017-GST dated 22.11.2017*).
- (h) The Government is also empowered to specify what shall be treated as a supply of goods / services, as is the function of Schedule II, based on the recommendation of the GST Council, by specifying that a supply is to be treated as:
- i) A supply of goods and not a supply of service;
 - ii) A supply of service and not a supply of goods.
- (i) In summary, supply can be understood as follows:

Section	Specified 'forms' of supply	Furtherance of Business	Existence of Consideration	Supply	
				'made'	'agreed to be made'
7(1)(a)	✓	✓	✓	✓	✓
7(1)(b)	✓	✓/x	✓	✓	x
7(1)(c)	✓	✓	✓/x	✓	x

- (j) The GST Law also treats certain transactions to be supplies by way of a deeming fiction imposed in the statute.
- (a) The law expressly uses the phrase 'deemed supply' in Section 19(3) and 19(6) in respect of inputs/capital goods sent to a job worker but are not returned within the time period of 1 year/ 3 years permitted for their return.
 - (b) The bill-to-ship-to transactions wherein the supply is deemed to have been made to the person to whom the invoice is issued, imposes an intrinsic condition that such person who receives the invoice should in turn issue an invoice to the recipient unless the transaction demands a treatment otherwise. For instance, where an order is placed on a vendor based on an order received from a customer, the registered person may request the vendor to directly ship the goods to the customer. In this case, although there is a single movement of goods, there is a dual change of title to goods, and therefore, there would be 2 supplies. However, the other limb of the transaction would get independently tested for supply under Section 7.

Statutory Provisions**8. Tax liability on composite and mixed supplies**

The tax liability on a composite or a mixed supply shall be determined in the following manner, namely: —

- (a) a composite supply comprising two or more supplies, one of which is a principal supply, shall be treated as a supply of such principal supply; and*
- (b) a mixed supply comprising two or more supplies shall be treated as a supply of that particular supply which attracts the highest rate of tax.*

Relevant circulars, notifications, clarifications issued by Government

1. Circular No. 34/8/2018 dated 01.03.2018 clarifying on the taxability of certain services;
2. Circular No. 13/13/2017 dated 27.10.2017 regarding unstitched salwar suits;
3. Circular No. 11/11/2017 dated 20.10.2017 regarding taxability of printing contracts;
4. Chapter four of the compilation of the GST Flyers as issued by the CBIT can be referred to for a gist of the statutory provisions, titled '*Composite Supply and Mixed Supply*'.

Related provisions of the Statute

Section or Rule	Description
Section 2(30)	Definition of Composite Supply
Section 2(90)	Definition of Principal Supply
Section 2(74)	Definition of Mixed Supply
Schedule II	Activities to be treated as a supply of goods or a supply of services

8.1. Introduction

Every supply should involve either goods, or services, or a combination of goods or a combination of services, or a combination of both. The law provides that such supplies would be classifiable for the purpose of tax treatment, either as wholly goods or wholly services, in the case of all such combinations. Schedule II of the Act provides for this classification in some of the listed instances thereunder.

8.2. Analysis

Where a supply involves multiple (more than one) goods or services, or a combination of goods and services, the treatment of such supplies would be as follows:

- (a) If it involves more than one goods and / or services which are naturally bundled together and supplied in conjunction with each other in the ordinary course of business and one such supply would be a principal supply:**

- (i) These are referred to as composite supply of goods and / or services. It shall be deemed to be a supply of those goods or services, which constitutes the principal supply therein. Only where all of the conditions specified for a supply of a combination of goods and/or services to be treated as a composite supply are satisfied, the supply can be regarded as a composite supply. The conditions are as follows:
1. The supply must be made **by a taxable person**: This condition presumes that composite supplies can only be effected by a taxable person.
 2. The supply must comprise 2 / more **taxable** supplies: The law merely specifies that the supplies included within a composite supply must contain 2 or more taxable supplies. A question may then arise as to what would be the treatment in case of a supply that fulfils all the conditions, but involves an exempt supply – say, purchase of fresh vegetables from a store which offers home delivery for an added charge. Fresh vegetables are exempt from tax, whereas the service of home delivery would attract tax. No clarification has been issued in this regard. However, on a plain reading of the provision, it appears that this condition would not be satisfied where the composite supply involves an exempt supply. One could argue that taxable supply includes exempt by virtue of the definition of taxable supply under Section 2(108).
 3. The goods and / or services involved in the supply must be **naturally bundled**: The concept of natural bundling needs to be examined on a case to case basis. What is naturally bundled in one set-up may not be regarded as naturally bundled in another situation. For instance, stay with breakfast is naturally bundled in the hotel industry, while the supply of lunch and dinner, even if they form part of the same invoice, may not be considered as naturally bundled supplies along with room rent.
 4. They must be supplied in conjunction with each other in the **ordinary course of business**: Where certain supplies could be naturally bundled, it is essential that they are so supplied in the ordinary course of business of the taxable person. For instance, it is possible to consider the supply of a water purifier along with the first-time installation service as a naturally bundled supply. However, if a supplier of water purifiers does not ordinarily provide the installation service, and arranges for a person to provide the installation service in the case of an important business customer, the supply would not satisfy the said condition.
 5. Only one of the supplies involved must qualify as the **principal supply**: In every composite supply, there must be only one principal supply. Where a conflict between the various components of the supply, as to which of those qualify as the principal supply, cannot be resolved and results in multiple predominant supplies, the supply cannot be regarded as a composite supply.

- (a) A principal supply is defined u/s 2(90) to mean the predominant element of a composite supply to which any other supply forming part of that composite supply is ancillary.
- (b) Therefore, mere identification of the predominant element would not suffice, and it must be ascertained that all other supplies composed in the composite supply are ancillary to that predominant element of the supply.
- (c) Consider the case of a supply of dining table with chairs. There would normally be no issue in this regard if both the components are made of the same material. However, if the dining table is made of granite, while the chairs are made of superior quality wood, there would be a conflict. Normally, the dining table would be regarded as the principal supply to which the supply of chairs is ancillary. However, in this case, it may not be possible to determine which of the two make the principal supply.

Where any of the aforesaid conditions are not satisfied, the transaction cannot be treated as a composite supply.

- (ii) The matters such as time of supply, invoicing, place of supply, value of supply, rate of tax applicable to the supply, etc. shall all be determined in respect of the principal supply alone, since the entire supply shall be deemed to be a supply of the principal supply alone.
- (iii) Some Illustrations and cases of composite supplies have been discussed in the following paragraphs:
 - ✓ *Illustration (provided in Section 2(27))*: Where goods are packed, and transported with insurance, the supply of goods, packing materials, transport and insurance is a composite supply and supply of goods is the principal supply. This implies that the supply will be taxed wholly as supply of goods.
 - ✓ *Para 5(3) of Circular No.32/06/2018-GST dated 12.02.2018* clarifies that “food supplied to the in-patients as advised by the doctor/nutritionists is a **part of composite supply of health care** and not separately taxable”. It also goes on to clarify further that supplies of food by hospital to patients (not admitted) or their attendants or visitors are taxable.
 - ✓ *Circular No.11/11/2017-GST dated 20.10.2017* has provided clarification on treatment of printing contracts. It is clarified that:
 - ❖ In the case of printing of books, pamphlets, brochures, annual reports, and the like, where only content is supplied by the publisher or the person who owns the usage rights to the intangible inputs while the physical inputs including paper used for printing belong to the printer, supply of printing of the content supplied by the recipient of supply is the principal supply.

- ❖ In case of supply of printed envelopes, letter cards, printed boxes, tissues, napkins, wall paper etc. falling under Chapter 48 or 49, printed with design, logo etc. supplied by the recipient of goods but made using physical inputs including paper belonging to the printer, the predominant supply is that of goods and the supply of printing of the content supplied by the recipient of supply is ancillary to the principal supply of goods and therefore such supplies would constitute supply of goods falling under respective headings of Chapter 48 or 49 of the Customs Tariff.
 - ✓ Circular No. 34/8/2018-GST dated 01.03.2018 provides a clarification on some matters including the following:
 - ❖ The activity of bus body building is a composite supply. As regards which of the components is the principal supply, the Circular directs that it be determined on the basis of facts and circumstances of each case.
 - ✓ Re-treading of tyres– In re-treading of tyres, which is a composite supply, the pre-dominant element is the process of re-treading which is a supply of service, and the rubber used for re-treading is an ancillary supply. The Circular also specifies that *“Value may be one of the guiding factors in this determination, but not the sole factor. The primary question that should be asked is what is the essential nature of the composite supply and which element of the supply imparts that essential nature to the composite supply”*.
 - ✓ Other examples: If a contract is entered for (i) supply of certain goods and erection and installation of the same thereto or (ii) supply of certain goods along with installation and warranty thereto, it is important to note that these are naturally bundled and therefore would qualify as ‘composite supply’. Accordingly, it would *qualify* as supply of the goods therein, which is essentially the principal supply in the contract. Thus, the value attributable to erection and installation or installation and warranty thereto will also be taxable as if they are supply of the goods therein.
 - ✓ **ADVANCE RULING ON COMPOSITE SUPPLY:-** AAR, West Bengal vs. Switching Avo Electro Power Ltd.-“ *Whether if a combination of goods that does not amount to a composite supply is being offered at a single price, such supplies are to be treated as mixed supplies - Held, yes - Whether where UPS and battery are supplied as separate goods, but a single price is charged for combination of goods supplied as single contract, supply of UPS and battery is to be considered as mixed supply within meaning of section 2(74), as they are supplied under a single contract at a combined single price - Held, yes”*
- (b) **If it involves supply of more than one goods and / or services which are not naturally bundled together but sold for a single price:**
- (i) These are referred to as mixed supply of goods and / or services. It shall be deemed

to be a supply of that goods or services therein, which are liable to tax at the highest rate of GST. The characteristics of a mixed supply is as follows:

1. It involves 2 / more **individual supplies**: It may be noted that the term used in the case of mixed supply is “individual supplies” as against “taxable supplies”. Therefore, a mixed supply can include both taxable and non-taxable supplies
 2. It is made by a **taxable person**;
 3. The supply is made for a **single price**: The fact that a composite supply does not include this condition merits consideration. Where a supply of 2 / more goods or services is made for different prices, the supplies cannot be regarded as mixed supplies.
 4. The supply does **not constitute a composite supply**: The expression “constitute” has a large ambit to include cases where the supply results in a composite supply, as well as a case where some of the components together make a composite supply, whereas the bundle together would make a mixed supply. While the condition as such is not explicit, given that there is no provision for treatment of a bundled supply where only some components together qualify as a composite supply, it may be safe to interpret that a mixed supply is one which is not regarded as a composite supply.
- (ii) The matters such as time of supply, invoicing, place of supply, value of supply, rate of tax applicable to the supply, etc. shall all be determined in respect of that supply which attracts the highest rate of tax. However, the law remains silent on what is the treatment required to be undertaken where more than one component is subjected to the highest rate of tax. For instance, consider a case where a commercial complex is let out for a consideration of monthly rentals, and the owner of the complex also supplies parking lots to those tenants who opt for the facility. While both the supplies attract tax @ 18%, the law does not prescribe for treatment of the transaction as that of only one of the two supplies.
- (iii) Some Illustrations and cases of mixed supplies have been discussed in the following paragraphs:
- ✓ *Illustration (provided in Section 2(66))*: A supply of a package consisting of canned foods, sweets, chocolates, cakes, dry fruits, aerated drink and fruit juices when supplied for a single price is a mixed supply. Each of these items can be supplied separately and is not dependent on any other. It shall not be a mixed supply if these items are supplied separately. **This implies that the supply will be taxed wholly as supply of those goods which are liable to the highest rate of GST.**
 - ✓ Other examples: If a tooth paste (say for instance it is liable to GST at 12%) is bundled along with a tooth brush (say for instance it is liable to GST at 18%) and is sold as a single unit for a single price, it would be reckoned as a mixed

supply. This would therefore be liable to GST at 18% (higher of 12% or 18% applicable to each of the goods therein).

- (c) While there are no infallible tests for such determination, the following guiding principles could be adopted to determine whether a supply would be a composite supply or a mixed supply. However, every supply should be independently analysed.

Description	Composite Supply	Mixed Supply
Naturally bundled	Yes	No
Each supply available for supply individually	No	Yes / No
One is predominant supply for recipient	Yes	Yes / No
Other supply(ies) are ancillary or they are received because of predominant supply	Yes	No
Each supply priced separately	Yes / No	No
Supplied together	Yes	Yes
All supplies can be goods	Yes	Yes
All supplies can be services	Yes	Yes
A combination of one / more goods and one / more services	Yes	Yes

ADVANCE RULING ON COMPOSITE SUPPLY/MIXED SUPPLY

- **AAR, Haryana vs. Paras Motor Industries**-Whether activity of fabrication and fitting and mounting of bus bodies on chassis supplied by other party is a composite supply of service with supply of goods, i.e., bus bodies, being principal supply and same is covered under HSN Code 8707 - Held, yes
- **AAR, Kolkata vs. Switching Avo Electro Power Ltd.**- Whether if a combination of goods that does not amount to a composite supply is being offered at a single price, such supplies are to be treated as mixed supplies - Held, yes - Whether where UPS and battery are supplied as separate goods, but a single price is charged for combination of goods supplied as single contract, supply of UPS and battery is to be considered as mixed supply within meaning of section 2(74), as they are supplied under a single contract at a combined single price - Held, yes.

Statutory Provisions- Effective from 1st July, 2017 to 31st January, 2019

9. Levy and Collection

- (1) Subject to the provisions of sub-section (2), there shall be levied a tax called the central goods and services tax on all intra-State supplies of goods or services or both, except on the supply of alcoholic liquor for human consumption, on the value

determined under section 15 and at such rates, not exceeding twenty per cent., as may be notified by the Government on the recommendations of the Council and collected in such manner as may be prescribed and shall be paid by the taxable person.

- (2) The central tax on the supply of petroleum crude, high speed diesel, motor spirit (commonly known as petrol), natural gas and aviation turbine fuel shall be levied with effect from such date as may be notified by the Government on the recommendations of the Council.
- (3) The Government may, on the recommendations of the Council, by notification, specify categories of supply of goods or services or both, the tax on which shall be paid on reverse charge basis by the recipient of such goods or services or both and all the provisions of this Act shall apply to such recipient as if he is the person liable for paying the tax in relation to the supply of such goods or services or both
- (4) The central tax in respect of the supply of taxable goods or services or both by a supplier, who is not registered, to a registered person shall be paid by such person on reverse charge basis as the recipient and all the provisions of this Act shall apply to such recipient as if he is the person liable for paying the tax in relation to the supply of such goods or services or both.
- (5) The Government may, on the recommendations of the Council, by notification, specify categories of services the tax on intra-State supplies of which shall be paid by the electronic commerce operator if such services are supplied through it, and all the provisions of this Act shall apply to such electronic commerce operator as if he is the supplier liable for paying the tax in relation to the supply of such services:

Provided that where an electronic commerce operator does not have a physical presence in the taxable territory, any person representing such electronic commerce operator for any purpose in the taxable territory shall be liable to pay tax:

Provided further that where an electronic commerce operator does not have a physical presence in the taxable territory and also, he does not have a representative in the said territory, such electronic commerce operator shall appoint a person in the taxable territory for the purpose of paying tax and such person shall be liable to pay tax.

Statutory Provisions- Effective from 1st February 2019 vide The Central Goods & Services Tax Amendment Act,2018

9. Levy and Collection

- (1) *Subject to the provisions of sub-section (2), there shall be levied a tax called the central goods and services tax on all intra-State supplies of goods or services or both, except on the supply of alcoholic liquor for human consumption, on the value determined*

undersection 15 and at such rates, not exceeding twenty per cent., as may be notified by the Government on the recommendations of the Council and collected in such manner as may be prescribed and shall be paid by the taxable person.

- (2) *The central tax on the supply of petroleum crude, high speed diesel, motor spirit (commonly known as petrol), natural gas and aviation turbine fuel shall be levied with effect from such date as may be notified by the Government on the recommendations of the Council.*
- (3) *The Government may, on the recommendations of the Council, by notification, specify categories of supply of goods or services or both, the tax on which shall be paid on reverse charge basis by the recipient of such goods or services or both and all the provisions of this Act shall apply to such recipient as if he is the person liable for paying the tax in relation to the supply of such goods or services or both*
- (4) *The Government may, on the recommendations of the Council, by notification, specify a class of registered persons who shall, in respect of supply of specified categories of goods or services or both received from an unregistered supplier, pay the tax on reverse charge basis as the recipient of such supply of goods or services or both, and all the provisions of this Act shall apply to such recipient as if he is the person liable for paying the tax in relation to such supply of goods or services or both.*
- (5) *The Government may, on the recommendations of the Council, by notification, specify categories of services the tax on intra-State supplies of which shall be paid by the electronic commerce operator if such services are supplied through it, and all the provisions of this Act shall apply to such electronic commerce operator as if he is the supplier liable for paying the tax in relation to the supply of such services:*

Provided that where an electronic commerce operator does not have a physical presence in the taxable territory, any person representing such electronic commerce operator for any purpose in the taxable territory shall be liable to pay tax:

Provided further that where an electronic commerce operator does not have a physical presence in the taxable territory and also, he does not have a representative in the said territory, such electronic commerce operator shall appoint a person in the taxable territory for the purpose of paying tax and such person shall be liable to pay tax.

Relevant circulars, notifications, clarifications issued by Government

1. All rate notifications issued under the law from time to time;
2. Circular No. 44/18/2018 dated 02.05.2018 clarifying on the taxability of tenancy rights;
3. Circular No. 35/9/2018 dated 05.03.2018 clarifying on the taxability of services provided by member of JV to JV;
4. Circular No. 34/8/2018 dated 01.03.2018 clarifying on the taxability of certain services;

5. Circular No. 32/06/2018 dated 12.02.2018 clarifying on the taxability of certain services;
6. Circular No. 30/4/2018 dated 25.01.2018 regarding supplies made to the Indian Railways classifiable under any chapter other than Chapter 86;
7. Circular No. 29/3/2018 dated 25.01.2018 regarding applicability of GST on Polybutylene feedstock and Liquefied Petroleum Gas retained for the manufacture of Poly Iso Butylene and Propylene or Di-butyl paragraph Cresol;
8. Circular No. 28/02/2018 dated 08.01.2018 regarding GST on College Hostel Mess Fees;
9. Circular No. 27/01/2018 dated 04.01.2018 regarding levy of GST on accommodation services, betting and gambling in casinos, horse racing, admission to cinema, homestays, printing, legal services etc.;
10. Circular No. 21/21/2017 dated 22.11.2017 regarding Inter-state movement of rigs, tools and spares, and all goods on wheels [like cranes];
11. Circular No. 20/20/2017 dated 22.11.2017 regarding classification and GST rate on Terracotta idols;
12. Circular No. 19/19/2017 dated 20.11.2017 regarding taxability of custom milling of paddy;
13. Circular No. 16/16/2017 dated 15.11.2017 regarding applicability of GST on certain services;
14. Circular No. 13/13/2017 dated 27.10.2017 regarding unstitched Salwar Suits;
15. Circular No. 12/12/2017 dated 26.10.2017 regarding applicability of GST on the superior kerosene oil [SKO] retained for the manufacture of Linear Alkyl Benzene [LAB]
16. Circular No. 11/11/2017 dated 20.10.2017 regarding taxability of printing contracts;
17. Circular No. 6/6/2017 dated 27.08.2017 regarding classification and rate of GST on lottery tickets.
18. Circular No. 10/10/2017-GST dated 18.10.2017 regarding clarification on movement of goods on approval basis.
19. Circular No. 6/11/2017 dated 27.08.2017 regarding classification and rate of GST on lottery tickets.

Related provisions of the Statute

Section or Rule	Description
Section 1	Short title, extent and commencement
Section 2(84)	Definition of Person
Section 2(107)	Definition of Taxable Person
Section 2(108)	Definition of Taxable Supply
Section 2(45)	Definition of Electronic Commerce Operator
Section 2(98)	Definition of Reverse Charge
Section 10	Composition levy
Section 11	Power to grant exemption from tax
Section 7 (IGST)	Inter-State supply
Section 8 (IGST)	Intra-State supply
Section 15	Value of supply
Section 25	Registration

9.1. Introduction

Article 265 of the Constitution of India mandates that no tax shall be levied or collected except by the authority of law. The charging section is a must in any taxing statute for levy and collection of tax. Before imposing any tax, it must be shown that the transaction falls within the ambit of the taxable event and that the person on whom the tax is so imposed also gets covered within the scope and ambit of the charging Section by clear words used in the Section. No one can be taxed by implication. The scope of the taxable event being 'supply' has been discussed in the earlier part of this Chapter. This Section will provide an insight into the chargeability of tax on a supply. Section 9 is the charging provision of the CGST Act. It provides the maximum rate of tax that can be levied on supplies leviable to tax under this law, the manner of collection of tax and the person responsible for paying such tax.

It is interesting to note that the 4 pillars of taxation that together constitute the cornerstone for levy are couched in Section 9(1). The taxable event, tax rate, collection or levy, and the person to pay are so worded that there is no escape. It appears that the law laid down by the Honourable Supreme Court in Govind Saran Ganga Saran's Case has been carried to its logical end.

9.2. Analysis

The IGST Law provides the basis for determination of a supply as an intra-State supply or an inter-State supply – simply put, if the location of the supplier and the place of supply are within the same State, the transaction will be an intra-State supply, barring the case of supplies made by / to SEZ, and all other supplies will be regarded as inter-State supplies. Please refer

to the discussion in the IGST Chapters for a holistic understanding of 'Levy' as a concept under the GST law.

- (i) **Taxable supply:** Every taxable supply will be subjected to GST. A taxable supply refers to any supply of goods or services or both, which qualifies as a supply in terms of Section 7. The exception to this rule would be all supplies that the levy Section forgoes to tax, as also all those supplies that have been notified to be nil-rated or exempted from tax. The provisions imposing GST are phrased in such a manner so as to **exclude the supply of alcoholic liquor for human consumption** from the scope of levy itself. However, the law specifies certain other goods whereby the levy of GST has been deferred until such time the goods are notified in this regard to be taxable supplies (by the Government, based on the recommendation of the GST Council):
- (1) petroleum crude
 - (2) high speed diesel
 - (3) motor spirit (commonly known as petrol)
 - (4) natural gas and
 - (5) aviation turbine fuel
- (ii) **Tax payable:** The nature of tax would depend upon the nature of supply, viz., inter-State supplies will be liable to IGST and intra-State supplies will be liable to CGST and SGST/UTGST (i.e., UTGST in case intra-State supplies within a particular Union Territory). Every intra-State supply will attract CGST as well as SGST, as follows:
- (1) Imposition of CGST by the Union Government of India
 - (2) Imposition of SGST by the respective State Government or (in case of UTGST, by the Central Government through the appointed Administrator)
- (iii) **Tax shall be payable by a 'taxable person':** The tax shall be payable by a 'taxable person' i.e., a person who is liable to obtain registration, or a person who has obtained registration. Please note that there can be multiple taxable persons for a single person. It comprises separate establishments of persons registered or liable to be registered under sections 22 or section 24 of the CGST Act. *Please refer to the discussion under Section 25 for a thorough understanding of this concept.* Under the GST law, the person liable to pay the tax levied on a supply under the Statute would be one of the following:
- (1) The supplier, in terms of Section 9(1)—Referred to as forward charge. This is ordinarily applicable in case of all supplies unless the supplies qualify under the other two categories, i.e., this would be the residual category of supply wherein the supplier would be liable to pay tax. (In this regard, it must be noted that the term 'supplier' is attributed to an establishment, and not to the PAN as a whole. Therefore, if the supply is effected from an establishment in Karnataka, the

establishment of the same entity located in say Delhi, cannot discharge the liabilities);

- (2) The recipient – Referred to as tax under reverse charge mechanism. In such a case, all the provisions of the Act as are applicable to the supplier in a normal case, would apply to the recipient of supply (being a taxable person, and not the PAN as explained above). A supply would be subjected to tax in the hands of the recipient only in the following cases:
1. Notified supplies under Section 9(3): The supply of goods or services is notified as a supply liable to tax in the hands of the recipient vide Notification No. 4/2017-Central Tax (Rate) in case of goods and Notification No. 13/ 2017-Central Tax (Rate) in case of services, as amended from time to time. Please note that the supplier discharging this liability would not render the liability discharged, since the law imposes the obligation on the recipient. The recipient of supply would nevertheless be liable to discharge the taxes, and the relief available to the supplier would be only by way of an application for refund;
 2. Supplies received from unregistered persons under Section 9(4): The supply is an inward supply of goods and / or services effected by a registered person from an unregistered supplier. In this regard, it may be noted that the levy under this clause applies (as amended by CGST Amendment Act) only in respect of (a) 'class of registered persons' and (b) 'categories of goods or services', by a notification. As of now, no such notification has been issued. As a result, GST on RCM in case of URD will not be operational. Similar position applies to IGST under section 5(4) of IGST Act.

Central Government on the recommendation of the GST Council has notified goods in respect of whose intra-state and inter-state supplies, central/integrated tax shall be paid by the recipient of such goods under reverse charge. These goods are as under:

<i>HSN</i>	<i>Description of goods</i>	<i>Suppliers of goods</i>	<i>Recipient of supply</i>	<i>Notification No.</i>
0801	Cashew nuts, not shelled or peeled	Agriculturist	Any registered person	4/2017-Central Tax (Rate) dated June 28, 2017 and 4/2017-Integrated Tax (Rate) dated June 28, 2017
1404 90 10	Bidi wrapper leaves (tendu)	Agriculturist	Any registered person	4/2017-Central Tax (Rate) dated June 28, 2017 and

				4/2017-Integrated Tax (Rate) dated June 28, 2017
2401	Tobacco leaves	Agriculturist	Any registered person	4/2017-Central Tax (Rate) dated June 28, 2017 and 4/2017-Integrated Tax (Rate) dated June 28, 2017
5004 to 5006	Silk yarn	Any person who manufactures silk yarn from raw silk or silk worm cocoons for supply of silk yarn	Any registered person	4/2017-Central Tax (Rate) dated June 28, 2017 and 4/2017-Integrated Tax (Rate) dated June 28, 2017
-	Supply of lottery	State Government, Union Territory or any local authority	Lottery distributor or selling agent.	4/2017-Central Tax (Rate) dated June 28, 2017 and 4/2017-Integrated Tax (Rate) dated June 28, 2017
Any Chapter	Used vehicles, seized and confiscated goods, old and used goods, waste and scrap	Central Government, State Government, Union territory or a local authority	Any registered person	36/2017-Central Tax (Rate) dated October 13, 2017
Any Chapter	Priority Sector Lending Certificate	Any registered person	Any registered person	11/2018-Central Tax (Rate) dated May 28, 2018

Central Government on the recommendation of the Council has notified the category of supply of services on which GST shall be paid by the recipient on reverse charge basis (**Notification No. 13/2017- Central Tax (Rate) dated 28.06.2017 as amended from time to time**)

Sl. No.	Category of Supply of Services	Supplier of service	Recipient of Service
(1)	(2)	(3)	(4)
1	<p>Supply of Services by a goods transport agency (GTA) who has not paid central tax @ 6% in respect of transportation of goods by road to-</p> <p>(a) any factory registered under or governed by the Factories Act, 1948(63 of 1948);or</p> <p>(b) any society registered under the Societies Registration Act, 1860 (21 of 1860) or under any other law for the time being in force in any part of India; or</p> <p>(c) any co-operative society established by or under any law; or</p> <p>(d) any person registered under the Central Goods and Services Tax Act or the Integrated Goods and Services Tax Act or the State Goods and Services Tax Act or the Union Territory Goods and Services Tax Act; or</p> <p>(e) anybody corporate established, by or under any law; or</p> <p>(f) any partnership firm whether registered or not under any law including association of persons; or</p> <p>(g) any casual taxable person.</p>	Goods Transport Agency (GTA)	<p>(a) Any factory registered under or governed by the Factories Act, 1948(63 of 1948); or</p> <p>(b) any society registered under the Societies Registration Act, 1860 (21 of 1860) or under any other law for the time being in force in any part of India; or</p> <p>(c) any co-operative society established by or under any law; or</p> <p>(d) any person registered under the Central Goods and Services Tax Act or the Integrated Goods and Services Tax Act or the State Goods and Services Tax Act or the Union Territory Goods and Services Tax Act; or</p> <p>(e) anybody corporate established, by or under any law; or</p> <p>(f) any partnership firm whether registered or not under any law including association of persons; or</p> <p>(g) any casual taxable person; located in the taxable territory.</p>
2	Services supplied by an individual advocate Including A senior advocate by way of representational services before any court, tribunal or authority,	An individual Advocate including a Senior	Any business entity located in the taxable territory.

	directly or indirectly, to any business entity located in the taxable territory, including where contract for provision of such service has been entered through another advocate or a firm of advocates, or by a firm of advocates, by way of legal services, to a business entity.	advocate or firm of advocates.	
3	Services supplied by An arbitral tribunal to a business entity.	An arbitral tribunal.	Any business entity located in the taxable territory.
4	Services provided by way of sponsorship to anybody corporate or partnership firm.	Any person	Any body corporate or partnership firm located in the taxable territory.
5	Services supplied by the Central Government, State Government, Union territory or local authority to a business entity excluding, - (1) renting of immovable property, and (2) services specified below- (i) services by the Department of posts by way of speed post, express parcel post, life insurance, and agency services provided to a person other than Central Government, State Government or Union territory or local authority; (ii) services in relation to an aircraft or a vessel, inside or outside the precincts of a port or an airport; (iii) transport of goods or passengers.	Central Government State Government Union territory or local authority	Any business entity located in the taxable territory.
5A	Services supplied by the Central Government, State Government, Union territory or local authority by way of renting of immovable property to a person registered	Central Government, State Government, Union territory	Any person registered under the Central Goods and Services Tax Act, 2017

	under the Central Goods and Services Tax Act, 2017 (12 of 2017). (Inserted vide Notification No.3/2018-Central Tax (Rate) dated January 25, 2018)	or local authority	
6	Services supplied by a director of a company or a body corporate to the said company or the body corporate.	A director of a company or a body corporate	The company or a body corporate located in the taxable territory.
7	Services supplied by an insurance agent to any person carrying on insurance business.	An Insurance agent	Any person carrying on insurance business, located in the taxable territory.
8	Services supplied by a recovery agent to a banking company or a financial institution or a non-banking financial company.	A recovery agent	A banking company or a financial Institution or a non-banking financial company, located in the taxable territory.
9	Supply of services by an author, music composer, photographer, artist or the like by way of transfer or permitting the use or enjoyment of a copyright covered under clause (a) of sub-section (1) of section 13 of the Copyright Act, 1957 relating to original literary, dramatic, musical or artistic works to a publisher, Music company, producer or the like.	Author or music composer, photographer, artist, or the like	Publisher, music company, producer or the like, located in the taxable territory.
10	Supply of services by the members of Overseeing Committee to Reserve Bank of India (Inserted vide Notification No.33/2017-Central Tax (Rate) dated October 13, 2017)	Members of Overseeing Committee constituted by the Reserve Bank of India	Reserve Bank of India.
11	Services supplied by individual Direct Selling Agents (DSAs) other than a body corporate, partnership or limited liability partnership firm to bank or non-	Individual Direct Selling Agents (DSAs) other than a body	A banking company or a non-banking financial company, located in the taxable territory.

	banking financial company (NBFCs). (Inserted vide Notification No.15/2018-Central Tax (Rate) dated July 26, 2018)	corporate, partnership or limited liability partnership firm.	
12	Services provided by business facilitator (BF) to a banking company	Business facilitator (BF)	A banking company, located in the taxable territory
13	Services provided by an agent of business correspondent (BC) to business correspondent (BC).	An agent of business correspondent (BC)	A business correspondent, located in the taxable territory.
14	Security services (services provided by way of supply of security personnel) provided to a registered person: Provided that nothing contained in this entry shall apply to, - (i)(a) a Department or Establishment of the Central Government or State Government or Union territory; or (b) local authority; or (c) Governmental agencies; which has taken registration under the Central Goods and Services Tax Act, 2017 (12 of 2017) only for the purpose of deducting tax under section 51 of the said Act and not for making a taxable supply of goods or services; or (ii) a registered person paying tax under section 10 of the said Act. Any person other than a body corporate. A registered person, located in the taxable territory.”; (Inserted vide Notification No.29/2018-Central Tax (Rate) dated Dec 31, 2018)	Any person other than a body corporate	A registered person, located in the taxable territory.”;

In addition to the above list given under Central Tax- Rate, following additional category of supply of services is listed under Notification No. 10/2017- Integrated Tax (Rate) on which GST shall be paid by the recipient on reverse charge basis:-

Sl. No.	Category of Supply of Services	Supplier of service	Recipient of Service
(1)	(2)	(3)	(4)
1	Any service supplied by any person who is located in a non-taxable territory to any person other than non-taxable online recipient	Any person located in a non-taxable territory	Any person located in the taxable territory other than non-taxable online recipient.
2	Services supplied by a person located in non- taxable territory by way of transportation of goods by a vessel from a place outside India up to the customs station of clearance in India	A person located in non-taxable territory	Importer, as defined in clause (26) of section 2 of the Customs Act, 1962(52 of 1962), located in the taxable territory.

ANALYSIS:-

- No partial reverse charge will be applicable under GST. 100% tax will be paid by the recipient if reverse charge mechanism applies.
 - All taxpayers required to pay tax under reverse charge have to mandatorily obtain registration and the threshold exemption is not applicable on them.
 - Payment of taxes under Reverse Charge cannot be made with utilisation of Input Tax Credit and has to be made in Cash.
 - The recipient can take the credit of tax paid on inward supplies liable to reverse charge once the recipient makes payment of tax in cash.
- (iv) The e-commerce operator, in terms of Section 9(5): The Government is empowered to notify categories of services wherein the person responsible for payment of taxes would nether be the supplier nor the recipient of supply, but the e-commerce operator through which the supply is effected. It is important to note that, in case of such supplies, the e-commerce operator is neither the supplier nor does it receive the services. The e-commerce operator is merely the person who owns, operates or manages digital or electronic facility or platform for e-commerce purposes. Under the erstwhile service tax law, the e-commerce operator in such an arrangement was referred to as an 'aggregator'.
1. The Government has notified certain services in this regard vide Notification No. 17/2017-Central Tax (Rate) as amended from time to time, including services by way of transportation of passengers by a radio-taxi, motor cab, maxi cab and motor cycle, etc.); accommodation in hotels, inns, guest houses, clubs, campsites; services by way of housekeeping, such as plumbing, carpeting etc.
 2. Where the e-commerce does not have a physical presence in the taxable territory,

any person representing his in the taxable territory would be liable to pay the taxes. If no such representative exists, the e-commerce operator is liable to appoint such a person in order to discharge this obligation.

3. All other provisions of the Act will apply to the e-commerce operator or his representative (as the case may be) in respect of such services, as if he is the supplier liable to pay tax on the services.
4. In this regard it may be noted that liability to pay tax on the supply by the e-commerce operator is not another provision imposing tax on the reverse charge basis. Reference to the definition of reverse charge in section 2(98) makes it clear that reverse charge is limited to tax payable under section 9(3) and 9(4). It is very important to note that the language employed in Section 9(5) makes it clear that the liability to pay tax on the supply is placed on the e-commerce operator, "as if" the e-commerce operator were the "supplier liable to tax". The marked departure of the language from that used in case of the reverse charge provisions suggests that:
 - (a) The tax that is applicable on the supply is to be paid by the e-commerce operator "as if" such e-commerce operator was the supplier liable to tax. The provisions require the e-commerce operator to step into the shoes of the actual supplier, for the limited purpose of discharging his liability, and the supply by the e-commerce operator to the actual supplier (facilitation services, commission services or by any service *inter se*) will be taxable separately, in the hands of the e-commerce operator as a supplier of service to the actual supplier.
 - (b) The actual supplier is no longer liable to pay any tax. This means that the suppliers will not be the persons liable to pay tax on such services effected through an e-commerce operator, even if they have obtained registration.

Readers may refer to decision of Karnataka AAR in the matter of Opta Cabs Private Limited as below:

Question raised: Whether the money paid by the customer to the driver of the cab for the services of the trip is liable to GST and whether the applicant company is liable to pay GST on this amount

Ruling: The services of transportation of passengers is supplied to the consumers through the applicant and it shall be deemed that the applicant would be deemed to be the supplier liable to pay tax in relation to the supply of such service by the taxi operator - in accordance with the provisions of sub-section (5) of section 9 of the Central Goods and Services Tax Act 2017 r/w Notification No. 17/2017- Central Tax (Rate), the applicant is liable to tax on the amounts billed by him on behalf of the taxi operators for the service provided in the nature of transportation of passengers through it.

- (iv) **Rate of tax:** The rate of tax will be applicable as specified in the Notification No. 1/2017- Central Tax (Rate) for goods and Notification No. 11/2017- Central Tax (Rate) for services issued in this regard and read with other Rate Notifications which may be issued to partially exempt any other goods or services from payment of tax. The rates of tax contained in these notifications cannot exceed 20% under each limb (i.e., 20% under CGST Law and 20% under SGST), as amended from time to time. These rates would be notified based on the recommendation of the GST Council. In order to determine the applicable rate of tax, the following approach is to be adopted:
- (i) Identify whether the supply is an intra-State supply;
 - (ii) Identify whether the supply is a plain supply / composite supply / mixed supply and adopt the treatment accordingly;
 - (iii) Identify HSN of the goods or services and applicable rate of tax as per rate notification;
 - (iv) Identify whether the HSN applies to more than one description-line. If yes, analyse which of the description is most specific to the supply in question;
 - (v) Once classification is ascertained, identify whether such goods or services qualify for any exemption (partially or wholly) from payment of tax.
- (v) **Taxable value:** The rate of tax so notified will apply on the value of supply as determined under Section 15. The transaction value would be accepted subject to inclusions / exclusions specified in the said Section, where the price is the sole consideration for the supply and the supplier and recipient are not related persons. In all other cases, the value of supply will be that value which is determined in terms of the valuation rules (i.e., Chapter IV of the CGST Rules, 2017).
- (vi) **Classification of Goods or Services:** In order to apply a particular rate of tax, a taxable person need to determine the classification of his supply as to whether supply constitute a supply of goods or services. Once the same is determined, further classification in terms of HSN of goods and services has to be made by the assessee so as to arrive at the rate of tax at which he is required to pay tax. At the outset, it is important to note that HSN for goods are contained in Chapters from 1 to 98 and HSN for Services are contained in Chapter 99. Since Classification of Goods is older and is based on knowledge gathered from precedents on HSN classification, we shall discuss the steps for classification of goods. The steps for determination of proper classification is as under:
- (vii) It is important to note that classification of each product supplied has to be made separately if supply of such product is independent. This shall include all by-products, scraps etc.
 - (viii) Identify the description and nature of the goods being supplied. One must confirm that the product is also similarly or more specifically covered in the Customs Tariff and HSN

2017. The Section Notes and Chapter Notes to the applicable Schedule to be read as it forms an integral part of the Tariff for the purpose of classification.

- (ix) If there is any ambiguity, first reference shall be made to the Rules for interpretation of the Customs Tariff.
- (x) As per the Rules, first step to be applied is to find the trade understanding of the terms used in the Schedule, if the meaning or description of goods is not clear.
- (xi) If the trade understanding is not available, the next step is to refer to the technical or scientific meaning of the term. If the tariff headings have technical or scientific meanings, then that has to be ascertained first before the test of trade understanding.
- (xii) If none of the above are available reference may be had to the dictionary meaning or ISI specifications. Evidence may be gathered on end use or predominant use.
- (xiii) In case of the unfinished or incomplete goods, if the unfinished product bears the essential characteristics of the finished product, its classification shall be same as that of finished product.
- (xiv) If the classification is not ascertained as per above point, one has to look for the nature of product which is more specific.
- (xv) If the classification is still not determinable, one has to look for the ingredient which gives the article its essential characteristics.
- (xvi) It is important to note that in following cases of supply of services, same rate of central tax as on supply of like goods involving transfer of title in goods would be applicable:

SI No.	Chapter, Section or Heading	Description of Service	Rate (per cent.) of Central Tax	Rate (per cent.) of Integrated Tax
15	Heading 9971 (Financial and related services)	(ii) Transfer of the right to use any goods for any purpose (whether or not for a specified period) for cash, deferred payment or other valuable consideration.	Same rate of central tax as on supply of like goods involving transfer of title in goods	Same rate of central tax as on supply of like goods involving transfer of title in goods
		(iii) Any transfer of right in goods	Same rate of central tax as on	Same rate of central tax as on

		or of undivided share in goods without the transfer of title thereof.	supply of like goods involving transfer of title in goods	supply of like goods involving transfer of title in goods
17	Heading 9973 (Leasing or rental services, with or without operator)	(iii) Transfer of the right to use any goods for any purpose (whether or not for a specified period) for cash, deferred payment or other valuable consideration.	Same rate of central tax as on supply of like goods involving transfer of title in goods	Same rate of central tax as on supply of like goods involving transfer of title in goods
		(iv) Any transfer of right in goods or of undivided share in goods without the transfer of title thereof.	Same rate of central tax as on supply of like goods involving transfer of title in goods	Same rate of central tax as on supply of like goods involving transfer of title in goods
		(vi) Leasing or rental services, with or without operator, other than (i), (ii), (iii), (iv) and (v) above.	Same rate of central tax as applicable on supply of like goods involving transfer of title in goods	Same rate of central tax as applicable on supply of like goods involving transfer of title in goods

(xvii) The only exception to the above table is leasing of motor vehicle which was purchased by the Lessor prior to July 1, 2017, leased before July 1, 2017 and no ITC of central excise, VAT or any other taxes on such motor vehicle was availed by him. If all these conditions are fulfilled then the lessor is liable to pay GST only on 65% of the GST applicable on such motor vehicle. – Refer notification No.37/2017- Central Tax (Rate) dated October 13, 2017.

9.3 Comparative review

Under the erstwhile tax laws, Central Excise is levied on 'manufacture of goods', VAT / CST is

levied on 'sale of goods' and service tax is charged on 'service provided or agreed to be provided'. Unlike such different incidences, under the GST law, it is 'supply' which would be the taxable event. Under the erstwhile law, e.g.: while stock transfers are liable to Central Excise (if they are removed from the factory), it would not be liable to VAT / CST on production of necessary forms – however, under the GST law, it would be taxable as a 'supply' if such supplies are between distinct persons under section 25(4) or 25(5). Further, free supplies were liable to excise duty, while under the VAT laws, free supplies would require reversal of input tax credit; under the GST law, we have to be careful to analyse whether there is any non-monetary consideration (inducement) present in the supplies (free-marketed as), if yes then we have to get into valuation of such free supplies to arrive at a transaction value. If not, then the treatment would be similar to the erstwhile VAT laws, where the supplies are made without any consideration (monetary/ otherwise). However, where the free supplies are made between distinct persons or between related persons then such supplies may be regarded as supply under Schedule I, paragraph 2.

In the erstwhile law, there are multiple transactions which apparently qualify as both 'sale of goods' as well as 'provision of services'. E.g.: license of software, providing a right to use a brand name, etc. To avoid this situation, GST law clarifies as to whether a transaction would qualify as a 'supply of goods' or as 'supply of services' by introducing a deeming fiction. A transaction of supply under composite contracts would either qualify as supply of goods or as services, under the GST law (Schedule II of the Act, concept of composite supply and mixed supply).

The payment of VAT in the hands of the purchaser (registered dealer) on purchase of goods from an unregistered dealer and the circumstances where the Service Tax is payable under the reverse charge mechanism in respect of say, advocate services, import of services, sponsorship services etc. are comparable to the 'reverse charge mechanism' prescribed herein. However, the concept of partial reverse charge is not continuing in the GST regime, viz., every supply will be liable either to forward charge or full reverse charge. Further, under erstwhile law, the concept of reverse charge only exists in relation to services. The GST law, however, permits the supply of goods also to be subjected to reverse charge.

9.4 Issues and concerns

1. The activity of import of service is subjected to tax, whether or not such import is in the course or furtherance of business. While the relaxation from obtaining registration is provided to a 'non-taxable online recipient' who imports OIDAR services, there is no relaxation to other persons who import services for personal use, and they shall be mandated to obtain registration regardless of the turnover, given that the service is listed as a supply attracting tax on reverse charge basis. For instance, say a person engages an artist from a different country to send designs for apparel manufacture, which he wishes to gift, the transaction would be a taxable supply, and liable to tax in the hands of such person importing the service.

2. Although, the word 'business' is clearly defined u/s 2(17), the phrase 'in the course or furtherance of business' has not been defined in the Act. The meaning that can be derived from this phrase is so wide that it can include every activity undertaken by a business concern, including activities in the course of employment, since employment is a subset of the activities undertaken in the course of business.
3. A plain reading of the meaning of the terms 'composite supply' and 'mixed supply' suggests that the concepts pre-suppose a condition that they are effected by taxable persons. Say in case of a supply effected by a non-taxable person to a registered person attracting tax under reverse charge, the supply would not be regarded as a composite supply even where all the conditions are satisfied, and cannot be regarded as a mixed supply either, for the same reason. Such an understanding would defeat the very purpose of the legislative intent. Therefore, in case of reverse charge transactions, the supply must be understood to have been made by the registered person who is the recipient of supply, i.e., even supplies effected by unregistered persons may be qualified to be termed 'composite supply' or mixed supply', subject to the normal conditions which would otherwise apply.
4. While the concept of 'mixed supplies' requires that the goods and / or services supplied in the mixed supply must be supplied for a single price, there is no such requirement in the case of composite supplies. Therefore, a person effecting a mixed supply of goods would certainly have an option to strategically alter the bundle of supplies so that all the goods / services included in the mixed supply would not all be subjected to the highest rate of tax applicable on the said supplies.

On the other hand, a supplier who effects a composite supply wishes to charge for the supply of two or more goods or services separately, which otherwise constitute a composite supply, a question may arise as to whether the rate of tax applicable on all the supplies would continue to be the rate applicable to the principal supply. Say, a supplier of air conditioners (taxable @ 28%) who always effects the supply along with the installation service, now chooses to split the cost of the service in order to tax such service portion at the rate of 18%. Such a split-up may be questioned, given that there is no escape from treatment as a composite supply merely because the values are ascertained separately. Generally, transactions that are intentionally broken up with an intent to minimise the impact of tax would be subject to scrutiny / valuation.

9.5 FAQs

Q1. In respect of exchange of goods, namely gold watch for restaurant services, will the transaction be taxable as two different supplies or will it taxable only in the hands of the main supplier?

Ans. Yes, the transaction of exchange is specifically included in the scope of "supply" under Section 7. Thus, exchange could be taxable both ways. Provided the person

exchanging gold watch is in the business of selling watches (A contrary view could also be taken. It depends on the facts of each and every case).

Q2. What are examples of 'disposals' as used in 'supply'?

Ans. "Disposals" could include donation in kind or supplies in a manner other than sale.

Q3. Will a not-for-profit entity be liable to tax (if registered under GST) on any supplies effected by it – e.g.: sale of assets received as donation?

Ans. Yes, it would be liable to tax on value as may be determined under Section 15, for said sale of donated assets.

Q4. Is the levy under reverse charge mechanism applicable only to services?

Ans. No, reverse charge applies to supplies of both goods and services by virtue of Notification No.4/2017-CT(Rate) and Notification No.13/2017-CT(Rate) for goods and services respectively.

Q5. What will be the implications in case of purchase of goods from unregistered dealers?

Ans. As per Section 9(4) of the CGST Act, 2017 as amended by The CGST Amendment Act, 2018 specified that the tax shall be payable under reverse charge by the specified class of registered persons, in respect of supply of specified categories of goods.

9.6 MCQs

Q1. As per Section 9, which of the following would attract levy of CGST?

- (a) Inter-State supplies, in respect of supplies within the State to SEZ;
- (b) Intra-State supplies;
- (c) Both of the above;
- (d) Either of the above.

Ans. (b) Intra-State supplies

Q2. Which of the following forms of supply are included in Schedule I?

- (a) Permanent transfer of business assets on which input tax credit has been claimed
- (b) Agency transactions for services
- (c) Barter
- (d) None of the above

Ans. (a) Permanent transfer of business assets on which input tax credit has been claimed

Q3. Who can notify a transaction to be supply of 'goods' or 'services'?

- (a) CBIT
- (b) Central Government on the recommendation of GST Council
- (c) GST Council
- (d) None of the above

Ans. (b) Central Government on the recommendation of GST Council

Statutory Provisions- Effective from 1st July, 2017 to 31st January, 2019

10. Composition levy

(1) *Notwithstanding anything to the contrary contained in this Act but subject to the provisions of sub-sections (3) and (4) of section 9, an eligible registered person, whose aggregate turnover in the preceding financial year did not exceed fifty lakh rupees, may opt to pay, in lieu of the tax payable by him, an amount calculated at such rate as may be prescribed, but not exceeding,—*

- (i) *one per cent. of the turnover in State or turnover in Union territory in case of a manufacturer,*
- (ii) *two and a half per cent. of the turnover in State or turnover in Union territory in case of persons engaged in making supplies referred to in clause (b) of paragraph 6 of Schedule II, and*
- (iii) *half per cent. of the turnover in State or turnover in Union territory in case of other suppliers,*

subject to such conditions and restrictions as may be prescribed:

Provided that the Government may, by notification, increase the said limit of fifty lakh rupees to such higher amount, not exceeding one crore rupees, as may be recommended by the Council

(2) *The registered person shall be eligible to opt under sub-section (1), if:—*

- (a) *he is not engaged in the supply of services other than supplies referred to in clause (b) of paragraph 6 of Schedule II;*
- (b) *he is not engaged in making any supply of goods which are not leviable to tax under this Act;*
- (c) *he is not engaged in making any inter-State outward supplies of goods;*
- (d) *he is not engaged in making any supply of goods through an electronic commerce operator who is required to collect tax at source under section 52; and*
- (e) *he is not a manufacturer of such goods as may be notified by the Government on the recommendations of the Council:*

Provided that where more than one registered persons are having the same Permanent Account Number (issued under the Income-tax Act, 1961), the registered person shall not be eligible to opt for the scheme under sub-section (1) unless all such registered persons opt to pay tax under that sub-section.

- (3) *The option availed of by a registered person under sub-section (1) shall lapse with effect from the day on which his aggregate turnover during a financial year exceeds the limit specified under sub-section (1).*
- (4) *A taxable person to whom the provisions of sub-section (1) apply shall not collect any tax from the recipient on supplies made by him nor shall he be entitled to any credit of input tax.*
- (5) *If the proper officer has reasons to believe that a taxable person has paid tax under sub-section (1) despite not being eligible, such person shall, in addition to any tax that may be payable by him under any other provisions of this Act, be liable to a penalty and the provisions of section 73 or section 74 shall, mutatis mutandis, apply for determination of tax and penalty.*

Statutory Provisions- Effective from 1st February 2019 vide The Central Goods & Services Tax Amendment Act,2018

10. Composition levy

- (1) *Notwithstanding anything to the contrary contained in this Act but subject to the provisions of sub-sections (3) and (4) of section 9, an eligible registered person, whose aggregate turnover in the preceding financial year did not exceed fifty lakh rupees, may opt to pay, in lieu of tax payable under sub-section (1) of section 9, an amount calculated at such rate as may be prescribed, but not exceeding,—*

- (i) *one per cent. of the turnover in State or turnover in Union territory in case of a manufacturer,*
- (ii) *two and a half per cent. of the turnover in State or turnover in Union territory in case of persons engaged in making supplies referred to in clause (b) of paragraph 6 of Schedule II, and*
- (ii) *half per cent. of the turnover in State or turnover in Union territory in case of other suppliers,*

subject to such conditions and restrictions as may be prescribed:

Provided that the Government may, by notification, increase the said limit of fifty lakh rupees to such higher amount, not exceeding one crore and fifty lakh rupees, as may be recommended by the Council

Provided further that a person who opts to pay tax under clause (a) or clause (b) or clause (c) may supply services (other than those referred to in clause (b) of paragraph

6 of Schedule II), of value not exceeding ten per cent. of turnover in a State or Union territory in the preceding financial year or five lakh rupees, whichever is higher.

- (2) *The registered person shall be eligible to opt under sub-section (1), if: —*
- (a) *save as provided in sub-section (1), he is not engaged in the supply of services;*
 - (b) *he is not engaged in making any supply of goods which are not leviable to tax under this Act;*
 - (c) *he is not engaged in making any inter-State outward supplies of goods;*
 - (d) *he is not engaged in making any supply of goods through an electronic commerce operator who is required to collect tax at source under section 52; and*
 - (e) *he is not a manufacturer of such goods as may be notified by the Government on the recommendations of the Council:*

Provided that where more than one registered persons are having the same Permanent Account Number (issued under the Income-tax Act, 1961), the registered person shall not be eligible to opt for the scheme under sub-section (1) unless all such registered persons opt to pay tax under that sub-section.

- (3) *The option availed of by a registered person under sub-section (1) shall lapse with effect from the day on which his aggregate turnover during a financial year exceeds the limit specified under sub-section (1).*
- (4) *A taxable person to whom the provisions of sub-section (1) apply shall not collect any tax from the recipient on supplies made by him nor shall he be entitled to any credit of input tax.*
- (5) *If the proper officer has reasons to believe that a taxable person has paid tax under sub-section (1) despite not being eligible, such person shall, in addition to any tax that may be payable by him under any other provisions of this Act, be liable to a penalty and the provisions of section 73 or section 74 shall, mutatis mutandis, apply for determination of tax and penalty.*

Extract of the CGST Rules, 2017

3. Intimation for composition levy.

- (1) *Any person who has been granted registration on a provisional basis under clause (b) of sub-rule (1) of rule 24 and who opts to pay tax under section 10, shall electronically file an intimation in FORM GST CMP-01, duly signed or verified through electronic verification code, on the common portal, either directly or through a Facilitation Centre notified by the Commissioner, prior to the appointed day, but not later than thirty days after the said day, or such further period as may be extended by the Commissioner in this behalf:*

Provided that where the intimation in FORM GST CMP-01 is filed after the appointed

day, the registered person shall not collect any tax from the appointed day but shall issue bill of supply for supplies made after the said day.

- (2) Any person who applies for registration under sub-rule (1) of rule 8 may give an option to pay tax under section 10 in Part B of FORM GST REG-01, which shall be considered as an intimation to pay tax under the said section.
- (3) Any registered person who opts to pay tax under section 10 shall electronically file an intimation in FORM GST CMP-02, duly signed or verified through electronic verification code, on the common portal, either directly or through a Facilitation Centre notified by the Commissioner, prior to the commencement of the financial year for which the option to pay tax under the aforesaid section is exercised and shall furnish the statement in FORM GST ITC-03 in accordance with the provisions of sub-rule (4) of rule 44 within a period of sixty days from the commencement of the relevant financial year.
- (3A) Notwithstanding anything contained in sub-rules (1), (2) and (3), a person who has been granted registration on a provisional basis under rule 24 or who has been granted certificate of registration under sub-rule (1) of rule 10 may opt to pay tax under section 10 with effect from the first day of the month immediately succeeding the month in which he files an intimation in FORM GST CMP-02, on the common portal either directly or through a Facilitation Centre notified by the Commissioner, on or before the 31st day of March, 2018, and shall furnish the statement in FORM GST ITC-03 in accordance with the provisions of sub-rule (4) of rule 44 within a period of one hundred and eighty days from the day on which such person commences to pay tax under section 10:
- Provided that the said persons shall not be allowed to furnish the declaration in FORM GST TRAN-1 after the statement in FORM GST ITC-03 has been furnished.*
- (4) Any person who files an intimation under sub-rule (1) to pay tax under section 10 shall furnish the details of stock, including the inward supply of goods received from unregistered persons, held by him on the day preceding the date from which he opts to pay tax under the said section, electronically, in FORM GST CMP-03, on the common portal, either directly or through a Facilitation Centre notified by the Commissioner, within a period of ninety days from the date on which the option for composition levy is exercised or within such further period as may be extended by the Commissioner in this behalf.
- (5) Any intimation under sub-rule (1) or sub-rule (3) or sub-rule (3A) in respect of any place of business in any State or Union territory shall be deemed to be an intimation in respect of all other places of business registered on the same Permanent Account Number.

4. Effective date for composition levy.

- (1) The option to pay tax under section 10 shall be effective from the beginning of the

financial year, where the intimation is filed under sub-rule (3) of rule 3 and the appointed day where the intimation is filed under sub-rule (1) of the said rule.

- (2) *The intimation under sub-rule (2) of rule 3, shall be considered only after the grant of registration to the applicant and his option to pay tax under section 10 shall be effective from the date fixed under sub-rule (2) or (3) of rule 10.*

5. Conditions and restrictions for composition levy.

- (1) *The person exercising the option to pay tax under section 10 shall comply with the following conditions, namely:-*

- (a) *he is neither a casual taxable person nor a non-resident taxable person;*
- (b) *the goods held in stock by him on the appointed day have not been purchased in the course of inter-State trade or commerce or imported from a place outside India or received from his branch situated outside the State or from his agent or principal outside the State, where the option is exercised under sub-rule (1) of rule 3;*
- (c) *the goods held in stock by him have not been purchased from an unregistered supplier and where purchased, he pays the tax under sub-section (4) of section 9;*
- (d) *he shall pay tax under sub-section (3) or sub-section (4) of section 9 on inward supply of goods or services or both;*
- (e) *he was not engaged in the manufacture of goods as notified under clause (e) of sub-section (2) of section 10, during the preceding financial year;*
- (f) *he shall mention the words –composition taxable person, not eligible to collect tax on supplies // at the top of the bill of supply issued by him; and*
- (g) *he shall mention the words –composition taxable person // on every notice or signboard displayed at a prominent place at his principal place of business and at every additional place or places of business.*

- (2) *The registered person paying tax under section 10 may not file a fresh intimation every year and he may continue to pay tax under the said section subject to the provisions of the Act and these rules.*

6. Validity of composition levy.

- (1) *The option exercised by a registered person to pay tax under section 10 shall remain valid so long as he satisfies all the conditions mentioned in the said section and under these rules.*
- (2) *The person referred to in sub-rule (1) shall be liable to pay tax under sub-section (1) of section 9 from the day he ceases to satisfy any of the conditions mentioned in section 10 or the provisions of this Chapter and shall issue tax invoice for every*

taxable supply made thereafter and he shall also file an intimation for withdrawal from the scheme in FORM GST CMP-04 within seven days of the occurrence of such event.

- (3) The registered person who intends to withdraw from the composition scheme shall, before the date of such withdrawal, file an application in FORM GST CMP-04, duly signed or verified through electronic verification code, electronically on the common portal.
- (4) Where the proper officer has reasons to believe that the registered person was not eligible to pay tax under section 10 or has contravened the provisions of the Act or provisions of this Chapter, he may issue a notice to such person in FORM GST CMP-05 to show cause within fifteen days of the receipt of such notice as to why the option to pay tax under section 10 shall not be denied.
- (5) Upon receipt of the reply to the show cause notice issued under sub-rule (4) from the registered person in FORM GST CMP-06, the proper officer shall issue an order in FORM GST CMP-07 within a period of thirty days of the receipt of such reply, either accepting the reply, or denying the option to pay tax under section 10 from the date of the option or from the date of the event concerning such contravention, as the case may be.
- (6) Every person who has furnished an intimation under sub-rule (2) or filed an application for withdrawal under sub-rule (3) or a person in respect of whom an order of withdrawal of option has been passed in FORM GST CMP-07 under sub-rule (5), may electronically furnish at the common portal, either directly or through a Facilitation Centre notified by the Commissioner, a statement in FORM GST ITC-01 containing details of the stock of inputs and inputs contained in semi-finished or finished goods held in stock by him on the date on which the option is withdrawn or denied, within a period of thirty days from the date from which the option is withdrawn or from the date of the order passed in FORM GST CMP-07, as the case may be.
- (7) Any intimation or application for withdrawal under sub-rule (2) or (3) or denial of the option to pay tax under section 10 in accordance with sub-rule (5) in respect of any place of business in any State or Union territory, shall be deemed to be an intimation in respect of all other places of business registered on the same Permanent Account Number.

7. Rate of tax of the composition levy.

The category of registered persons, eligible for composition levy under section 10 and the provisions of this Chapter, specified in column (2) of the Table below shall pay tax under section 10 at the rate specified in column (3) of the said Table:-

Sl. No.	Category of registered persons	Rate of tax
1	Manufacturers, other than manufacturers of such goods as may be notified by the Government	half per cent. of the turnover in the State or Union territory
2	Suppliers making supplies referred to in clause (b) of paragraph 6 of Schedule II	two and a half per cent. of the turnover in the State or Union territory
3	Any other supplier eligible for composition levy under section 10 and the provisions of this Chapter	half per cent. of the turnover of taxable supplies of goods and services of the turnover in the State or Union territory

Relevant circulars, notifications, clarifications issued by Government

1. Notification No. 1/2018-Central Tax dated 23.01.2018 issued for revision of Rules and for reduction of rate of composition tax;
2. Notification No. 46/2017- Central Tax dated 13.10.2017 issued to increase the threshold limit on aggregate turnover to opt for composition scheme (1 crore / 75 Lakhs);
3. Order No. 11/2017-GST dated 21.12.2017 issued to extend the time limit to furnish intimation for opting into the Composition Scheme;
4. Order No. 01/2017-Central Tax being the CGST (Removal of Difficulties) Order, 2017 dated 13.10.2017 issued to clarify that outward supply of services for which the consideration is in the form of interest, shall not be taken into account for composition taxpayers;
5. Chapter eleven of the compilation of the GST Flyers as issued by the CBIC can be referred to for a gist of the statutory provisions, titled '*Composition Levy Scheme in GST*'.
6. Notification No. 22/2017- Central Tax dated 17.08.2017 issued to extend the time limit to file FORM GST CMP-03 giving details of stock, including the inward supply of goods received from unregistered persons, held by him on the day preceding the date from which he opts to pay tax u/s 10.
7. Notification No. 34/2017- Central Tax dated 15.09.2017 issued to insert sub section (3A) in the GST Rules as amended through Notification No. 45/2017-CT dated 13.10.2017.
8. Notification No.8/2017 issued on 27.07.2017 as amended from time to time specifying turnover limits for the applicability of section 10,
9. Notification No 3/2018-CT dated 23.01.2018 issued amending the rate of tax as mentioned in rule 7 of the CGST Rules, 2017.

Related provisions of the Statute

Section	Description
Section 9	Levy and collection
Section 2(6)	Definition of Aggregate turnover
Section 2(102)	Definition of Services
Section 2(78)	Definition of Non-taxable supply
Section 2(112)	Meaning of Turnover in a State
Section 52	Collection of tax at source

10.1 Introduction

This Section provides for a registered person to opt for payment of taxes under a scheme of composition, the conditions attached thereto and the persons who are entitled, but not mandated, to make payment of tax under this Scheme. The conditions, restrictions, procedures and the documentation in respect of this scheme are contained in Chapter II of the Central Goods and Service Tax Rules, 2017 from Rule 3 to Rule 7 (Composition Rules).

10.2 Analysis

Tax payment under this scheme is an option available to the taxable person. This scheme would be available only to certain eligible persons.

- (a) **Payment of tax:** The composition scheme offers to a registered person, the option to remit taxes on the turnover as against outward supply-wise payment of taxes. In other words, the registered person opting to pay tax under the composition scheme needs only to ascertain the aggregate value of outward taxable supplies, and compute the tax thereon at a fixed rate, regardless of the actual rate of tax applicable on the said outward supply. The rate of tax prescribed in this regard is as under:
- i. In case of manufacturers: 1% (0.5% CGST+ 0.5% SGST) of the turnover in the State/UT (Note: The rate applicable has been reduced from 2% to 1% vide Notification No. 1/2018-Central Tax dated 23.01.2018 effective 01.01.2018);
 - ii. In case of food/restaurant services: 5% (2.5% CGST+ 2.5% SGST) of the turnover in the State/UT (*i.e., in case of composite supply of service specified in Entry 6(b) of Schedule II*);
 - iii. In case of other suppliers: 1% (0.5% CGST+ 0.5% SGST) of the turnover of taxable supplies in the State/UT (*such as like traders, agents for supply of goods, etc.*)
- (b) **Eligibility to pay tax under composition scheme:** The conditions for eligibility to opt for payment of tax under the composition scheme is as follows:
- i. Registered persons having an 'aggregate turnover' as defined under Section 2(6) of the Act (*i.e., aggregate of turnovers across all States under the same PAN,*

including exempt supplies, supplies specified under Schedule I, etc.) does not exceed the prescribed limit in the preceding financial year will be eligible to opt for payment of tax under the composition scheme. *Please refer to the discussion on aggregate turnover as explained in the definitions Chapter for a better understanding of the expression.* In this regard, the following may be noted:

1. The prescribed threshold limit is Rs. 1 crore (and Rs. 75 lacs in case of Special Category States being Arunachal Pradesh, Assam, Manipur, Meghalaya, Mizoram, Nagaland, Sikkim, Tripura and Himachal Pradesh); The prescribed threshold limit is Rs. 1.5 crores (including States of Jammu & Kashmir, Assam, Uttarakhand and Himachal Pradesh).

For Special Category States, the limit is Rs. 75 Lakh (except States of Jammu & Kashmir, Assam, Uttarakhand and Himachal Pradesh)

2. The aggregate turnover of the registered person should not exceed the said prescribed limit during the financial year in which the scheme has been availed;
3. The 'aggregate turnover' as computed for a composition taxpayer shall not include any interest income, which is earned by way of supply of services such as extending deposits, etc. where such interest or discount is exempted under the GST Law.

Central Goods and Services Tax (Amendment) Act, 2018

The threshold limit upto which the Government has powers to notify the eligibility limit for of Composition levy has been increased to Rs.1.50 crores from existing Rs.1 crore.

It is effective from a date yet to be notified by the Government.

4. As per Order No. 01/2017 dated 13.10.2017 the following is clarified:-
 - i. A person supplying restaurant services along with the supply of any exempt services shall not be eligible for composition scheme u/s 10 of CGST.
 - ii. In computing the limit of aggregate turnover in order to determine the eligibility of composition scheme, value of supply of any exempt service shall not be taken into account.
- ii. The scheme cannot be opted for during the middle of a financial year, except in the case where the person obtains registration, and opts for composition scheme at the time of applying for registration under the GST Law:
 1. **Taxable Person obtaining a new registration under GST laws:** Such option can be exercised at the time of obtaining registration under section 22 in Part B of Form GST-REG-1. Such new application may also include cases of migration from the erstwhile laws. In both cases, the option to pay tax under composition scheme shall be effective from the effective date of registration. [Refer Rule 3 of CGST Rules]

2. **Registered person switches over to composition scheme:** A person is required to file an intimation before the commencement of the financial year for which he opts to pay tax under the scheme. In such cases, the provisions of section 18(4) shall stand attracted and the registered person shall be required to file a statement containing details of stock and inward supply of goods received from un-registered persons, held in stock, on the date immediately preceding the date. Please refer to the discussion in Section 18 for a better understanding.
- iii. In order to be eligible to opt for the scheme, the registered person must not be in possession of stock of goods which has been purchased from unregistered persons. In any such case, due tax ought to have been paid thereon under Section 9(4);

Note: In case of migrated registrations from the erstwhile laws, the GST Law imposes an additional condition that the stock of goods held on the GST appointed day (01.07.2017) does not include any goods which have been procured in the course of inter-State trade or commerce or received from his branch / his agent / his principal situated outside the State or imported from a place outside India.

- iv. The registered person would **not** be eligible to effect any:
 1. Supply of goods **through an e-commerce operator** who is liable to collect tax at source (TCS) – while there is no restriction on goods supplier through a portal owned and operated by the same person;
In this regard, it may be noted that the provision for TCS has been notified recently to be effective from 01.10.2018.
 2. Supply of **non-taxable goods**, i.e., alcoholic liquor for human consumption, petroleum crude, high speed diesel, motor spirit (commonly known as petrol), natural gas and aviation turbine fuel;
 3. Supply of **services**, other than services specified in Entry 6(b) to Schedule II. This would mean, a trader opting for composition scheme will not be entitled to provide any after-sales support services, howsoever trivial they may be (unless such supply is a composite or mixed supply of goods). In this regard, it must be noted that the Government has issued an order for the removal of difficulties to clarify that any services provided by a composition taxpayer shall not be taken into account where the consideration for the said service is by way of “interest” which is exempted from tax under the GST Law.

Removal of Difficulty Order

One of the difficulties which was initially faced by such persons was that if he earns any interest income (particularly in a proprietorship firm) then that would have been deemed to be a supply against service under GST and therefore, any registered person receiving interest income in course of

furtherance of business shall be deemed to be supplying services. Thus, such registered person shall not be eligible for opting composition scheme. To overcome such difficulties an order was passed, The Central Goods and Services Tax (Removal of Difficulties) Order, 2017 to clarify as under:

- “(i) it is hereby clarified that if a person supplies goods and/or services referred to in clause (b) of paragraph 6 of Schedule II of the said Act and also supplies any exempt services including services by way of extending deposits, loans or advances in so far as the consideration is represented by way of interest or discount, the said person shall not be ineligible for the composition scheme under section 10 subject to the fulfilment of all other conditions specified therein.*
- (ii) it is further clarified that in computing his aggregate turnover in order to determine his eligibility for composition scheme, value of supply of any exempt services including services by way of extending deposits, loans or advances in so far as the consideration is represented by way of interest or discount, shall not be taken into account.”*

Central Goods and Services Tax (Amendment) Act, 2018

A registered person under Section 10 is allowed to supply services upto a value not exceeding 10% of the turnover in a State or UT in preceding financial year or 5 lakhs whichever is higher. This has been inserted through a proviso to Section 10.

4. **Inter-State outward supplies**, including supplies to SEZ unit / developer. Please note that this condition implies that the registered person will not be in a position to effect inter-State stock transfers to its own establishments located outside the State. It is also important to note that the condition is not limited to taxable supplies alone, and extends to exempt supplies as well.
- v. Shall not collect tax: Taxable person opting to pay tax under the composition scheme is prohibited from collecting tax on the outward supplies. Care must be taken when composition taxable persons are involved in supply of MRP-goods. MRP includes output tax and selling at MRP violates this condition. The impact is far more severe as the composition facility gets rejected and full output tax is liable to be paid but input tax credit (otherwise available) would not have been availed within the relevant time permitted.
- vi. Not entitled to input tax credit: Taxable person opting to pay tax under the composition scheme will not be eligible to claim any input tax credits.

However, if the taxable person becomes ineligible to remain under composition scheme, the taxable person will become entitled to take input tax in respect of inputs held in stock (as inputs, contained in semi-finished or finished goods) on the day immediately preceding the date from which he becomes liable to pay tax under

Section 9. (Refer Section 18(1)(c) for the provision. A statement of stock shall be filed in Form GST ITC-1 within 30 days from the date from which the option is withdrawn or the order cancelling the composition option is passed).

- vii. The registered person must **not** be:
1. A manufacturer of such goods as may be notified by the Government (based on the recommendations of the GST Council), in the year for which he opts for the scheme, or in the preceding financial year (E.g. Ice cream, pan masala, tobacco). However, there is no restriction in trading of such goods, i.e., where the person has not manufactured the goods.
 2. A casual taxable person;
 3. A non-resident taxable person;
- viii. All the registrations obtained under a single PAN are also mandated to opt for payment under the composition scheme, i.e., all the registered persons under the PAN will also be mandated to comply with all the conditions mentioned above, including the business verticals having separate registrations within the same State under the same PAN. The scheme would become applicable for all the registrations and it cannot be applied for select verticals only. E.g.: Say a company has the following businesses separately registered:
- Sale of mobile devices (Registered in Kerala)
 - Franchisee of branded restaurant (Registered in Goa)
- The scheme would be applicable for the said 2 units. The company cannot opt for composition scheme for the registration in Kerala and opt to pay taxes under the regular scheme for the registration in Goa.
- ix. The scheme will be applicable to all the outward supplies. The option of the scheme will be qua-person and not qua-class of goods – once opted it will be applicable for all supplies by effected by the registered person; it must be noted that a taxable person **cannot** opt for payment of taxes under composition scheme for supply of one class of goods and opt for regular scheme of payment of taxes for supply of other classes of goods or services.

- (c) **Conditions applicable on a composition supplier:** Once a person has opted to pay tax under the composition scheme, the following conditions would stand attracted:
- i. Every notice or signboard in every registered place of business, displayed at a prominent place, shall carry the words “Composition taxable person”;
 - ii. Every bill of supply issued by the composition suppliers shall carry the declaration “Composition taxable person, not eligible to collect tax on supplies” on top of the bill;
 - iii. RCM on inward supplies: The composition supplier shall be liable to make payment at the rate applicable on the supply in respect of every inward supply liable to tax

under the reverse charge mechanism, regardless of the rate of tax that is applied by him on the outward supplies effected by him. It may be noted that the value of such inward supplies would not be included in the aggregate turnover of the composition taxpayer although the liability is discharged by him on such inward supplies;

- iv. Not entitled to collect tax: The composition taxpayer is prohibited from collecting any GST / Cess applicable on the outward supplies effected by him. Accordingly, the recipients of supply would also not be eligible to claim any credits where the inward supply is from a composition taxpayer;
- v. Not entitled to claim credit of taxes paid: The composition taxpayer is not entitled to claim credit in respect of taxes paid by him on any of the inward supplies effected by him, including inward supplies on which he pays tax under reverse charge mechanism.
- vi. A Composition supplier shall not be entitled to issue any tax invoice. However, to effect supplies of goods/services the supplier will have to issue "Bill of Supply" without indicating any tax amount on it.

However, if the composition taxpayer switches over to become a regular taxpayer, he will be entitled to take input tax in respect of inputs held in stock (as inputs, contained in semi-finished or finished goods) on the day immediately preceding the date from which he becomes liable to pay tax under Section 9 (regular taxpayer). Refer the discussion in Section 18(1)(c) for a better understanding of the provisions.

(d) **Important Note:** The option to pay tax under the composition scheme will remain valid so long as the registered persons comply with all of the aforesaid conditions in (b) and (c) above. The composition suppliers will be treated as any other registered supplier with effect from the date on which any of the said conditions cease to be complied with. The composition suppliers would not be entitled to re-enter the scheme until the expiry of the financial year.

- i. The registered person would be required to file an intimation (*suo motu*) for withdrawal from the scheme within 7 days of the non-compliance;
- ii. The registered person may also file an intimation if he wishes to withdraw from the scheme, before the effective date of withdrawal, and such withdrawal can be applied for anytime during the financial year.

Once granted, the eligibility would be valid unless the permission is cancelled or is withdrawn or the person becomes ineligible for the scheme.

- iii. Cancellation of permission: Where the proper officer has reasons to believe that the taxable person was not eligible to the composition scheme, the proper officer may cancel the permission (in order CMP-7) and demand the following:
 - a. Differential tax and interest – viz., tax payable under the other provisions of the Act after deducting the tax paid under composition scheme;
 - b. Penalty determined based on the demand provisions under Section 73 or 74.

- (e) **Comments specific to migration cases (transition from the erstwhile law to the GST regime):** In case of migration of old registration into registration under GST, option to avail composition scheme under GST Laws can be exercised only if the goods held in stock by such taxable person, on the appointed day have not been purchased in the course of inter-state trade or commerce or imported from a place outside India or received from his branch situated outside the State, or from his agent or principal outside the State.
- (i) As per rule 3(1) of the CGST Rules, in cases involving migration, there is need to exercise such Option for composition in Form GST CMP 01 prior to appointed date or within 30 days after the appointed date. In this case, the option to pay tax under composition scheme shall be effective from the appointed date. This date has further been extended to 16.08.2017. Such person would be required to file stock statement under Rule 3(4) in Form GST-CMP03 within a period of 90 days (extended from 60 days to 90 days by Notification No.22/2017) from the date on which the option for composition levy is exercised or within such further period as may be extended by the Commissioner in this behalf. However, the due date was extended further till 31.01.2018 vide Order No. 11/2017-GST dated 21.12.2017.
- (ii) A new sub-rule (3A) was inserted by Notification No.34/2017 – Central Tax dtd.15.09.2017 which has an overriding effect on provisions of sub-rule (1), (2) and (3). It may be noted that, the purpose of rule (3A) is only to enable the persons to opt for composition scheme in the first year of GST implementation, without making them to wait up to the next financial year. This is on account of the fact that, the threshold limit for the purposes of Composition scheme u/s 10 was enhanced twice i.e. once on 27.06.2017 and then again on 13.10.2017. Hence, sub-rule (3A) would only cover cases, where the application is made prior to 31.03.2018. For all applications made during the financial year 2018-19, the matter would be governed by Rule 3(3).

10.3 Comparative review

Under the erstwhile tax laws, the scheme of composition is provided for in most State level VAT laws. The conditions prescribed under the GST law for composition scheme is broadly comparable to the conditions / restrictions under the State level VAT laws.

10.4 Issues & concerns

1. While it is clear that a composition supplier is not entitled to effect a supply of services, there is no specific provision in case of a composite supply / a mixed supply which are taxed as supply of goods. Therefore, based on the principles specified in Section 8 of the Act, it may be safe to infer that a supplier opting for composition scheme would be entitled to effect a composite supply containing services, where the principal supply is goods, considering that the **“supply shall be treated as a supply of such principal supply”**. On the other hand, a mixed supply shall be treated as a **“supply of that particular supply which attracts the highest rate of tax”**. Given this position, there is

no clear case for mixed supplies wherein both services and goods contained in the mixed supply suffer the highest rate of tax, from amongst the rates of tax applicable on each of the individual supplies contained in the mixed supply. Due care must be exercised in this regard.

2. An amendment of the rate applicable to the supplies effected by composition suppliers was made with effect from 01.01.2018. In this regard, attention is drawn to the rate applicable to traders which reads as follows – “half per cent of the turnover **of taxable supplies of goods** in the State or Union territory”. It must be noted that the highlighted expression, more specifically, “**of taxable supplies**” is missing in the rate entries applicable to manufacturers and restaurant service providers. Therefore, the said 2 classes of persons would be liable to pay tax on the turnover in State, whether or not the supplies are exempted from tax.

10.5 FAQs

- Q1. Will a taxable person be eligible to opt for composition scheme only for one out of 3 business verticals?

Ans. No. Composition scheme would become applicable for all the business verticals / registrations which are separately held by the person with same PAN.

- Q2. Can composition scheme be availed if the taxable person has inter-State inward supplies?

Ans. Yes. Composition scheme is applicable subject to the condition that the taxable person does not engage in making inter-state outward supplies, while there is no restriction on making any inter-State inward supplies.

- Q3. Can the taxable person under composition scheme claim input tax credit?

Ans. No. Taxable person under composition scheme is not eligible to claim input tax credit.

- Q4. Can the customer who buys from a taxable person who is under the composition scheme claim composition tax as input tax credit?

Ans. No. customer who buys goods from taxable person who is under composition scheme is not eligible for composition input tax credit.

- Q5. Can composition tax be collected from customers?

Ans. No. The taxable person under composition scheme is restricted from collecting tax.

- Q6. What is the threshold for opting to pay tax under the composition scheme?

Ans. The threshold for composition scheme is up to 1.50 crores of aggregate turnover in the preceding financial year.

- Q7. How to compute 'aggregate turnover' to determine eligibility for composition scheme?

Ans. The methodology to compute aggregate turnover is given in Section 2(6). However, since composition scheme is applicable only to suppliers making intra-state supplies, 'aggregate turnover' means 'Value of all taxable supplies (excluding the value of inward

supplies on which tax is payable by a person on reverse charge basis), exempt supplies (except interest income as discussed above), exports of goods or services or both or inter-state supplies of a person having the same PAN (i.e., across India) excluding CGST, IGST, SGST, UGST and cess.

Q8. What does a person having the same PAN mean?

Ans. "Person having the same PAN" means all the units across India having the same PAN as is issued under the Income Tax Law.

Q9. What are the penal consequences if a taxable person is not eligible for payment of tax under the Composition scheme?

Ans. Taxable person who is not eligible for the said scheme, could be imposed penalty as determined under Section 73 or 74.

Q10. What happens if a taxable person who has opted to pay taxes under the composition scheme crosses the threshold limit of `1.50 crores during the year?

Ans. In such case, from the day the taxable person crosses the threshold, the permission granted earlier is deemed to stand withdrawn, and he shall be liable to pay taxes under the regular scheme i.e. section 9, from such day.

10.6 RELEVANT CASE LAWS

1. Vaishno Associates vs. CCE, Jaipur

Assessee classified activity carried out by it under category of 'works contract services' - It claimed benefit of Works Contract Composition Scheme - Adjudicating Authority denied benefit of Composition Scheme on plea that assessee had failed to file any intimation or option to department opting for payment of service tax in respect of works contract under Composition Scheme - Whether denial of benefit of Composition Scheme for sole reason for failure to file intimation prior to payment of service tax was justified - Held, no.

2. ABL Infrastructure (P.) Ltd. vs. CCE, Customs & Service Tax

Assessee was engaged in providing works contract service - It opted to discharge service tax liability under Works Contract (Composition Scheme for Payment of Service Tax) Rules, 2007 - It did not include value of material supplied by service recipient free of cost in gross value of works contract - Whether value of free supply material also be added in gross value of works contract - Held, yes.

Classification and Exemption

Introduction

Unlike Customs law, GST law does not contain a commodity classification tariff, these are contained within the notification which prescribes the rate of tax. Classification, therefore, is an exercise that is inevitable to identify the specific entry in any of the 6 schedules for determining the rate of tax on the supply of goods or services. The revenue department could

object to the rate adopted or exemption claimed when the error is observed at the time of assessment, investigation or revenue audit. This could lead to multiple demands at all stages of supply and also denial of credit. The customer may object to the classification or the rate. The assessee himself may come to know of the error due to competitors using different rates, paying or not paying, attending some awareness session, reading articles, books. Errors may also come to light at the time of due diligence, internal audit, statutory audit, outsourced consultant changing, etc.

Errors in GST classification – Impact

Many assessees could suffer loss of business in period of uncertainty till proper classification is arrived at as they may have adopted some rate for their supplies since they could not afford to stop business for want of HSN. After that they may be following the same incorrect classification unless there is any objection.

The cost of errors would include the following:

1. In case of higher tax being charged, assessee may have to suffer the loss of orders and cost of re-establishing business with the customers, the loss of credibility with customers. The cost of discounts given to retain the customer due to incorrect rate is inevitable.
2. In case of goods or services supplied which are nil rated or exempted the non-availability of credit can be fatal for the business if this claim for exemption is not accurately made by the supplier. In other words, where exemption is availed erroneously, demand for output tax will be made without any facility to allow credit that could have been availed. Similarly, where exemption is omitted to be claimed, there would be a scenario of recovery of input tax credit being ineligible from the start. Demands maybe made at multiple stages of the supply chain. This is a major departure from the earlier regime.
3. In case of short charge due to incorrect classification or claim of exemption which is not available, would result in non-recoverability of taxes from the customers and cost of interest. In business, breaking the credit chain could make business unviable.
4. Valuation methods prescribed for certain categories of goods and or services would be dependent on the classification of such goods and/or services. Wrong classification would lead to wrong payment of tax.
5. On certain goods and/or services GST is to be discharged by the recipient of supply under reverse charge mechanism. Wrong classification may result in non-payment of tax or un-necessary payment of tax.
6. Denial of benefits under FTP such as duty drawback and incentives being provided for various goods and/or services at varied rates can be the result of incorrect classification of goods/services.

7. Non-payment of compensation Cess, if any, applicable on specified goods and or services which may result in penal proceedings over and above the interest liability.
8. Calculating incorrect liability on import of goods / services or not claiming the ITC (Input Tax Credit) benefit of export on goods/service exports due to improper classification could also happen. This could happen when the alternative headings available have different import/export criterion being applicable to them.

In case of revenue raising the short charge or ineligible exemption issues, in addition to the above costs: the cost of penalty, denial of credit availed, cost of dispute resolution at adjudication, appeal, Court stages also would arise. It would also result in internal manpower resources getting substantially involved to resolve the issue inspite of the fact that a specialist in GST may be outsourced to prepare the reply, appearance etc.

Analysis

(i) Classification of Goods or Services:

In order to apply a particular rate of tax, one needs to determine the classification of the supply as to whether the supply constitutes a supply of goods or services or both. Once the same is determined in terms of Section 7 and 8, a further classification in terms of HSN of goods and services has to be made so as to arrive at the rate of tax applicable to the supply. At the outset, it is important to note that HSN for goods are contained in Chapters from 1 to 98 and HSN for Services are contained as Chapter 99 Notified as the 'Scheme of Classification of Services' provided as an Annexure to the Notification issued for rate of tax (CGST) applicable to services (i.e., Annexure to Notification No. 11/2017-Central Tax (Rate) dated 28.06.2017).

The Classification of Goods is older and is based on knowledge gathered from precedents on HSN classification, as an adaptation from that formulated by the World Customs Organisation. The suggested steps for determination of proper classification of goods are as under:

1. The classification of each supply has to be made separately for every individual supply, regardless of the form of supply (such as sale / transfer / disposal including by-products, scraps etc.)
2. Identify the description and nature of the goods being supplied. One must confirm that the product is also more specifically covered in the Customs Tariff. The Section Notes and Chapter Notes specified in the Customs Tariff would squarely apply to the Tariff Schedules under the GST Law, and ought to be read as an integral part of the Tariff for the purpose of classification.
3. If there is any ambiguity, first reference shall be made to the 'Rules of Interpretation' of the First Schedule to the Customs Tariff Act 1975.
 - (a) As per the Rules, first step to be applied is to **find the trade understanding**

of the terms used in the Schedule, if the meaning or description of goods is not clear.

- (b) If the trade understanding is not available, the next step is to **refer to the technical or scientific meaning of the term**. If the tariff headings have technical or scientific meanings, then that has to be ascertained first before the test of trade understanding.
 - (c) If none of the above are available **reference may be made to the dictionary meaning or ISI specifications**. Evidence may be gathered on end use or predominant use.
4. In case of the unfinished or incomplete goods, if the unfinished goods bear the essential characteristics of the finished goods, its classification shall be the same as that of the finished goods.
 5. If the classification is not ascertained as per above point, one has to look for the nature of goods which is more specific.
 6. If the classification is still not determinable, one has to look for the ingredient which gives the goods its essential characteristics.

(ii) **Rate of tax for goods or services**

Purpose of Notification	Supply of Goods	Supply of Services
Prescribing the rate of tax	1/2017-Central Tax (Rate) <i>(As amended from time to time)</i>	11/2017-Central Tax (Rate) <i>(As amended from time to time)</i>
Granting the exemption	2/2017-Central Tax (Rate) <i>(As amended from time to time)</i>	12/2017-Central Tax (Rate) <i>(As amended from time to time)</i>

A screenshot of the website hosted by the Central Board of Indirect Taxes and Customs (CBIC – Source link: <http://www.cbec.gov.in/htdocs-cbec/gst/central-tax-rate-notfns-2017>) containing the list of notifications is provided below:

Central Tax (Rate) Notifications			
Notification No. & Date of Issue	English	हिन्दी	Subject
07/2017-Central Tax (Rate).dt. 28-06-2017	View (254 KB)	देखें (512 KB)	Exemption from CGST supplies by CSD to Unit Run Canteens and supplies by CSD / Unit Run Canteens to authorised customers notified under section 11 (1) and section 55 CSD
06/2017-Central Tax (Rate).dt. 28-06-2017	View (142 KB)	देखें (498 KB)	Refund of 50% of CGST on supplies to CSD under section 55
05/2017-Central Tax (Rate).dt. 28-06-2017	View (269 KB)	देखें (985 KB)	Supplies of goods in respect of which no refund of unutilised input tax credit shall be allowed under section 54 (3)
04/2017-Central Tax (Rate).dt. 28-06-2017	View (263 KB)	देखें (739 KB)	Reverse charge on certain specified supplies of goods under section 9 (3)
03/2017-Central Tax (Rate).dt. 28-06-2017	View (299 KB)	देखें (859 KB)	2.5% concessional CGST rate for supplies to Exploration and Production notified under section 11 (4)
02/2017-Central Tax (Rate).dt. 28-06-2017	View (375 KB) Corrigendum (100 KB) Corrigendum (249 KB), dated 27-07-2017	देखें (856 KB) Corrigendum (100 KB) Corrigendum (234 KB), dated 27-07-2017	CGST exempt goods notified under section 11 (1)
01/2017-Central Tax (Rate).dt. 28-06-2017	View (1508 KB) Corrigendum (252 KB), dated 30-06-2017 Corrigendum (100 KB), dated 12-07-2017 Corrigendum (257 KB), dated 27-07-2017	देखें (3398 KB) Corrigendum (488 KB), dated 30-06-2017 Corrigendum (85 KB), dated 12-07-2017 Corrigendum (333 KB), dated 27-07-2017	CGST Rate Schedule notified under section 9 (1)

Viewing 41 to 47 of 47

<< 1 2 3 4 5 >>

Central Tax (Rate) Notifications			
Notification No. & Date of Issue	English	हिन्दी	Subject
18/2017-Central Tax (Rate) .dt. 30-06-2017	View (139 KB)	देखें (37 KB)	Seek to reduce the rate of Central Tax, Union Territory Tax, on fertilisers from 6% to 2.5% and Integrated Tax rate on fertilisers from 12% to 5%
17/2017-Central Tax (Rate) .dt. 28-06-2017	View (136 KB)	देखें (585 KB)	To notify the categories of services the tax on intra-State supplies of which shall be paid by the electronic commerce operator
16/2017-Central Tax (Rate) .dt. 28-06-2017	View (344 KB)	देखें (385 KB)	To notify specialised agencies entitled to claim a refund of taxes paid on the notified supplies of goods or services or both received by them under CGST Act
15/2017-Central Tax (Rate) .dt. 28-06-2017	View (142 KB)	देखें (431 KB)	To notify the supplies not eligible for refund of unutilized ITC under CGST Act
14/2017-Central Tax (Rate) .dt. 28-06-2017	View (248 KB)	देखें (318 KB)	To notify the supplies which shall be treated neither as a supply of goods nor a supply of service under the CGST Act
13/2017-Central Tax (Rate) .dt. 28-06-2017	View (274 KB)	देखें (722 KB)	To notify the categories of services on which tax will be payable under reverse charge mechanism under CGST Act
12/2017-Central Tax (Rate) .dt. 28-06-2017	View (440 KB)	देखें (990 KB)	To notify the exemptions on supply of services under CGST Act
11/2017-Central Tax (Rate) .dt. 28-06-2017	View (390 KB) Annexure (252 KB)	देखें (1.11 MB) Annexure (252 KB)	To notify the rates for supply of services under CGST Act
10/2017-Central Tax (Rate).dt. 28-06-2017	View (154 KB)	देखें (503 KB)	CGST exemption for dealers operating under Margin Scheme notified under section 11 (1)
09/2017-Central Tax (Rate).dt. 28-06-2017	View (143 KB)	देखें (500 KB)	Exempting supplies to a TDS deductor by a supplier, who is not registered, under section 11 (1)

Viewing 1 to 10 of 18

<< 1 2 >>

(iii) Requirement of Classification

It may seem like classification may not be so cumbersome, and tools such as experience, logic and common sense are sufficient to identify the classification, and to interpret the tariff notifications. However, a quick look at some examples would drive home the need to pay close attention to the principles of classification. Let us consider the following examples:

- (1) a 'watch made of gold' – an article of gold or a watch, albeit an expensive one?
- (2) a confectionary product 'hajmola' – an ayurvedic medicaments or remains confectionary sweets?
- (3) serving of 'brandy with warm water' – classified based on its curative effect on common cold, or dismissed as alcoholic liquor for human consumption?
- (4) surgical gloves – latex products or accessories to healthcare services?

- (5) mirror cut-to-size for automobiles – article of glass or accessories to motor vehicles fitted as rear-view mirror?

As can be seen from the few instances mentioned above, classification is not one that is free from doubt. When coupled with differential rates of tax, the scope for misclassification is bound to be reinforced with motivation to either reduce the tax incidence / or to pay a higher tax to circumvent any possible interest and penalty. Both these motivations can work on either sides – industry as well as tax administration. Classification cannot, therefore, be left to the whims and fancies of each person, and reference must be made to the guidance provided in the law itself.

(iv) Approach to Classification

The notifications prescribing the rate of tax in respect of goods as well as services contain explanations as to how the classification must be undertaken. Extracts of some of those explanations are provided below for ease of reference:

(iii) “Tariff item”, “sub-heading” “heading” and “Chapter” shall mean respectively a tariff item, sub-heading, heading and chapter as specified in the First Schedule to the Customs Tariff Act, 1975 (51 of 1975).

Notification 1/2017-Central Tax (Rate) dated 28 June, 2017

4. *Explanation.*- For the purposes of this notification,-

- (i) Goods includes capital goods.
- (ii) Reference to “Chapter”, “Section” or “Heading”, wherever they occur, unless the context otherwise requires, shall mean respectively as “Chapter”, “Section” and “Heading” in the annexed scheme of classification of services (Annexure).
- (iii) The rules for the interpretation of the First Schedule to the Customs Tariff Act, 1975 (51 of 1975), the Section and Chapter Notes and the General Explanatory Notes of the First Schedule shall, so far as may be, apply to the interpretation of heading 9988.
- (iv) Wherever a rate has been prescribed in this notification subject to the condition that

Notification 11/2017-Central Tax (Rate) dated 28 June, 2017

As can be seen from the above, the notification prescribing the rate of tax itself specifies the approach that is to be followed for purposes of classification, namely:

- (a) in respect of goods, the notification requires reference to be had to the First Schedule to Customs Tariff Act 1975: A quick look at these would help us to recognize the approach that needs to be followed for classification.

1. THE CUSTOMS TARIFF ACT, 1975 (51 Of 1975)¹

(1)

An act to consolidate and amend the law relating to customs duties.

Be it enacted by Parliament in the Twenty-sixth Year of the Republic of India as follows:-

1. (1) This Act may be called the Customs Tariff Act, 1975.

















(2) It extends to the whole of India.

(3) It shall come into force on such date as the Central Government may, by notification in the Official Gazette, appoint. ^{2,3}

2. The rates at which duties of customs shall be levied under the Customs Act, 1962, are specified in the First and Second Schedules,⁴

The above table is an adaptation of the Harmonized System of Nomenclature (HSN) established for aiding in uniformity in Customs classification in international trade between member countries of World Customs Organization. It was drafted under the aegis of Customs Cooperation Council Nomenclature, Brussels. It was adopted for Customs purposes by India in 1975 and readapted (with some changes) for Central Excise in 1985 and now for purposes of GST in 2017. Please bear in mind that reference to the original HSN would be of much help in understanding the scope of any entry to understand the full extent of meaning implied in any entry found while reading Customs Tariff Act. Refer www.wcoomd.org where the HSN is available for purchase or subscription from World Customs Organization.

- (b) in respect of services, the notification requires reference to the Annexure which contains the Scheme of Classification: The Annexure is appended to the CGST rate notification and contains entries under Chapter 99 (although there is no such chapter for services in the HSN prescribed under the Customs Law). Additionally, Explanatory Notes to such classification were recently issued to assist in interpretation of various entries in the Annexure to the rate notification:

Central Tax (Rate) Notifications		
Notification No. & Date of Issue	English	हिन्दी
18/2017-Central Tax (Rate) ,dt. 30-06-2017	View  (136 KB)	देखें  (37 KB)
17/2017-Central Tax (Rate) ,dt. 28-06-2017	View  (136 KB)	देखें  (585 KB)
16/2017-Central Tax (Rate) ,dt. 28-06-2017	View  (344 KB)	देखें  (385 KB)
15/2017-Central Tax (Rate) ,dt. 28-06-2017	View  (142 KB)	देखें  (431 KB)
14/2017-Central Tax (Rate) ,dt. 28-06-2017	View  (248 KB)	देखें  (318 KB)
13/2017-Central Tax (Rate) ,dt. 28-06-2017	View  (274 KB)	देखें  (722 KB)
12/2017-Central Tax (Rate) ,dt. 28-06-2017	View  (440 KB)	देखें  (990 KB)
11/2017-Central Tax (Rate) ,dt. 28-06-2017	View  (399 KB)	देखें  (1.11 MB)
10/2017-Central Tax (Rate),dt. 28-06-2017	View  (143 KB)	देखें  (503 KB)
09/2017-Central Tax (Rate),dt. 28-06-2017	View  (143 KB)	देखें  (500 KB)
Viewing 1 to 10 of 18		

- (v) In this regard, it may also be noted that the tariff entries in case of certain services refer to the rate of tax applicable to the relevant goods. In the following cases of supply of services, the rate of tax applicable as on a supply of like goods involving transfer of title in goods, would be applicable on the supply of services:

Chapter, Section or Heading	Description of Service
Heading 9971 (Financial and related services)	(ii) Transfer of the right to use any goods for any purpose (whether or not for a specified period) for cash, deferred payment or other valuable consideration.
	(iii) Any transfer of right in goods or of undivided share in goods without the transfer of title thereof.
Heading 9973 (Leasing or rental services, with or without operator)	(iii) Transfer of the right to use any goods for any purpose (whether or not for a specified period) for cash, deferred payment or other valuable consideration.
	(iv) Any transfer of right in goods or of undivided share in goods without the transfer of title thereof.
	(vi) Leasing or rental services, with or without operator, other than (i), (ii), (iii), (iv) and (v) above.

The only exception to the above table is leasing of motor vehicle which was purchased by the lesser prior to July 1, 2017, leased before the GST appointed date (i.e., 01.07.2017)

and no credit of central excise, VAT or any other taxes on such motor vehicle had been availed by him. If all these conditions are fulfilled, then the lessor is liable to pay GST only on 65% of the GST applicable on such motor vehicle. – Refer Notification No.37/2017- Central Tax (Rate) dated 13.10.2017.

(vi) Customs Tariff Act – Rules of Interpretation

The rules of interpretation are contained in the Customs Tariff Act provides guidance regarding the approach to be followed for reading and interpreting tariff entries. These rules are merely summarized and listed below for convenience, whereas a detailed study of the rules is advised from commentaries and value-added updated tariff publications. Please refer to full set of Rules of Interpretation at page 28 and 29 of the Customs Tariff Act on <http://www.cbec.gov.in/resources//htdocs-cbec/customs/cst2012-13/cst-act-1213.pdf>

- Rule 1: headings are for reference only and do not have statutory force for classification;
- Rule 2(a): reference to an article in an entry includes that article in CKD-SKD condition;
- Rule 2(b): reference to articles in an entry includes mixtures or combination;
- Rule 3(a): where alternate classification available, specific description to be preferred;
- Rule 3(b): rely on the material that gives essential character to the article;
- Rule 3(c): apply that which appears later in the tariff as later-is-better;
- Rule 4: examine the function performed that is found in other akin goods;
- Rule 5: cases-packaging are to be classified with the primary article;
- Rule 6: when more than one entry is available, compare only if they are at same level.

(vii) Role of 'Manufacture' in Classification

Classification would be well understood by applying the above rules of interpretation. Now, the process that goods are passed through can impact their classification. For example, cutting, slicing and packing pineapple in cans in sugar syrup has primary input of pineapple and the output is canned fruit with extended shelf-life. Now, the input and output are not identical, but it has been held in the case of "*Pio Food Packers*" that this is not a process amounting to manufacture. But, would it be possible to regard the input and the output to retain the same classification. The answer lies in knowing the scope of each entry applicable to classification. Another example, Kraft paper used to make packing boxes may be sold as it is or after laminating them. It has been held in the case of *Laminated Packaging* that this process is manufacture even though the input and

output fall within the same classification entry. GST Law has adopted, in section 2(72), the general understanding of manufacture that is very similar to that in Central Excise. The real test from this definition – is the input and output functionally interchangeable or not in the opinion of a knowledgeable end-user – and not based on the classification entry. Change in classification entry from one to the other, that is, classification entry for input is not the same as that of the output, could only arouse suspicion about the possibility of manufacture. Please note that ‘manufacture’ is included in the definition of ‘business’ (in section 2(17)) but it is not included as a ‘form of supply’ (in section 7(1)(a) or anywhere else). Hence, the nature of the process that inputs are put through may not be manufacture but yet may appear to move the output into a different entry compared to the input. So, would change of classification entry be relevant or degree of change produced in the input due to the process carried out must be considered. With the adoption of HSN based classification from Custom Tariff Act, it is imperative to carefully consider whether one entry has been split and sub-divided into categories even if they both carry the similar rate of tax. Hence, the key aspects to consider are:

- Identify the scope of an entry for classification of input or output
- Study the nature of process carried out on the inputs
- Examine by the ‘test’ (above) if result of the process is manufacture
- Now identify the classification applicable to the output

For example, Is ‘desiccating a coconut’ a process of manufacture? If yes, the desiccated coconut ought not to be considered as eligible to the same rate of tax as coconut. Drying grains may not appear to be a process of manufacture but frying them could be manufacture as the grains are no longer ‘seed grade’ although it resembles the grain.

Manufacture need not be a very elaborate process. It can be a simple process but one that brings about a distinct new product – in the opinion of a knowledgeable end-use – and not just any person with no particular familiarity with the article. Manufacture need not be an irreversible process. It can be reversible yet until reversed it is recognized as a distinct new product, again, in the opinion of those knowledgeable in it. Processes such as assembly may be manufacture in relation to some articles but not in others. So, caution is advised in generalizing these verbs – assembly, cutting, polishing, etc. – but examining the degree of change produced and the identity secured by the output in the relevant trade as to the functional inter-changeability of the output with the input. If a knowledgeable end-use would accept either input or output albeit with some reservation, then it is unlikely to be manufacture. But, if this knowledgeable end-user would refuse to accept them to be interchangeable, then the process carried out is most likely manufacture. Usage of common description of the input and output does not assure continuity of classification for the two.

(viii) Role of ‘Supplier Status’ in Classification

This is best explained with an illustration – a restaurant buys aerated beverage on

payment of GST at 28% +12% including cess and on resale of this beverage as part of food served as a combo with 'composition status' under Section 10 of CGST Act, the rate of tax on this beverage would be 5%. Therefore, it is important to note that classification can undergo a change depending upon the 'status' of the Supplier. Another illustration could be medicaments which are taxed at 5% would be exempt from tax when they are administered by the hospital to casualty/emergency admissions and to in-patients even if billed separately in the invoice issued to patient by the hospital.

(ix) Classification for Exemptions

In GST law the exemptions are set out under section 11 of the whole of the tax payable or a part of it. In granting exemptions, it is not necessary that the exemption be made applicable to the entire entry. In other words, exemption notifications are capable of carving out a portion from an entry so as differentially alter the rate of tax applicable to goods or services within that entry. Exemptions can take any of the following forms:

- Supplier may be exempt – here, regardless of the nature of outward supply, exemption apply to the supplier. Conditions specified may make such exemption be applicable to the supplier but when the supplies are made to specified recipients

Sl. No.	Chapter, Section, Heading, Group or Service Code (Tariff)	Description of Services	Rate (per cent.)	Condition
(1)	(2)	(3)	(4)	(5)
1	Chapter 99	Services by an entity registered under section 12AA of the Income-tax Act, 1961 (43 of 1961) by way of charitable activities.	Nil	Nil

- Supplies may be exempt – here, the supplier is not as relevant and all supplies that are notified would enjoy the exemption. Conditions specified may help to determine the supplies that are to be allowed the exemption.

28	Heading 9971	Services by way of— (a) extending deposits, loans or advances in so far as the consideration is represented by way of interest or discount (other than interest involved in credit card services); (b) <i>inter se</i> sale or purchase of foreign currency amongst banks or authorised dealers of foreign exchange or amongst banks and such dealers.	Nil	Nil
----	--------------	--	-----	-----

(x) Role of 'Conditions' in Exemptions

It is well understood that conditions in exemption notifications tend to convert the exemption into an option, that is, the exempted / concessional rate of tax would apply when the conditions are fulfilled and by deviating from the conditions, the full rate of tax would apply. This principle has been tested in the context of Section 5A of the Central Excise Act. However, a quick look at the Explanation to Section 11 of the CGST Act (reproduced below) appears to indicate that unless an express option is granted in the exemption notification, the concessional or exempted rate of tax along with attendant conditions must be availed without any discretion to opt out of it.

Explanation.—For the purposes of this section, where an exemption in respect of any goods or services or both from the whole or part of the tax leviable thereon has been granted absolutely, the registered person supplying such goods or services or both shall not collect the tax, in excess of the effective rate, on such supply of goods or services or both.

While there may be alternate views that the above explanation applies only when the exemption is 'granted absolutely' and not in all cases, such a view may find the contradiction where one entry in an exemption notification prescribes a concessional rate of tax that applies its restriction on input tax credit, while another entry in the very same notification prescribes two rates of tax where one of them enjoins restriction on input tax credit.

And the reason for resisting the view that – exemption with the condition is an option – is when the Government felt free to specify two alternate tax consequences in respect of a given entry in one case (GTA, in above illustration), there is no justification to make an assumption about the existence of an option even when in the very same notification that government opted to notify only one tax consequence. Accordingly, it would be a reasonable construction that – exemption is a condition is not an option – and all court decisions under earlier laws to the contrary are rendered otiose in view of the explanation to section 11.

Illustration below shows a style where exemption would 'not be option':

Sl No.	Chapter, Section or Heading	Description of Service	Rate (per cent.)	Condition
(1)	(2)	(3)	(4)	(5)
8	Heading 9964 (Passenger transport services)	(i) Transport of passengers, with or without accompanied belongings, by rail in first class or air conditioned coach.	2.5	Provided that credit of input tax charged in respect of goods used in supplying the service is not utilised for paying central tax or integrated tax on the supply of the service

The following illustration is a style of drafting exemption entries that is 'not optional':

Sl No.	Chapter, Section or Heading	Description of Service	Rate (per cent.)	Condition
(1)	(2)	(3)	(4)	(5)
		[[vi) Transport of passengers by any motor vehicle designed to carry passengers where the cost of fuel is included in the consideration charged from the service recipient.	2.5	Provided that credit of input tax charged on goods and services used in supplying the service, other than the input tax credit of input service in the same line of business (i.e. service procured from another service provider of transporting passengers in a motor vehicle or renting of a motor vehicle), has not been taken. [Please refer to Explanation no. (iv)]
			6	or
		(vii) Passenger transport services other than (i), (ii) (iii), (iv), (v) and (vi) above.	9	-]

(xi) Composite Supply vs. Mixed Supply

Reference can also be made to the discussion on Composite Supply and Mixed Supply which can assist in classification of the supply into goods based on the principal supply in a transaction or that part of the transaction which carries the highest rate

(xii) CGST Amendment Act, 2018

The CGST Act, 2017 has been retrospectively amended from July 1, 2017 to provide that transactions covered under Schedule II are not supplies but if they qualify as supplies then such transactions are to be 'treated' for the purpose of determining the relevant rate notification, HSN Code, Time of Supply, Place of Supply and other consequential implications.

(xiii) Classification of Works Contract

Schedule II provides that works contract would be taxed as services and hence irrespective of the value of goods involved in the contract, works contract would be treated as services. Works Contract has been defined at Section 2(119) of the CGST Act to provide that construction, commissioning, fabrication etc related to immovable property would only be treated as works contract. Thus, any activity related to movable property though understood as works contract under the erstwhile laws would not be treated as works contract under the GST law and will have to be classified based on the concept of composite supply

(xiv) Conclusion

In light of the foregoing discussion, the following points of learning can be summarized:

- (a) transactions involving goods are, in certain cases, required to be treated as supply of services. As such, the fundamental classification to be undertaken is the differentiation between goods and services;
- (b) classification of goods and services cannot be made based on logic, experience or common sense. But, recourse to rules of interpretation in the first schedule to Customs Tariff Act is mandatory in relation to classification of goods. And reference to the scheme of classification (contained in the annexure) is inevitable in relation to classification of services. There can be no interchange in the use of the relevant classification rules between goods and services;
- (c) classification in GST requires a deep appreciation of the technical understanding of words and phrases in each domain and any urge to use the common meaning of such words and phrases must be actively discouraged. In other words, even if the common meaning of certain words and phrases appears reasonable, it must be understood that government has deliberately and mindfully words that each and in the case and specific interpretation in the relevant trade;
- (d) classification is not only required to determine the rate of tax applicable but also examine the availability of exemptions. There is no compulsion for an exemption notification to exempt" correctly what is the carveout from an entry a subset of transactions – supplies or suppliers – to attract a different rate of tax;
- (e) exemptions are not optional as are the conditions prescribed in respect of such exemption. Violation of the condition contracts consequences and not options.

'Absolutely exempt' does not mean 'wholly exempt' and it does not require to be 'unconditionally exempt' to be 'absolutely exempt'.

Common Errors in Classification

The errors/ deliberate action which could lead to exposure should the extent possible be avoided. The errors would include many some of them illustrated below:

- (i) Classifying the supply for lower rate of GST without merit- This maybe due to competition or due to fact that the buyer is unable to avail the credit.
- (ii) Classifying the supply under higher slab to avoid dispute – Though there may not be any demand- customer may have some objection and raise a debit note in future. It lead to higher working capital
- (iii) Classifying under wrong heading considering applicability of the same rate- This may not have any commercial impact as there is no rate difference. However when the rate changes there may be a problem.
- (iv) Classifying the supplies based on convenience of operation – This may not be advisable as it is bound to lead to disputes for self as well as the customers.
- (v) Classifying the supplies incorrectly to claim of exemption – This would also be disastrous as demands if any can cripple the enterprise.
- (vi) Classifying the services considering the place of supply to claim as export etc – This can lead to a) demand for GST as supply is liable b) denial of credit due to time lapse or if longer period invoked and c) Demand for excess refund with interest and penalties.
- (vii) Similar to above classifying differently to avoid Reverse charge mechanism. – This could also lead to demand.
- (viii) Classifying under residuary entry when specific entry or general entry is available.

Illustrative rulings by Authority for Advance Rulings relevant for classification of goods/services

1. AUTHORITY FOR ADVANCE RULINGS, DAMAN, DIU AND DNH in case of Western Cable Engineering (P.) Ltd.

Classification of goods (NR) - Heat shrinkable cable jointing kits - Applicant-company is engaged in clearing of their manufactured good, 'Heat Shrinkable Components' under Chapter 854790 in existing law, i.e., under Central Excise Tariff Act, 1985 and were paying duty at rate of 12.5 per cent - However, in GST regime, they have changed their classification and started clearing their goods under Chapter 854690 - Whether since with introduction of GST law, no change is effected in basic characteristics of said product a sudden change in their classification without having legal and reasonable backing is not tenable and, thus, Heat Shrinkable Cable Jointing Kits assembled from various components is to be classified under HS 8547 - Held, yes [Para 5] [In favour of revenue

2. AUTHORITY FOR ADVANCE RULINGS, MAHARASHTRA in case of Shree Construction,

Classification of services (NR) - Works contract services to main contractor - Whether sub-contractor providing works contract services by way of construction, erection, commissioning, or installation to main contractor in respect of original contract works pertaining to railways would be covered for concessional rate of GST at rate of 12 per cent as given under Serial No. 3 of Notification No. 11/2017 as amended - Held, yes [Para 5] [In favour of assessee]

3. AUTHORITY FOR ADVANCE RULINGS, HARYANA in case of Epcos India (P.) Ltd

Classification of goods (NR) - Battery for mobile handset - Whether product 'Battery for Mobile Handset', whether it be separable or non-separable i.e., whether it be detachable or non-detachable, when sold to mobile handset manufacturers who use same to make mobile handset, form part of mobile handset, will qualify to be classified under heading 85 having description 'Parts for manufacture of telephones for cellular networks or for other wireless networks' attracting GST Rate of 12 per cent - Held, yes - Whether product 'Battery for Mobile Handset', when sold to customers other than mobile handset manufacturers who does not use same in manufacture of mobile handset, will qualify to be classified under heading 8507 having description Electric accumulators, including separators thereof, whether or not rectangular (including square), attracting GST at rate of 28 per cent - Held, yes [Para 5] [In favour of applicant].

4. AUTHORITY FOR ADVANCE RULINGS, UTTARAKHAND in case of Ginni Filament Ltd.-

Whether wet baby wipes consist of wadding felt and non-woven fabric coated or covered with perfume or cosmetic and falls under HSN 3307, taxable at 18 per cent GST under Notification No. 41/2017-Central Tax (Rate) - Held, yes - Whether since, basic nature and working of product wet face wipes is almost same as that of wet baby wipes i.e. gently cleaning skin by removing dirt and moistening it and on comparing basic functions of ingredients which is coated in form of lotion over non-woven fabric in respect of wet baby wipes, accordingly same are also classified under HSN 3307 - Held, yes - Whether as regards classification of bed and bath towels also it is observed that basic nature and working of product is almost same as that of wet face wipes, i.e., gently cleaning skin by removing dirt and moistening it; therefore, same merits classification under HSN 3307 - Held, yes

II. Classification of goods (NR) - Shampoo towels - Product shampoo towel consists of non-woven spun lace fabric of 40-60 grams per square meter of standard size 300 mm x 240 mm - Basic function of shampoo towels is to clean and shampoo hair which may be used for a bed-ridden person or who requires partial assistance - Product in question has undergone a process which makes it a preparation for use on hair - Package of shampoo towels indicate that it is meant for application on hair and said product is indeed manufactured for use on hair only - Whether thus, product 'shampoo towel', merits

classification under Chapter 3305 and rate of GST applicable on said product is 18 per cent - Held, yes

5. AUTHORITY FOR ADVANCE RULINGS, WEST BENGAL in case of MD Mohta

Whether 'Rakhi' is an independently identifiable product which may be made up of innumerable materials of no fixed or predetermined ratio, and yet retain its specific identity as a symbol of a bond involving potential care of sister by brother, and not merely an assemblage of discrete materials - Held, yes - Whether Rakhi cannot be termed as a 'handicraft' item under GST under Notification No 32 of 2017-Central Tax dated 15-9-2017 - Held, yes - Whether Rakhi's, which applicant intends to manufacture will not be restricted to mere yellow and red yarn of 'Kalava', hence, Rakhi is not purely puja samagri and will not attract NIL rate of duty under Serial No 92(2) of TRU Clarification - Held, yes - Whether applicant has to classify 'Rakhi' as per its constituent materials in accordance with rule 3(c) of Rules for Interpretation of Customs Tariff Act, 1975, as laid down in Explanatory Notes (iv) of Notification No. 1 of 2017-CT(Rate), dated 28-6-2017 attracting GST in accordance to its classification and exemption under Notification No. 2 of 2017-Central Tax (Rate), dated 28-6-2017 is not applicable for 'Rakhi' - Held, yes

Conclusion

The proper classification is the foundation to avoid disputes with customers as well as demands from the revenue. The applicability of rates (which have changed in between) and exemptions (have been notified and withdrawn) requires the updated knowledge as well as the information of the past changes. Readers may refer to value added GST Tariff reckoners and commentaries to avoid mistakes.

Statutory Provisions

11. Classification and Exemption

- (1) *Where the Government is satisfied that it is necessary in the public interest so to do, it may, on the recommendations of the Council, by notification, exempt generally, either absolutely or subject to such conditions as may be specified therein, goods or services or both of any specified description from the whole or any part of the tax leviable thereon with effect from such date as may be specified in such notification.*
- (2) *Where the Government is satisfied that it is necessary in the public interest so to do, it may, on the recommendations of the Council, by special order in each case, under circumstances of an exceptional nature to be stated in such order, exempt from payment of tax any goods or services or both on which tax is leviable.*
- (3) *The Government may, if it considers necessary or expedient so to do for the purpose of clarifying the scope or applicability of any notification issued under sub-section (1) or order issued under sub-section (2), insert an explanation in such notification or order, as the case may be, by notification at any time within one year of issue of the*

notification under sub-section (1) or order under sub-section (2), and every such explanation shall have effect as if it had always been the part of the first such notification or order, as the case may be.

Explanation.—For the purposes of this section, where an exemption in respect of any goods or services or both from the whole or part of the tax leviable thereon has been granted absolutely, the registered person supplying such goods or services or both shall not collect the tax, in excess of the effective rate, on such supply of goods or services or both.

11.1 Introduction

This provision confers powers on the Central Government to exempt either absolutely or conditionally goods or services or both of any specified description from whole or part of the central tax, on the recommendations of the Council. It also confers power on the Central Government to exempt from payment of tax any goods or services or both, by special order, on recommendation of the Council.

11.2 Analysis

The Central or the State Governments are empowered to grant exemptions from tax, subject to the following conditions:

- (i) Exemption should be in public interest;
- (ii) By way of issue of notification;
- (iii) On recommendation from the Council;
- (iv) Absolute / conditional exemption may be for any goods and / or services of any specified description. In this regard, it may be noted that the exemption would be in respect of the supply and not specifically for any classes of persons. E.g.: An absolute exemption could be granted in respect of supply of water. Whereas, a conditional exemption could be granted for supply of goods to canteen stores department.
- (v) Exemption by way of special order (and not notification) may be granted by citing the circumstances which are of exceptional nature.
- (vi) The GST Law specifies that a registered person supplying the goods and / or services is not entitled to collect a tax higher than the effective rate, where the supply enjoys an absolute exemption.

Effective date of the notification or special order:

The effective date of the notification or the special order would be date which is so mentioned in the notification or special order. However, if no date is mentioned therein, it would be:

- Date of its issue for publication in the official gazette;
- Date on which it is made available on the official website of the Government Department.

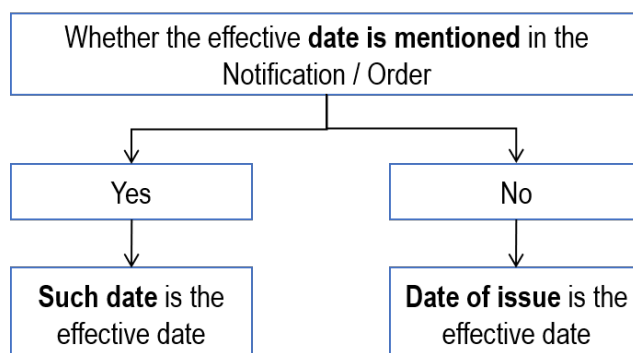

The analysis of above provision in a pictorial form is summarised as follows:

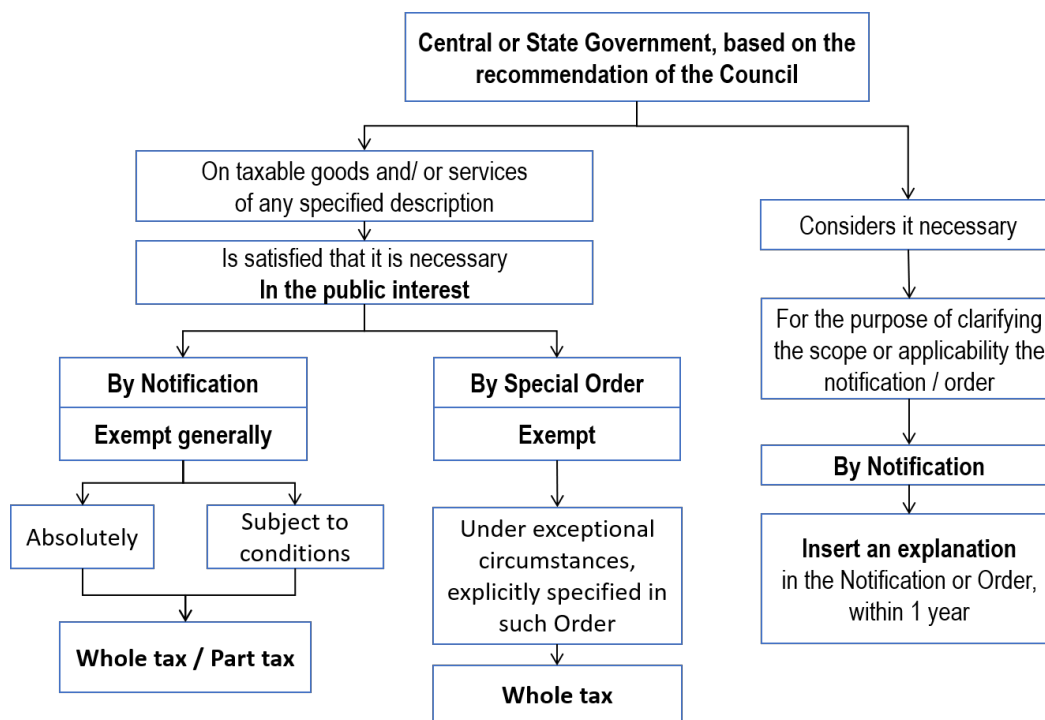

Exemption under one GST Law and the effect on another GST Law:

An exemption issued under the CGST Act will ‘automatically’ exempt the same supply from the levy of tax under the SGST/UTGST Act. This is provided under the SGST/UTGST Act. But the converse is not necessarily applicable, that is, exemption under an SGST/UTGST Act will not exempt levy of tax under the CGST Act.

Exemption under CGST Act	Deemed to be exempt under SGST Act
	Deemed to be exempt under UTGST Act
	No auto-application of exemption under IGST Act
Exemption under IGST Act	No auto-application of exemption under CGST Act

Clarification on a Notification / Special Order

The law also provides for the Government to embed a clarification to such notification or special order, by way of an "Explanation", at any time within a period of 1 year from the date of the said notification or special order. Such explanation inserted within the timelines would have a retrospective effect, viz., from the effective date of the relevant notification or special order.

Section 11 – Illustrations

1. Absolute exemption: Exemption to following taxable services from tax leviable thereon:
 - Services by way of renting of residential dwelling for use as residence.
 - Services by Reserve Bank of India.
 - Services by a veterinary clinic in relation to health care of animals or birds.

Notification No. 12/2017 - Central Tax (Rate) dt.28.06.2017

2. Conditional Exemption: The Central Government has exempted the tax payable under the CGST/ UTGST/ IGST Acts by any taxable person on supply of "Services by a hotel, inn, guest house, club or campsite, by whatever name called, for residential or lodging purposes, having declared tariff of a unit of accommodation less than ` 1000/- per day".

Notification No. 12/2017 - Central Tax (Rate) dt.28.06.2017

3. Conditional, partial exemption: Intra-State supplies of goods or services or both received by a registered person from an unregistered person is exempted from payment of tax under reverse charge provided the aggregate value of such supplies received by a registered person from all or any of the suppliers does not exceed ` 5000/- in a day.

Notification No. 08/2017-Central Tax (Rate) dated 28.06.2017 (Please note that this Notification has been amended various number of times vide various notifications. Presently the above said exemption has been extended till 30.09.2019).

Glimpse of notifications issued for exemption from payment of tax

Notification No.	Particulars	Comments
02/2017 - Central Tax (Rate) dated 28.06.2017	Exempted supplies of around 149 items of goods in terms of Section 11(1) of the CGST Act, 2017. Ex. Electricity, Salt, fresh fruits, plastic bangles, passenger baggage etc. Amended vide Notification No. 28/2017, 35/2017, 42/2017, 7/2018 - Central Tax (Rate)	The notification was issued in exercise of powers conferred u/s 11(1). The notification was made applicable retrospectively w.e.f 01.07.2017. The said notification has been amended various number of times to include as well as exclude various items from the notification.

Notification No.	Particulars	Comments
Notification No. 03/2017-Central Tax (Rate) dated 28.06.2017	Goods specified in the List annexed required in connection with various kinds of petroleum operations undertaken are given concessional rate i.e. at the rate of 2.5% under CGST i.e. 5% IGST.	Although petroleum products are outside the purview of GST. But, the notification seeks to provide a concessional rate of tax supplies relating to petroleum operations.
Notification No. 07/2017-Central Tax (Rate) dated 28.06.2017	Exemption to supplies by CSD to Unit Run Canteens and supplies by CSD / Unit Run Canteens to authorised customers	The notification came into effect retrospectively w.ef.01.07.2017
Notification No. 08/2017-Central Tax (Rate) dated 28.06.2017	Exemption granted from levy of CGST under RCM on supplies received from unregistered persons. (if value of supplies does not exceed ` 5000 from any or all the suppliers in a day) Amended vide Notification No. 38/2017 and 10/2018-Central Tax (Rate) Scope of this exemption has been enhanced to all supplies without any monetary limit, by way of an amendment, upto 31.06.2018.	Exemption in respect of all supplies has been granted up to 31.03. 30.09.2019 by Notification No.22/2018 dated.06.08.2018. However, given that a notification corresponding to Notification No.08/2017 is missing in the IGST Law, it may be understood that all inter-State supplies remain taxable under Section 5(4) of the IGST Act, 2017 upto 13.10.2017, from which date, all supplies, without any monetary limit, are exempt upto 30.09.019.
Notification No. 09/2017-Central Tax (Rate) dated 28.06.2017	Exemption granted to supplies to a TDS deductor by a unregistered supplier	This exemption notification is not available under IGST (Rate).
Notification No. 10/2017 - Central Tax (Rate) dated 28.06.2017	Exemption to Supplies of second hand goods received by registered person dealing in buying & selling of second hand goods from unregistered person provided the dealer pays central tax on supply of such second-hand goods as per CGST Rules	This exemption notification is not available under IGST (Rate).

Notification No.	Particulars	Comments
Notification No. 12/2017-Central Tax (Rate) dated 28.06.2017	Exemption to supply specified services under the CGST Act. Almost, all the exemptions were available earlier under the erstwhile regime also under service tax Amended vide Notification No. 21/2017, 25/2017, 32/2017 and 47/2017, 2/2018 - Central Tax (Rate)	The notification contains nearly 79 entries exempting various supply of services from GST. The notification has been amended various number of times either to include or exclude various services from the exemption.
Notification No.26/2017-Central Tax (Rate) dated.21.09.2017	Exemption to supply of heavy water and nuclear fuels falling in Chapter 28 of the First Schedule to the Customs Tariff Act, 1975 (51 of 1975) by the Department of Atomic Energy to the Nuclear Power Corporation of India Ltd	The Exemption notification provided absolute exemption from whole of the Tax Payable.
Notification No.30/2017-Central Tax (Rate) dated.29.09.2017	Exempting supply of services associated with transit cargo to Nepal and Bhutan	The notification was issued as an amendment of Notification No.12/2017.
Notification No.5/2018-Central Tax (Rate) dated 25.01.2018	Exempting the Central Government's share of Profit Petroleum as defined in the contract entered into by Central government in this behalf	
Notification No.18/2017-Integrated Tax (Rate) dated 05.07.2017	Exemption from IGST to SEZs on import of Services by a unit/developer in an SEZ	Corresponding Notification would not apply in case of intra-State supplies, given that all supplies by SEZ are inter-State supplies

11.3 Comparative review

The provisions relating to exemption are broadly similar to the exemption provisions under the erstwhile tax regime. There are no significant differences.

11.4 Issues and concerns

1. The law provides that tax shall not be collected at a rate higher than the effective rate of tax applicable on a supply enjoying an absolute exemption. In this regard, there is one

school of thought wherein it is inferred that this provision is specific to absolute exemptions only, and in case of conditional exemptions, there is an option available to the registered supplier to collect tax from a recipient (Such a methodology, if adopted by suppliers, would imply that the requirement for input tax credit reversals under Section 17(2) of the Act would not stand attracted). The other view is that the conditional exemptions are not optional, but are mandatory when the conditions relating to the exemption are satisfied.

2. On similar lines, it is to be noted that the restriction imposed by law is upon the "collection" of tax. Therefore, certain registered suppliers may resort to payment of tax without collection thereof, in order to effect only taxable supplies whereby they would not be required to undergo the hassle of reversal of input taxes. However, the issue would arise as regards the documentation. A registered supplier may consider issuing a tax invoice instead of a bill of supply, against a supply that is wholly exempt, and specifying in the tax invoice prominently, that the recipient is not required to pay the tax charged on the invoice on the basis that the supply is exempted under law. However, this practice is frowned upon, as this methodology is not entirely in compliance with the provisions of the law. It is also important to note that the GST Law casts an obligation on the supplier to prove that he has not collected taxes in such situations.

11.5 Relevance of Section 11 in GSTR-9, 9A and 9C

1. Pt. 5D of GSTR-9 requires details comprising of Taxable Value, CGST, SGST, IGST and Cess as applicable, in respect of "Exempted Outward Supplies". Further, the instructions annexed to the form also clarify that Table 8 of Form GSTR-1 may be used for filling up the above-mentioned details.
2. Pt. 6B of GSTR-9A also requires details comprising of Turnover, Rate of Tax, CGST, SGST, IGST and Cess as applicable, in respect of "Exempted Outward Supplies" as declared in returns filed during the financial year.
3. Pt. 7B of GSTR-9C requires the value of **Exempted**, NIL Rated, Non-GST supplies, No Supply turnover. Further, the instructions annexed to the form contain a clarification that the figure so reported shall be net of credit notes, debit notes and amendments if any.

11.6 FAQs

- Q1. When exemption from whole of tax leviable on goods and/or services has been granted unconditionally, can taxable person collect tax?
- Ans. No, the taxable person providing goods and/or services shall not collect the tax on such goods and/or services in respect of those supplies which are notified for absolute exemptions.
- Q2. Under what circumstances can a special order be issued?

Ans. The Government may in public interest, issue a special order on recommendation of GST council, to exempt from payment of tax, any goods and/or services on which tax is leviable. The circumstances of exceptional nature would also have to be specified in the special order.

Q3. What shall be the effective date in case of issue of notification?

Ans. The Notification shall be effective from the date as mentioned in the notification. However, in case no date is mentioned in the notification the effective date shall be the date of issue of the notification.

11.7 MCQs

Q1. Which of the following can be issued by Central Government/ State Government to exempt goods and/or services on which tax is leviable in exceptional cases?

- (a) Exemption Notification
- (b) Special order
- (c) Other notifications
- (d) None of the above

Ans. (b) Special Order

Chapter 4

Time of Supply

Sections	Rules
12. Time of supply of goods	Nil
13. Time of supply of services	
14. Change in rate of tax in respect of supply of goods or services	

Statutory Provisions

<p>12. Time of supply of goods</p> <p>(1) The liability to pay tax on goods shall arise at the time of supply, as determined in accordance with the provisions of this section.</p> <p>(2) The time of supply of goods shall be the earlier of the following dates, namely: —</p> <p>(a) the date of issue of invoice by the supplier or the last date on which he is required, under sub-section (1) of section 31, to issue the invoice with respect to the supply; or</p> <p>(b) the date on which the supplier receives the payment with respect to the supply:</p> <p>Provided that where the supplier of taxable goods receives an amount up to one thousand rupees in excess of the amount indicated in the tax invoice, the time of supply to the extent of such excess amount shall, at the option of the said supplier, be the date of issue of invoice in respect of such excess amount.</p> <p><i>Explanation 1.</i>—For the purposes of clauses (a) and (b), “supply” shall be deemed to have been made to the extent it is covered by the invoice or, as the case may be, the payment.</p> <p><i>Explanation 2.</i>—For the purposes of clause (b), “the date on which the supplier receives the payment” shall be the date on which the payment is entered in his books of account or the date on which the payment is credited to his bank account, whichever is earlier.</p> <p>(3) In case of supplies in respect of which tax is paid or liable to be paid on reverse charge basis, the time of supply shall be the earliest of the following dates, namely: —</p> <p>(a) the date of the receipt of goods; or</p>

¹ Omitted vide The Central Goods and Services Tax Amendment Act, 2018 w.e.f. 01.02.2019

- (b) *the date of payment as entered in the books of account of the recipient or the date on which the payment is debited in his bank account, whichever is earlier; or*
- (c) *the date immediately following thirty days from the date of issue of invoice or any other document, by whatever name called, in lieu thereof by the supplier:*

Provided that where it is not possible to determine the time of supply under clause (a) or clause (b) or clause (c), the time of supply shall be the date of entry in the books of account of the recipient of supply.

- (4) In case of supply of vouchers by a supplier, the time of supply shall be—
- (a) the date of issue of voucher, if the supply is identifiable at that point; or
- (b) the date of redemption of voucher, in all other cases.
- (5) Where it is not possible to determine the time of supply under the provisions of sub-section (2) or sub-section (3) or sub-section (4), the time of supply shall—
- (a) in a case where a periodical return has to be filed, be the date on which such return is to be filed; or

(b) in any other case, be the date on which the tax is paid.

- (6) The time of supply to the extent it relates to an addition in the value of supply by way of interest, late fee or penalty for delayed payment of any consideration shall be the date on which the supplier receives such addition in value.

Relevant circulars, notifications, clarifications issued by Government

1. Notification No. 9/2017 – Central Tax dated 28.06.2017 Seeks to appoint 01.07.2017 as the date on which the provisions of Section 12 are effective.
2. Notification No. 66/2017 – Central Tax dated 15.11.2017 Seeks to exempt all taxpayers from payment of tax on advances received in case of supply of goods (*This notification is issued superseding the earlier Notification No. 40/2017 – Central Tax dated 13.10.2017 wherein the exemption from payment of tax on receipt of advances was extended to a registered person whose aggregate turnover is less than ₹ 1.5 crores*);
3. Notification No. 4/2017 – Central Tax (Rate) dated 28.06.2017 Specifies goods the supply of which is liable to CGST under reverse charge mechanism;
4. Notification No. 8/2017 – Central Tax (Rate) dated 28.06.2017 Exemption from payment of CGST under reverse charge for supplies where value do not exceed ₹ 5,000/-;
5. Notification No. 10/2017 – Central Tax (Rate) dated 28.06.2017 CGST exemption for dealers in buying and selling second hand goods operating under margin scheme;

6. Notification No. 38/2018 – Central Tax (Rate) dated 13.10.2017 exempt payment of tax under section 9(4) of the CGST Act, 2017 till 31.03.2018;
7. Notification No. 10/2018 – Central Tax (Rate) dated 23.03.2018 exempt payment of tax under section 9(4) of the CGST Act, 2017 till 30.06.2018.
8. Notification No. 12/2018 – Central Tax (Rate) dated 29.06.2018 exempt payment of tax under section 9(4) of the CGST Act, 2017 till 30.09.2018.
9. Notification No. 22/2018 – Central Tax (Rate) dated 06.08.2018 exempt payment of tax under section 9(4) of the CGST Act, 2017 till 30.09.2019.
10. Notification No. 1/2019 – Central Tax (Rate) dated 29.01.2019 which rescinds Notification No. 8/2017-Central Tax (Rate), dated 28.06.2017, in view of bringing into effect the amendments (regarding RCM on supplies by unregistered persons) in the GST Acts payment of tax under section 9(4) of the CGST Act, 2017 till 30.09.2019.
11. Circular No. 38/12/2018 dated 26.03.2018 clarify the levy of GST, time of supply of goods and value of supply in case of goods sent for job-work.
12. CBIC Circular No. 22/22/2017-GST, dated 21-12-2017 clarify issues regarding treatment of supply by an artist in various States and supply of goods by artists from galleries
13. CBIC Circular No. 10/10/2017-GST, dated 18-10-2017 clarify issues wherein the goods are moved within the State or from the State of registration to another State for supply on approval basis

Related provisions of the Statute

Section or Rule (CGST / SGST)	Description
Section 2(31)	Definition of Consideration
Section 2(41)	Definition of Document
Section 2(52)	Definition of Goods
Section 2(66)	Definition of Tax Invoice or Invoice
Section 2(93)	Definition of Recipient
Section 2(97)	Definition of Return
Section 2(98)	Definition of Reverse Charge
Section 2(105)	Definition of Supplier
Section 2(118)	Definition of voucher

Section 7	Scope of Supply
Section 9	Levy and Collection
Section 14	Change in rate of tax in respect of supply of goods or services
Section 15	Value of taxable supply
Section 31	Tax invoice, credit note and debit note
Section 39	Furnishing of Returns

12.1 Analysis

(a) Introduction

Supply has been understood to hold the key to the incidence of GST, but it is the 'time of supply' that dictates the occasion when this incidence will come to rest. Taxable supply has been defined to mean a supply of goods and/or services which is chargeable to tax under this Act. It is interesting to note the use of the expression 'chargeable to tax' as opposed to 'leviable to tax'. It has been held that 'chargeable to tax' encompasses not only the incidence of tax but also its assessment.

The opening words in section 12(1) are very interesting and forceful as it is here that the liability to pay GST arises. The subject matter of levy – goods or services – becomes encumbered with the tax upon occurrence of the taxable event – supply. But the tax levied in terms of section 9, comes to reside only at the time determined by section 12 and 13. Accordingly, these sections play a stellar role in the imposition of GST.

The provisions state that the time of supply "shall be" and as such is a "must" to be examined closely. It signifies that "time of supply" is not a fact to be inquired by the taxable person but one that is to be admitted as the time of supply appointed by the will of legislature as declared in the section. In order to not allow any opportunity for a suggestion by the taxable person or even the tax administration as to any alternative to what could be the time of supply, the legislature retains for itself the exclusive authority to appoint the time of supply by employing the words "shall be". Therefore, the time of supply is what is stated in the law to be the time of supply and nothing else.

Invoice is commonly understood as 'proof of sale' but this common understanding is far from the truth. Invoice is a document recording the terms of an arrangement already entered. Lease agreement, as an analogy, is a document in present evidencing the agreement reached between two parties is for the lease of property for certain duration in exchange for a certain consideration. A lease arrangement verbally entered into previously when documented by an indenture or deed does not bring into existence the lease when the document is prepared. In fact, the document merely is a record of an arrangement of lease entered previously, *albeit* verbally. Verbal arrangements are no less agreements in the eyes of law. Similarly, an invoice does not bring into existence a sale agreement but merely records the terms of whatever arrangement that may have been entered into by the parties, involving the subject matter. Tax

laws require the preparation of an invoice not as if the absence of an invoice defeats the levy but prescribes an unambiguous occasion when the tax may become recoverable with a proper record of the terms of the underlying arrangement. Therefore, an invoice can evidence not only a sale but every other form of supply such as transfer, barter, exchange, license, rental, lease or disposal. If issuance of an invoice is uncommon for barter or a rental arrangement, then it is to do with our own unfamiliarity and nothing to do with its impermissibility.

(b) Time of Supply – Forward Charge

Time of supply is prescribed (legislative will) to be the earlier of (a) date of issue of invoice or last date on which the invoice is required to be issued with respect to the supply and (b) date of receipt of payment. Date of issue of invoice requires us to examine section 31 which deals with the requirement to issue a “tax invoice”. Here two kinds of situations are contemplated, namely:

- (i) A case where the supply involves movement of goods
- (ii) Any other case

Before proceeding, it is necessary to admit the concept of ‘person and taxable person’. Person is defined in the most familiar manner in section 2(84) but taxable person is explained in detail in section 25 (please refer to the relevant Chapter for a detailed discussion). A proper reading of section 25 helps us understand – a State is the smallest registrable unit in GST – except where multiple business verticals are registered separately under section 25. A taxable person is, therefore, the presence of the person in a State where taxable supplies are made from in the name of such person. When a person becomes liable to be registered in a State at any place from where taxable supplies are made therein, every place in that State such person shall be a taxable person.

Now, we may return to our discussion regarding the two kinds of cases that are discussed on time of supply. It is noticeable that section 31 uses two expressions – ‘removal of goods’ and ‘movement of goods’ – which are not merely expressions of distinction without a difference. There is deliberate purpose for legislating in this manner. ‘Removal of goods’ is defined in section 2(96) and identifies the steps that may follow once the decision to supply is made. But, ‘movement of goods’ is not defined and is, therefore, an attribute of the goods at the time of supply.

Illustration 1: Machine tools on display at an exhibition in Mumbai agreed to be purchased by executives of an engineering company from Indore attending the exhibition, is a case of ‘supply involving movement’ even though the transportation is undertaken by representatives of the purchaser on their own.

Illustration 2: In illustration 1 above, if the executives from Indore were to place an order at the same exhibition with instructions for delivery to be ensured by the exhibitor (supplier) assured within six weeks, this would also be a case of ‘supply involving movement’ and the transportation being organised by the supplier through an independent transport agency from the factory or exhibitor site to the customer location.

It is for this reason that the language employed of seemingly similar or synonymous expressions – ‘removal of goods’ and ‘movement of goods’ – but demands to be supplied their separate and individual meanings and not be misled by their apparent similarity. To reiterate, ‘removal of goods’ is a question of fact to be examined from the steps that would ensue once the supply is decided whereas ‘involves movement’ is a question of the state-of-affairs of the goods being supplied.

Therefore, it is important even before the arrival of time of supply, that the goods to be supplied be classified into one of these two cases, that is, whether it is a case of supply that involves movement or one that does not involve movement of the goods. Only when this classification of the goods has been clearly made does section 31 comes into operation.

Supply involves movement

Where the supply involves movement of goods then an invoice must be issued at the exact time when the goods are about to be removed. So, it is pertinent to identify the moment when the goods are considered to be getting removed. Section 2(96) defines removal in relation to goods as:

- a) Despatch of the goods for delivery by the supplier thereof or by any other person acting on behalf of such supplier
- b) Collection of the goods by the recipient thereof or by any other person acting on behalf of such recipient

As already explained above, movement of goods may be caused by the supplier (or his agent or transporter) or by the recipient (or his agent or transporter). When the movement is caused by the supplier, the point of removal will arise when the goods are despatched from the place of business of the supplier. The word ‘despatch’ means ‘to send off’. So, just before the goods are to be sent off, the invoice is required to be issued where the removal is by the supplier.

Illustration 3: Mr. X in Gujarat gets an order from Mr. Y in West Bengal on 18th March 2018 for supply of refrigerators. Mr. X dispatches the goods from his premises to his transporter’s premises on 20th March 2018. The transporter initiates the transportation on 22nd March 2018 and the goods finally reach the premises of Mr. Y on 26th March 2018. The removal of goods will be said to be caused on 20th March 2018 i.e. the date when the goods leave the premises of Mr. X. The last date of issue of invoice will also be 20th March 2018 in the given case.

Where the movement is by the recipient, the point of removal will arise when the goods are collected by the recipient from the premises of the supplier. This collection may be by the recipient or a person acting on his behalf as the agent or transporter or any other person. So, the invoice is to be issued by the supplier just before the point when the recipient (or his agent or transporter) collects the goods from his premises.

Illustration 4: Mr. X in Gujarat gets an order from Mr. Y in West Bengal on 18th March 2018 for supply of refrigerators. Mr. Y’s transporter takes delivery of the said goods from the premises

of Mr. X on 21st March, 2018 and delivers them to Mr. Y on 26th March 2018. As Mr. Y's transporter collected the goods for transportation on 21st March 2018, the date of removal will be considered as 21st March 2018 as well. The last date of issue of invoice will also be 21st March 2018 in the given case.

Illustration 5: Mr. X's manufacturing unit in Surat, Gujarat gets an order for supply of refrigerators from Mr. Y in West Bengal on 18th March 2018. It was agreed that Mr. Y's transporter will collect the goods from Mr. X's depot in Vadodara which is registered as an additional place of business under the same GSTIN as that of Surat. Mr. X removes the goods from his manufacturing unit to his depot on 20th March, 2018 which reaches the depot on 21st March 2018. Mr. Y's transporter collects these goods on 23rd March 2018 and the said goods reach Mr. Y on 28th March 2018. In this illustration, the movement of goods by the supplier between his premises cannot be called as a dispatch as it is not for delivery by the supplier. In fact, the first leg of the activity occurring between the units of Mr. X does not entail raising of invoice as it is not a supply. The removal of goods for supply to Mr. Y will arise only when the goods are collected by the transporter of Mr. Y from Vadodara i.e. 23rd March 2018 which will also be the last date of issue of invoice as per Section 31.

Supply does not involve movement

Where the supply involves movement of goods then an invoice must be issued at the exact time when the goods are about to be removed. And where the supply does not involve movement of goods then an invoice must be issued at whatever is the time when the goods are delivered or made available to the recipient. It is in this case – where supply does not involve movement – that the complexity remains even after making a proper classification. That is, determining the time when the goods are delivered or made available to the recipient. Delivery – the mode and the time – is the unilateral choice of the recipient and the supplier has no authority to decide 'how' and 'when' he will deliver the goods to the recipient. It only becomes easy in a contract for supply if it clearly records this 'choice' of the recipient regarding the mode and time of delivery. The supplier is always duty-bound to deliver in exactly the same way – manner and timing – which the recipient dictates. In fact, the supplier continues to be obligated until delivery is completed in the way it is stated by the recipient. In other words, delivery is not complete if there is any deviation in either the manner or the timing compared to that dictated by the recipient. When the delivery is to the satisfaction of the recipient, then the supplier is released from his obligation. Therefore, in all those cases (where supply does not involve movement) the additional question of fact to be determined is the mode and time of delivery dictated by the recipient and whether the same has been complied with, to the satisfaction of the recipient. It is now that section 31 comes into operation.

Illustration 6: Mr. X agrees to sell his godown in Gujarat to Mr. Y on 18th March 2018. There is a separate agreement entered by Mr. X and Mr. Y for the selling of refrigerators within the godown on 19th March 2018. Mr. X hands over the possession of the godown and the furniture on 25th March 2018. In this case, the furniture will be considered to be delivered to 25th March 2018 which will also be the last date of issue of invoice as per Section 31.

Continuous supply of goods

As per Section 2(32) of the CGST Act 2017, continuous supply of goods means a supply of goods which is provided or agreed to be provided continuously or on recurrent basis, under a contract whether or not by means of wire, cable, pipeline or other conduit and for which the supplier invoices the recipient on a regular or periodic basis and includes supply of such goods as the Government may subject to such conditions as it may by notification specify.

From the above definition, it may be inferred that there are two important conditions to be satisfied for a supply to be called as continuous supply of goods:

- a) The supply of goods should be provided on a continuous or recurrent basis
- b) The supplier should be invoicing the recipient on a regular or periodic basis

Once, these two conditions are satisfied, any supply will be considered as continuous supply of goods. For the purpose of continuous supply, it is necessary that successive statement of accounts or successive payments or both are involved for the purpose of determining the consideration for such supply. As per Section 31, in respect of continuous supply of goods, it has been stated that invoice should be issued before or at the time each such statement is issued or each such payment is received. Please note that regularity of supply does not always imply continuous supply. Maybe each supply is complete but there is a delay in billing. That cannot become continuous supply. There must be something contingent at the time of removal / movement that can only be determined after arrival or even consumption. Deliberate delay in invoice for regular supplies does not automatically result in continuous supply. If the billing cycle coincides with tax period, there may not be much consequence of regarding such transactions to be supply as tax does get paid timely. But, if the billing cycle is contractually longer than tax period, then care must be taken to correctly categorize as continuous supply.

Goods sent or taken on approval for sale or return basis

As per this system, certain goods are sent to the recipient without supplying/selling the same at its outset. These goods can be examined or tested by the recipient as to whether his requirements are fulfilled. The recipient can at his behest, approve the said supply or return the said goods. If the goods are returned, no supply will be deemed to have taken place. If the goods are approved by the recipient, then it will amount to a supply. The last date of issuance of invoice in such cases as per Section 31(7) of the CGST Act 2017 has been given as earlier of:

- a) Before or at the time of supply
- b) Six months from the date of removal

Here, time of supply refers to the time when the confirmation is given by the recipient that he is willing to accept the goods. The last date of issuance of invoice in such cases will be the confirmation of acceptance subject to the fact that this acceptance should not take place after six months from the date of removal. If the approval does not come within the time frame of six

months/comes after the period of six months from the date of removal, then the last date of invoice arises on the date when this period of six months from the date of removal expires.

In this regard, vide CBIC Circular No. 22/22/2017-GST, dated 21-12-2017, it has been clarified by CBIC that the movement of artwork from artist to art galleries shall not be constituted as supply as the same is sent on approval basis and the supply takes place when buyer selects a particular art work displayed at the gallery.

Also, vide CBIC Circular No. 10/10/2017-GST, dated 18-10-2017 it has been clarified that where goods are moved within the State or from the State of registration to another State for supply on approval basis i.e. such goods are to be considered as being carried on approval basis and a tax invoice can be issued when the buyer has approved the goods and taken the delivery.

Unlike the case of VAT law where an invoice is required to be issued when 'transfer of property' takes place and invoice does not have to be kept pending until they are physically removed, GST requires issuance of an invoice at the time of their 'removal' or 'delivery', as the case may be, notwithstanding any delay in transfer of property. As explained earlier, an invoice does not by itself prove anything except that it is a record of the terms of understanding of the underlying transaction. Accordingly, referring back to our brief mention about 'person and taxable person', the tests requiring examination under section 31 must be administered not only in a transaction between two persons but even on all the transactions between two taxable persons even if they belong to the same person.

It is only upon undertaking a detailed enquiry into the questions of fact determined under section 31 in the respective cases, will we be able to determine one of the two elements prescribed to be the 'time of supply' under section 12. Time of supply therefore, is earlier of date of invoice as per section 31 or date of receipt of payment with respect to the supply.

Exceptions:

- (i) When an amount is received in excess of tax invoice up to ₹1,000/-, the time of supply in respect of such excess at the option of the supplier shall be the date of such invoice.
- (ii) Supply shall be deemed to have been made to the extent of the value of supply indicated in the invoice or the value of payment received by the supplier.
- (iii) Date of receipt of payment shall be the date on which the payment is accounted in the books of the supplier or the date reflected in the bank account of the supplier, whichever is earlier.
- (iv) The registered person who did not opt for the composition levy under section 10 shall pay the central tax on the outward supply of goods at the time of supply as specified in section 12(2)(a) i.e. the date of issue of invoice by the supplier or the last date on which he is required, under section 31(1), to issue the invoice with respect to the supply. Therefore, no GST is payable on advances received against supply of goods. (NN-66/2017-Central Tax dated 15-Nov-17)). Earlier by Notification No.40/2017- Central Tax

dtd.13-Oct-17, the benefit was granted to only small assesses whose turnover in the preceding financial year or in the year in which he obtained registration does not exceed or is not likely to exceed ₹150 Lakhs. However subsequently the scope was enhanced to include all registered persons making supply of goods except the persons who have opted for composition under section 10. In summary, the taxability of the consideration received in advance would be as follows:

Period	Taxability of consideration received in advance	
	Aggregate turnover less than ₹ 1.5 crores	Aggregate turnover more than ₹ 1.5 crores
01.07.2017 to 12.10.2017	Taxable	Taxable
13.10.2017 to 15.11.2017	Not taxable	Taxable
15.11.2017 and onwards	Not taxable	Not taxable

The above notifications also refer to the situations attracting the provisions of Section 14 (change in rate of tax in respect of supply of goods or services). Accordingly, the date of receipt of advances would not be relevant for the purpose of ascertaining appropriate rate of tax in case of change. In other words, the applicable rate of tax in case of change in rate of tax would be ascertained based on the date of issuance of invoice and date of supply of goods only.

- (v) The provisions relating to job-work provides for supply of capital goods / inputs to the job-worker without payment of tax (section 143). The intention of the law is not to tax capital goods / inputs sent to job-worker as supply since in such an arrangement the goods are received back by the principal. However, if such goods are not received back within three years and one year respectively, it would qualify as supply by way of operation of deeming fiction provided under section 143(2) and section 143(3). In such a scenario, the date of sending the goods to the job-worker would be deemed to be the date when the goods were sent to the job-worker originally. It is important to understand here that the incidence of tax falls back on the date when the goods were sent to the and the operation of deeming fiction dictates the date of supply of goods as the time of supply. This would be in deviation to the general principles of ascertaining the time of supply viz., date of removal of goods on which the principal ought to have issued the invoice. In this regard, the Central Government has issued a Circular No. 38/12/2018 dated 26.03.2018 wherein it is clarified that the principal should issue an invoice on expiry of three years / one year and should declare such supplies in the return filed for the month in which the time period of three years / one year is expired.

Illustration 9: Assuming the circumstances given under the illustrations 3, 4, 5 and 6, please find the time of supply after considering the following additional information:

Actual date of issue of invoice	Date of receipt of payment	Amount received
21 st March 2018	19 th March 2018	5,00,000
	25 th March 2018	10,00,000

Answer: Since, the date of receipt of payment will be immaterial in considering the time of supply of goods, the earlier of the two dates i.e. the last date of issue of invoice and actual date of issue of invoice will be considered as the time of supply. So, the time of supply will be as follows:

Illustrations	Last date of issue of invoice	Actual date of issue of invoice	Time of Supply
Illustration 3	20 th March 2018	21 st March 2018	20 th March 2018
Illustration 4	21 st March 2018	21 st March 2018	21 st March 2018
Illustration 5	23 rd March 2018	21 st March 2018	21 st March 2018
Illustration 6	25 th March 2018	21 st March 2018	21 st March 2018

Illustration 10: A cement manufacturing company generates certain waste materials which are supplied to a recycling factory through a pipeline on a continuous basis.

- a) Situation 1: Monthly payments of ₹ 5,00,000 are to be made by 7th of the next month as per the contract. For the period October – December, following were the date of issuance of invoices and payments:

Period	Date of issuance of invoice	Date of receipt of payment
October	4 th November 2018	6 th November 2018
November	6 th December 2018	8 th December 2018
December	9 th January 2019	5 th January 2019

- b) Situation 2: Monthly statement of accounts are to be prepared by 5th of the next month as per the contract. For the period October, following were the dates of issuance of the successive statement of account and the date of issuance of invoices:

Period	Date of issuance of invoice	Date of issuance of the statement of account
October	4 th November 2018	6 th November 2018
November	6 th December 2018	3 rd December 2018
December	9 th January 2019	5 th January 2019

Answer:

Situation 1: Where there are successive payments involved, the last date of issuance of invoice is the date of receipt of such payment. As per Section 12(2), the time of supply should be the earlier of the date of issuance of invoice or the last date of issuance of the invoice. It may be noted that as per Notification no. 66/2017-CT dated 15th November 2017, only these two events are to be considered and the date of receipt of payment as mentioned under Section 12(2)(b) may be ignored. The due date when the payment should be received is also immaterial as it has not been specified in either the time of supply provisions or the provisions of the last date of issuance of invoice. Thereby, the time of supply in the given case will be the earlier of the date of receipt of successive payment (last date of issuance of invoice) of the actual date of issuance of invoice.

Period	Date of issuance of invoice	Date of receipt of payment	Time of supply
October	4 th November 2018	6 th November 2018	4 th November 2018
November	6 th December 2018	8 th December 2018	6 th December 2018
December	9 th January 2019	5 th January 2019	5 th January 2019

Situation 2: Where there are successive statements of accounts that are to be prepared, the last date of issuance of invoice will be the date of issuance of such successive statement. As per Section 12(2), the time of supply should be the earlier of the date of issuance of invoice or the last date of issuance of the invoice. It may be noted that as per Notification no. 66/2017-CT dated 15th November 2017, only these two events are to be considered and the date of receipt of payment as mentioned under Section 12(2)(b) may be ignored. The due date when the successive statement should be prepared is immaterial as it has not been specified in either the time of supply provisions or the provisions of the last date of issuance of invoice. Only the actual date of the preparation of the statement needs to be considered. Thereby, the time of supply will be the earlier of the date of issuance of successive statement of account (last date of issuance of invoice) and the date of invoice.

Period	Date of issuance of invoice	Date of issuance of the statement of account	Time of supply
October	4 th November 2018	6 th November 2018	4 th November 2018
November	6 th December 2018	3 rd December 2018	6 th December 2018
December	9 th January 2019	5 th January 2019	5 th January 2019

Illustration 11: Certain goods are sent by Mr. X on sale on approval or return basis to Mr. Y on 22nd April 2018. The supply gets confirmed and invoice is issued on:

Case 1: 20th August 2018

Case 2: 23rd October 2018.

Payment in each of the cases is made on 23rd November 2018.

Answer: Date of receipt of payment is immaterial for the purpose of calculating time of supply u/s 12(2) of the CGST Act 2017. So, 23rd November 2018 should be ignored altogether. The time of supply should be earlier of the date of issuance of invoice or the last date of issuance of invoice. The last date of issuance of invoice will be the earlier of the confirmation of supply or six months from the date of removal.

In case 1, the confirmation of supply occurred before 6 months from the date of removal. So, the last date of issuance of invoice was 20th August 2018. On this date, the invoice was issued. So, the time of supply will be 20th August 2018.

In case 2, the confirmation of supply happened after 6 months from the date of removal. Six months expired on 21st September 2018. So, the invoice was required to be issued by this date. Since the invoice was issued on 23rd October 2018, the actual date of issue of invoice will be considered as falling after the last date of issuance of invoice. So, the time of supply will be the last date of issuance of invoice i.e 21st September 2018.

(c) Time of Supply – Reverse Charge.

Where tax is payable on reverse charge basis, the time of supply is appointed to be the earliest of (a) date of receipt of goods, (b) date of payment or (c) 30 days from the date of issue of invoice by the supplier. If for any reason, one of these three dates cannot be determined then the time of supply will be the date of recording the supply in the books of the recipient.

Keeping in mind the definition of reverse charge in section 2(98), the above provision does not apply to payment of tax by an electronic commerce operator but only to those cases of supply which fall under sub-section 5 of section 9 of the Act.

Exception:

Date of receipt of payment shall be the date on which the payment is accounted in the books of the supplier or the date reflected in the bank account of the supplier, whichever is earlier.

Reverse charge in case of goods may arise either under Section 9(3) or Section 9(4) of the CGST Act. Section 9(3) empowers the issuance of notification by the Government under which the tax will be paid by the recipient of goods as per reverse charge mechanism. Notification no. 4/2017-Central Tax (Rate) dated 28.06.2017 as amended from time to time provides the list of goods which will be subject to reverse charge mechanism subject to the category of supplier and recipient specified therein. These goods include cashew nuts (not shelled or peeled), bidi wrapper leaves (tendu), tobacco leaves, raw cotton, silk yarn, supply of lottery etc.

Prior to enactment of Amendment Act, section 9(4) required the recipient of taxable goods/services to pay tax if it is registered and receives inward supplies from unregistered suppliers. The applicability of which was deferred from 13th October 2017 till 30th September 2019. However, it was applicable for intra state supplies subject to the aggregate amount of such supplies exceeding ₹ 5000 in a day and all interstate supplies without any limit till 12th October 2017.

It is pertinent to mention that in view of bringing into effect the amendments (regarding RCM on supplies by unregistered persons) in the GST Acts vide Notification No 01/2019-Central Tax (Rate), dt. 29-01-2019, reverse charge exemption notification has been rescinded

Illustration 12: Mr.X, an agriculturist supplies raw cotton (under reverse charge) to Mr. Y who manufactures cotton shirts. The date wise turnout of events are given below:

01.04.2018- Mr.Y approaches Mr.X and places an order for 2 tonnes of cotton

10.04.2018- Mr.Y receives the goods

15.04.2018- Mr.X issues an invoice

20.04.2018- Mr.Y makes a payment by cheque and accordingly records it in his books of accounts.

25.04.2018- The payment gets debited from Mr.Y' s bank account

What will be the time of supply in the given case?

Answer: The time of supply shall be the earlier of the following dates:

- a. the date of receipt of goods i.e. 10.04.2018
- b. the date of payment as recorded in the books of Mr.Y i.e. 20.04.2018 or the date when the payment gets debited in the books of the recipient i.e. 25.04.2018 whichever is earlier
- c. the date immediately following thirty days from the date of issue of invoice, i.e. $15.04.2018 + 30\text{days} + 1\text{day} = 16.05.2018$

Therefore, the time of supply will be 10.04.2018.

(d) Time of Supply – Vouchers

The Act introduces time of supply in respect of 'vouchers' as a separate category such that the provisions relating to time of supply of goods is made inapplicable when the supply is of such vouchers. Referring to Chapter III where in the context of supply, definition of goods has been discussed at length, we find specific inclusion of 'actionable claims'.

In relation to actionable claims, Courts have held as follows:

- (i) Actionable claims come within the definition of goods as generally understood.
- (ii) VAT laws have deliberately excluded actionable claims from the definition of goods.
- (iii) Actionable claims represent debt and accordingly carry a demand that can lawfully be made by one person against another.

(iv) Actionable claims represent property in non-physical (incorporeal) form.

But in GST, unlike VAT laws, we find that by including actionable claims within the definition of goods, they are made liable to tax. In relation to actionable claims under GST, please note the following key aspects:

- (i) Actionable claims are included specifically in the definition of goods, but this inclusion is by creating an exception from an exclusion. In other words, while excluding money and securities from the definition of goods, actionable claims have been singled out. This means such forms of actionable claims that represent property in the form of money or securities are also excluded from the definition of goods. Therefore, from a large population of actionable claims, tax is applicable only on the subset of actionable claims which do not represent property in the form of money or securities and all other forms of actionable claims representing any other property is includable in the definition of goods. A receipt for having made payment is not actionable claim because that receipt represents money and not the result of a transaction resulting in debt or demand. Similarly, promissory notes, IOU slips and all other derivatives of such instruments are also not actionable claims for the purposes of GST because of the exclusion of money from the definition.
- (ii) Actionable claims which are included within the definition of goods do not become includable in the definition of services due to the accommodative and expansive language used to define services. For this reason, the property that actionable claims represent even if they are in non-physical form will continue to remain goods and not become services. Actionable claims so understood may or may not be itself in any physical form. In other words, actionable claim is not the piece of paper carrying the detailed description of the actionable claim in question but the real property, though in non-physical form, that is referred to in that piece of paper. In this digital age, piece of paper carrying the description of the actionable claim can even be present in electronic form and still retain the character of actionable claim within the definition of goods. So, actionable claims can be in physical or electronic form as long as they represent real property.

About 'actionable claims' discussion in Chapter III would have highlighted that the incidence is limited to 'lottery, betting and gambling'. Further, it is important to note that vouchers are not always referring only to actionable claims. Vouchers being treated as a separate category for the purposes of determining time of supply will need to be first identified in relation to supply before applying the relevant provision regarding its time of supply. Vouchers are defined in the Act as "an instrument where there is an obligation to accept it as consideration or part consideration for a supply of goods or services or both and where the goods or services or both to be supplied or the identities of their potential suppliers are either indicated on the instrument itself or in related documentation, including the terms and conditions of use of such instrument" and examples of voucher are coupon, token, ticket, license, permit, pass.

Now, the time of supply in the case of vouchers is stated to be:

- (i) the date of issue of voucher if the supply is identifiable at that point; or

(ii) in all other instances, the date of redemption of the voucher.

Please refer to the section 13 regarding time of supply of services for detailed discussion on the overall aspect of vouchers.

Here, only the key aspects of the definition are discussed which may be referred back while examining the scope of section 13(4).

Money 2(75) may be represented as follows:

Object		Purpose
Indian legal tender *	Foreign currency **	Used as consideration to:
Cheque, promissory note, bill of exchange, letter of credit, draft, pay order, traveller cheque, money order, postal or electronic remittance or any other instrument recognized by RBI #		<ul style="list-style-type: none"> ➤ settle an obligation or ➤ exchange with Indian legal tender of different denomination (not held for numismatic value)
* currency recognized by law – RBI Act, 1934 and includes currency notes and coins. Legal tender issued records liability of the Central Government and a guarantee to its holder to secure value-in-exchange		
** legal tender of other countries recognized by India. Does not include securities denominated in foreign currency		
# stored value instrument known as Pre-Paid Instrument (PPI) issued by a licensee under Payment and Settlement Systems Act, 2007		

Money is therefore that which is 'used as' consideration between parties to a transaction. Money does not represent a liability of the parties to the transaction. Money represents liability of the Central Government. A person who has money has an asset which represents a certain amount of value. There is requirement to specially prescribe 'terms of use' of money. It is known and is declared by the law that recognizes money to be legal tender. Money includes all 'stored value' instruments approved by RBI or PPIs. Value is stored in PPIs by transfer of Indian legal tender in cash or from bank account and any balance of stored value in PPIs can be withdrawn in ATM or retransferred back into bank account. PPIs are of three types – closed, semi-closed and open PPIs. There are two other kinds of hybrids where existing banking license-holders along with a technology partner can issue PPI-like stored-value products which operate as a specie of savings bank account of the PPI-holder or beneficiary. PPIs can be physical bearer instruments as paper certificate or plastic card. PPIs can also be non-physical in the form of a digital wallet. Both represent stored value which is linked to a bank account of the beneficiary. PPIs are not to be misunderstood with Payments Bank. PPIs have more restrictions than a Payments Bank which is a scaled-down version of a regular savings bank account.

Voucher 2(119) may be represented as follows:

Object	Description
Instrument with obligation	Created by contract between private Parties
Value represented	As per terms of use
Stored value	Nil; only value of obligation admitted
Obligor (person liable to discharge admitted obligation)	Issuer or other name obligor
Parties involved	3 or more parties – supplier, receiver and obligor

Voucher is therefore 'instrument with obligation' that is accepted as consideration. Voucher does not contain any 'stored value' but 'value-to-use'. This 'value-to-use' is credited into a voucher by a contractual arrangement between the issuer-redeemer of the voucher. A customer who redeems the voucher is not a party to the arrangement for creation of the voucher. A voucher that is created changes hands through steps with a sliding-scale of discounts until it is redeemed at the face value. This 'value-to-use' at the time of its creating necessarily involves flow of payment from the issuer to the redeemer as such voucher represent cash/cash equivalent received in advance entailing an obligation. But this value-to-use, cannot be converted to cash but only expended or redeemed as per terms of use of voucher. There is no regulation governing issue, transfer and redemption of vouchers except terms of a lawful contract. Vouchers are not PPIs and hence not governed by Payments and Settlement Systems Act, 2007. It is not uncommon for the available balance of 'value-to-use' to be credited into the digital wallet of a PPIs issued by the same issuer. But the difference is that the part of the wallet balance representing stored value can be withdrawn but not the part of the wallet balance representing value-to-use or voucher. Gift voucher issued by a merchant that is a bearer certificate with a unique identification number or code is not a voucher that agrees with this definition because this gift voucher is a close-ended PPI.

Another similar product is 'loyalty points' which also contains 'value-to-use' but the difference is that in loyalty points, issuer-redeemer is the same person. Loyalty points issued represents liability of the issuer towards the beneficiary without any underlying flow of payment and is best described as 'future discount'. That is, these points accrue in one transaction and based on some conversion ratio, that can be redeemed as a discount in a subsequent transaction. As the loyalty points are non-transferable where the issuer-redeemer is the same person, it is not an instrument with obligation. Discount allowed in the subsequent transaction is towards cancellation of points accrued from the earlier transaction. Similar to vouchers, loyalty points also do not have any regulation governing its allotment and redemption except the terms of a lawful contract. Nowadays, it is seen that the liability that accumulated loyalty points represents, are being converted into voucher by transfer of liability by issuer to an intermediary at a discounted value. From here onwards, due to intermediary's involvement, an instrument comes into existence with an obligation which is voucher.

Yet another product coupon or token in the form of a 'code', where a customer becomes entitled to discount at the very first purchase by citing this 'code'. It is interesting to note that entitlement to this code though not flowing from a transaction in the past, it is an entitlement by accepting to enter into a transaction in the future. This acceptance is recorded by registering on a website, downloading an app or any other positive act on the part of the customer. Such codes also do not satisfy the requirements of a voucher for the same reasons as applicable to loyalty points.

Among all these lies another transaction that may appear to overlap with definition of voucher, due to the words of common understanding being used interchangeably with words having specific statutory meaning and that is 'Pass'. Pass is one which could be an entry pass or customer's pass or a free ticket. For example, a ticket to a cricket match is available for ₹1,000/- but a company buys these tickets and distributes it to key customers as 'free pass'. It allows the customer to enjoy the cricket match without paying anything for the same. But the company has already paid the ticket price to the organizers of the cricket match. Another example could be free pass to view screening of a film and so on. There is a normal taxable supply between the supplier of goods or services and the person who pays and buys the 'pass'. There is another supply to be examined, between the person who pays and the person who actually enjoys the goods or services. Whatever may the conclusions reached regarding the two transaction here, there is no voucher that comes into existence even if such entry tickets are even designated as 'free pass – not for sale' and so on. However, if such 'passes' are printed and distributed out of the ordinary course of ticket sales without reference to a specific event but permitting access to a basket of events and valid for a duration of time, then it partakes the character of voucher – instrument with obligation. When the 'Pass' loses its character as an 'advance paid' for a supply in future – whether to the Payer or any other bearer – and becomes an 'instrument with obligation', then the 'Pass' becomes a voucher.

Criteria	Money	Voucher	Loyalty Points
Instrument type	Indian legal tender, foreign currency or stored value PPI of cash paid	Physical card / non-physical account of cash received	Points-statement of accrued discount from past transactions
Beneficiary	Bearer of cash or account-holder of PPI	Bearer or account-holder	Account-holder
Represents cash deposited	Yes, paid by Beneficiary *	Yes, paid by third party Issuer *	No, notional credit of loyalty points
Paid value = Face value on redemption	Yes, no discount and no premium	No, discounted value is paid by redemption of face value	NA

Paid value refundable	Yes, stored-value	No, only value-to-use	NA, discount-to-claim
Transferrable	No	Yes	Yes **
Issuer is redeemer	Yes	No	Yes
Redemption by	Bearer	Bearer	Account-holder
Unredeemed value	Continues	Loss to issuer	Lapse
Governing law	PSS Act	Contract Act	Contract Act

* includes nominee of bearer-instruments

** becomes voucher on transfer of accumulated points before redemption

Illustrations:

Illustration	Voucher or Not	Nature of Instrument
Shopping gift card purchased for ₹5,000/-	Not voucher	It's money, by way of 'stored value' even if not encashable
Coupons or token given to customer by pizza outlet on making purchase of ₹1,000/- which allows 10% discount on next purchase	Not voucher	It is future discount by way of 'value-to-use' not encashable
Money deposited into digital wallet	Not voucher	It's money, by way of 'stored value' though encashable
Points credited into digital wallet	Not voucher	It is future discount by way of 'value-to-use' not encashable
Transfer of liability towards accumulated loyalty points credited to customers	Voucher	Now it's become an 'instrument with obligation'
Pre-paid instruments: ➤ Telephone calling card / recharge card ➤ Multi-currency traveller's card ➤ DTH recharge card	Not voucher	It's money received in advance to be settled by making supplies in future
Non-instrument based advances: ➤ Receipt issued to customer for acknowledging advance payment received towards PO issued	Not voucher	It's money received in advance to be settled by making supplies in future

<ul style="list-style-type: none"> ➤ Advance booking of film ticket ➤ Train ticket purchased in advance ➤ Contribution of instalments into 'gold savings scheme' ➤ Time-share in resort 		
---	--	--

The reason why it is important to differentiate whether it is a voucher or not, is that if the instrument is money then tax is payable on the actual 'paid-in value' and not the 'value-to-use' (or redeemable face value). For example, customer pays advance of ₹1,00,000 to distributor and the distributor transfers ₹80,000 to manufacture. GST payable by the distributor will be on ₹1,00,000 and the GST payable by the manufacturer will be on ₹80,000. Ignoring the fact that credit is not allowable, this would be the treatment in respect of any instrument that fits the definition of money. However, if a voucher was supplied by the manufacturer to the distributor of face value (or value-to-use) ₹1,00,000 but paid-in value ₹80,000, GST would be payable by the manufacturer on ₹1,00,000 and not ₹80,000. Further, anomalies arise on account of distributors liability to pay GST on ₹1,00,000 but with serious concerns on availability of credit of tax charged by manufacturer. Without satisfying conditions under section 16(2) read with rule 28, credit would not be available and tax would be collected on face value or value-to-use and not the actual paid-in value. Payment of tax in the case of vouchers on face value or value-to-use is found in rule 32(6).

It is important to understand that a similar provision as specified in relation to time of supply of goods also exists in time of supply of services. It is reasonable to, therefore, infer that the Government in its wisdom, in all probability, will treat 'vouchers relating to goods' and 'vouchers relating to services' as distinct and separate class of transactions. What does one understand by 'vouchers relating to goods' and 'vouchers relating to services'? A layman would comprehend that vouchers relating to goods would be those class of transactions which can be exchanged for goods whereas vouchers relating to services being distinct and separate can be exchanged only for services. There can be a third class of transactions relating to vouchers, namely, a gift voucher issued by a bank which can be exchanged only for cash. But a plain reading of definition of goods and services indicates that they both exclude money. Therefore, such vouchers relating to cash / money can be safely assumed to be outside the ambit of GST laws.

It is possible for one to construe that a voucher relating to goods can be embedded for the provision of services also. Such class of transactions must be read with Schedule II to understand whether they are to be treated as goods or as services and thereafter apply the principles laid down to the transaction as if they were goods or services. And in such situations, await until time of redemption to determine the rate of tax and class of supply.

Interesting situations arise in respect of such transactions. For instance, the points accumulated in a credit card could be used to exchange for goods or issue of an air ticket.

Difficulty arises in taxing such transactions in the hands of the person issuing such points. However, the taxability or otherwise of such accumulated points would need detailed deliberations based on facts and surrounding circumstances of each case.

As discussed above, the time of supply of goods in case of supply of vouchers by a supplier will be:

- a) date of issue of voucher if the supply is identifiable at that point
- b) date of redemption of voucher in all other cases

This basically means that if the exact nature of goods to be supplied along with its quantity value of such goods are available when the voucher is issued, the time of supply will be the date of issue of voucher. On the other hand, if the nature of supply of goods are not available at the time of issue of voucher, then the time of supply will be considered as the date of redemption of voucher. This is not to say that the time of supply will determine the value also. This is because as per Rule 32(6), the value will always be the redemption or face value of the voucher irrespective of the time of supply.

(e) Time of Supply – Residuary

Where none of the above provisions are able to satisfactorily answer the time of supply, it is to be determined based on the residuary provision which states that the time of supply is:

- (i) where a periodical return has to be filed, the due date prescribed for such return; or
- (ii) in any other case, the date of payment of the tax.

Time of supply under this residuary provision is applicable only when the other provisions are found to be inapplicable and not merely when there is some difficulty in determining the facts that are sought for by the relevant provision.

(f) Time of Supply – Special Charges

Special charges imposed for delay in payment of consideration will enjoy the facility of time of supply being date of receipt of the charges imposed, that is, cash-basis of payment of GST. The various issues involved in these special charges are discussed in detail under time of supply of services which may kindly be referred.

Illustration 13: Mr. X enters into a contract for supply of goods worth ₹ 5,00,000 with Mr. Y on 10th April 2018. Such goods are removed with an invoice dated 12th April 2018 on 13th April 2018 for delivery to Mr. Y. The terms of the contract demanded the payment against such supply to be made within 60 days beyond which a late payment charge of ₹ 10,000 will have to be paid by Mr. Y. Mr. Y makes the payment of Rs, 5,00,000 along with the late payment charges on 15th July 2018. What will be the time of supply in respect of the entire amount?

Answer: In Section 12(2), the time of supply in respect of ₹ 5,00,000 will be the date of issuance of invoice or last date of issuance of invoice. Last date of issuance of invoice will be the date of removal where supply involves movement of goods.

Date of issuance of invoice: 12th April 2018

Last date of issuance of invoice: 13th April 2018 (date of removal)

The date of payment is immaterial as per Notification no. 66/2017-Central Tax dated 15th November 2017 as already discussed above. So, the time of supply will be 12th April, 2018 in respect of ₹ 5,00,000.

However, in respect of the time of supply for the amount of Rs, 10,000 paid as late payment charges, time of supply as per Section 12(6) has been stated to be the date on which the supplier receives the addition in value. Here, the additional amount of ₹ 10,000 is received on 15th July 2018. So, the time of supply for this amount will also arise on 15th July 2018..

Some illustrations for better understanding of the provisions of time of supply of goods

	Concept illustrations Section 12(2)	Invoice date	Invoice due date	Payment entry in supplier's books	Credit in bank account	Time of supply
1	Invoice raised before removal	10-Oct-17	20-Oct-17	26-Oct-17	30-Oct-17	10-Oct-17
2	Advance received (See Note 1)	30-Oct-17	20-Oct-17	10-Oct-17	30-Oct-17	10-Oct-17
3	Advance received	30-Nov-17	20-Nov-17	16-Nov-17	30-Nov-17	20-Nov-17

Notes:

1. The Notification 40/2017 dated 13.10.2017 exempts a taxable person not registered under the composition scheme and having aggregate turnover less than ₹ 1.50 crores, for payment of tax on receipt of advance. This Notification will be effective from 13.10.2017 and as such a taxable person is liable to remit tax on any advances received prior to 13.10.2017.
2. The Notification No. 66/2017 dated 15.11.2017 exempts all taxable persons from payment of tax on the advances received in relation to supply of goods. This Notification will be effective from 15.11.2017 and as such, the date of receipt of advance will not be relevant to determine the time of supply of goods thereafter.

	Supply involves movement of goods Section 12(2) r/w Section 31(1)(a)	Invoice/ document date	Removal of goods	Delivery of goods	Receipt of payment	Time of supply
4	Delayed issue of invoice	26-Oct-17	20-Oct-17	26-Oct-17	26-Oct-17	20-Oct-17
5	Inter-State stock transfer	10-Oct-17	20-Oct-17	26-Oct-17	10-Nov-17	10-Oct-17

6	Advance received, invoice for full amount issued on same day (40% advance, 60% post supply payment)	30-Oct-17	10-Nov-17	14-Nov-17	30-Oct-17	30-Oct-17
					20-Nov-17	30-Oct-17

	Supply otherwise than by involving movement of goods Section 12(2) r/w Section 31(1)(b)	Invoice date	Receipt of invoice by recipient	Delivery of goods	Receipt of payment	Time of supply
7	Delayed issue of invoice	30-Oct-17	05-Nov-17	26-Oct-17	10-Nov-17	26-Oct-17
8	Invoice issued prior to delivery	20-Oct-17	10-Nov-17	26-Oct-17	10-Nov-17	20-Oct-17

	Continuous supply of goods Section 12(2) r/w Section 31(4)	Invoice date	Removal of goods	Due date of payment as per agreement	Receipt of payment	Time of supply
9	Contract provides for successive statements of account/successive payments	01-Nov-17	15-Oct-17	05-Nov-17	01-Nov-17	01-Nov-17
10			25-Oct-17			
11		08-Jan-18	08-Nov-17	05-Dec-17	11-Dec-17	05-Dec-17
			30-Nov-17			
			14-Dec-17	05-Jan-18	01-Jan-18	01-Jan-18
		23-Dec-17				

	Reverse charge Section 12(3)	Date of invoice issued by supplier	Removal of goods	Receipt of goods	Payment by recipient	Time of supply
12	General	31-Oct-17	31-Oct-17	20-Nov-17	30-Nov-17	20-Nov-17
13	Advance paid	31-Oct-17	31-Oct-17	20-Nov-17	05-Nov-17	05-Nov-17
14	No payment made for the supply	31-Oct-17	30-Dec-17	05-Jan-18	-	30-Nov-17

	Sale on approval basis Section 12(2) r/w Section 31(7)	Removal of goods	Issue of invoice	Accepted by recipient	Receipt of payment	Time of supply
15	Acceptance communicated within 6 months of removal	01-Nov-17	25-Nov-17	15-Nov-17	25-Nov-17	15-Nov-17
16	Amount paid to supplier before informing acceptance	01-Nov-17	25-Nov-17	15-Nov-17	12-Nov-17	15-Nov-17
16	Acceptance not communicated within 6 months of removal	01-Oct-17	15-May-18	15-May-18	02-May-18	01-Apr-18

Statutory Provisions

<p>13. Time of supply of services</p> <p>(1) The liability to pay tax on services shall arise at the time of supply, as determined in accordance with the provisions of this section.</p> <p>(2) The time of supply of services shall be the earliest of the following dates, namely:—</p> <p>(a) the date of issue of invoice by the supplier, if the invoice is issued within the period prescribed under sub-section (2)² of section 31 or the date of receipt of payment, whichever is earlier; or</p> <p>(b) the date of provision of service, if the invoice is not issued within the period prescribed under sub-section (2)³ of section 31 or the date of receipt of payment, whichever is earlier; or</p> <p>(c) the date on which the recipient shows the receipt of services in his books of account, in a case where the provisions of clause (a) or clause (b) do not apply:</p> <p>Provided that where the supplier of taxable service receives an amount up to one thousand rupees in excess of the amount indicated in the tax invoice, the time of supply to the extent of such excess amount shall, at the option of the said supplier, be the date of issue of invoice relating to such excess amount.</p>
--

² Omitted vide The Central Goods and Services Tax Amendment Act, 2018 w.e.f. 01.02.2019

³ Omitted vide The Central Goods and Services Tax Amendment Act, 2018 w.e.f. 01.02.2019

Explanation. —For the purposes of clauses (a) and (b)—

- (i) the supply shall be deemed to have been made to the extent it is covered by the invoice or, as the case may be, the payment;
 - (ii) “the date of receipt of payment” shall be the date on which the payment is entered in the books of account of the supplier or the date on which the payment is credited to his bank account, whichever is earlier.
- (3) In case of supplies in respect of which tax is paid or liable to be paid on reverse charge basis, the time of supply shall be the earlier of the following dates, namely:—
- (a) the date of payment as entered in the books of account of the recipient or the date on which the payment is debited in his bank account, whichever is earlier; or
 - (b) the date immediately following sixty days from the date of issue of invoice or any other document, by whatever name called, in lieu thereof by the supplier:
- Provided that where it is not possible to determine the time of supply under clause (a) or clause (b), the time of supply shall be the date of entry in the books of account of the recipient of supply:
- Provided further that in case of supply by associated enterprises, where the supplier of service is located outside India, the time of supply shall be the date of entry in the books of account of the recipient of supply or the date of payment, whichever is earlier.
- (4) In case of supply of vouchers by a supplier, the time of supply shall be—
- (a) the date of issue of voucher, if the supply is identifiable at that point; or
 - (b) the date of redemption of voucher, in all other cases.
- (5) Where it is not possible to determine the time of supply under the provisions of sub-section (2) or sub-section (3) or sub-section (4), the time of supply shall—
- (a) in a case where a periodical return has to be filed, be the date on which such return is to be filed; or
 - (b) in any other case, be the date on which the tax is paid.
- (6) The time of supply to the extent it relates to an addition in the value of supply by way of interest, late fee or penalty for delayed payment of any consideration shall be the date on which the supplier receives such addition in value.

Relevant circulars, notifications, clarifications issued by Government:

1. Notification No. 9/2017 – Central Tax dated 28.06.2017 Seeks to appoint 01.07.2017 as the date on which the provisions of Section 12 are effective.
2. Notification No. 13/2017 dated 28.06.2017 Categories of services on which CGST is payable under reverse charge mechanism.

3. Notification No. 66/2017 – Central Tax dated 15.11.2017 Seeks to exempt all taxpayers from payment of tax on advances received in case of supply of goods (*This notification is issued superseding the earlier Notification No. 40/2017 – Central Tax dated 13.10.2017 wherein the exemption from payment of tax on receipt of advances was extended to a registered person whose aggregate turnover is less than ₹ 1.5 crores*);
4. Notification No. 10/2017 – IGST (Rate) dated 28.06.2017 Categories of services on which IGST is payable under reverse charge mechanism
5. Notification No. 4/2018 - Central Tax (Rate) dated 25.01.2018 providing special procedure with respect to payment of tax by registered person supplying service by way of construction against transfer of development right and vice versa.
6. Circular No. 38/12/2018 dated 26.03.2018 is issued clarifying the levy of GST, time of supply of goods and value of supply in case of goods sent for job-work.
7. Circular No. 38/12/2018 dated 26.03.2018 is issued clarifying the levy of GST, time of supply of goods and value of supply in case of goods sent for job-work.

Related provisions of the Statute:

Section or Rule (CGST / SGST)	Description
Section 2(12)	Definition of Associated Enterprises
Section 2(31)	Definition of Consideration
Section 2(41)	Definition of Document
Section 2(56)	Definition of India
Section 2(66)	Definition of Tax Invoice or Invoice
Section 2(87)	Definition of Prescribed
Section 2(93)	Definition of Recipient
Section 2(97)	Definition of Return
Section 2(98)	Definition of Reverse Charge
Section 2(102)	Definition of Services
Section 2(105)	Definition of Supplier
Section 2(118)	Definition of voucher
Section 7	Scope of Supply
Section 9	Levy and Collection
Section 14	Change in rate of tax in respect of supply of goods or services
Section 15	Value of taxable supply

Section 31	Tax invoice, credit note and debit note
Section 39	Furnishing of Returns

13.1 Analysis

(a) Time of Supply – Forward Charge

Similar to goods, time of supply of services is prescribed to be the earlier of date of issue of invoice and date of receipt of payment. Date of issue of invoice requires us to examine section 31 which deals with the requirement to issue a “tax invoice”. In relation to services, section 31 requires that a tax invoice be issued whether before or after provision of service. Further, there is a time limit beyond which tax invoice to be issued in arrears cannot be delayed after completion of the provision of service.

Rule 47 of the CGST Rules prescribes the time period within which such invoice should be issued. It states that in case of the taxable supply of services, invoice should be issued within thirty days from the date of supply of services. In case of banking company/financial institution/non-banking financial company, the time period becomes forty five days from the date of supply of services. When these banking/financial institution/non-banking financial institution/telecom operator companies make taxable supplies of services between distinct persons invoice may be issued before or at the time such supplier records the same in his books of account or before expiry of the quarter during which the supply was made.

If the invoice is issued within the prescribed time period, the time of supply will be the earlier of the date of issue of invoice or the date of payment. If the invoice is issued after the prescribed time period, the time of supply will be the earlier of the date of completion of service or the date of payment. If none of these two cases are applicable, then the time of supply will be the date when the recipient shows the receipt of services in his books of accounts.

Please recollect the discussion in Chapter III where it has been explained that in accordance with Schedule II, supplies involving goods may be treated as supply of services. In all such cases, as in the case of services ordinarily understood, this provision alone applies for determination of time of supply. One may also refer to Chapter VII regarding issuance of tax invoice in all other circumstances and determine from there the fact of issuance of tax invoice.

Therefore, where the tax invoice has been issued accordingly, the time of supply can be determined to be earlier of date of issuance of such tax invoice or date of receipt of payment.

Illustration 1: Mr. X provides consultancy services to Mr. Y worth ₹ 50,000.

08.04.2018 – An advance of ₹ 10,000 is received from Mr. Y

10.04.2018 – The consultancy services are provided

16.05.2018 – Mr X receives balance payment of ₹ 40,000 and records it in his books.

What will be the time of supply assuming Mr. X issues the invoice on:

Situation 1 - 15.04.2018

Situation 2 – 15.05.2018

Answer:

Situation 1: If invoice is issued within the prescribed time period, time of supply will be the date of receipt of payment or date of issue of invoice whichever is earlier. In the given case, the invoice is issued on 15.04.2018 which is within 30 days of the supply of services which is within the prescribed period. So, for ₹ 10,000, the time of supply will be 08.04.2018 which is the date of receipt of advance payment. For the balance amount, time of supply will be 15.04.2018 which is earlier of 15.04.2018 (date of invoice) and 16.05.2018 (date of receipt of payment).

Situation 2: If invoice is not issued within the prescribed time period, time of supply will be the earlier of the date of completion of service and the date of receipt of payment. Here, invoice is issued on 15.05.2018 which is after the prescribed time period. So, for ₹ 10,000, the time of supply will be 08.04.2018 which is the date of receipt of advance payment. For the balance amount, time of supply will be 10.04.2018 which is earlier of 10.04.2018 (date of completion of service) and 16.05.2018 (date of receipt of payment).

Illustration 2: During investigation, it was found that Mr. X had provided catering services of ₹ 1,00,000 to Mr. Y during his business convention. The payment for these services was made in cash. Mr. X had neither issued any invoice nor recognised the payment in his books of accounts. Mr. Y recorded the payment of ₹ 1,00,000 in cash in his books on 28th April 2018. What will be the time of supply in this case?

Answer: Since, the date of receipt of payment or the date of invoice is not available in case of Mr. X, the date when the payment is recorded in the books of the recipient becomes relevant. Since, Mr. Y recorded this on 28th April, the time of supply for such supply will also be considered as 28th April 2018.

Exceptions:

- (i) When an amount in excess of tax invoice is received up to ₹ 1,000/-, the time of supply in respect of such excess at the option of the supplier shall be the date of such invoice.

Illustration 3: A telephone company receives ₹ 4,000 on 27th July 2018 against an invoice of ₹ 3,700 on 23rd July 2018 in respect of the services provided. The excess amount of ₹ 300 can be adjusted against the invoice to be issued in the next month. Time of supply will arise only for ₹ 3700 on 23rd July 2018. For the balance amount of ₹ 300, the time of supply may not arise on 27th July 2018 at the option of the supplier and may be adjusted against the next month's invoice.

- (ii) Supply shall be deemed to have been made to the extent the value of supply indicated in the invoice or the value of payment received by the supplier.

Illustration 4: In Illustration 3, assume that the payment received was ₹ 5000 instead of ₹ 4000. Since, the amount exceeds ₹ 1000 in terms of the excess payment received, there is no option with the supplier. Here, the supply will be deemed to have been made to the extent of the invoice of ₹ 3700 on 23rd July 2018 and the balance amount of ₹ 1300 will be liable to tax on 27th July 2018.

- (iii) Date of receipt of payment shall be the date on which the payment is accounted in the books of the supplier or the date reflected in the bank account of the supplier, whichever is earlier.

Illustration 5: Assume that payment is recorded in the books of the supplier on 25th July 2018 and the date as per the bank statement is 27th July 2018. In this situation, the date of receipt of payment will be taken as 25th July 2018 as it will be earlier of the two events.

Continuous supply of services

As per Section 2(33) of the CGST Act 2017, continuous supply of services means a supply of services which is provided or agreed to be provided continuously or on recurrent basis under a contract for a period exceeding three months with periodic payment obligations and includes supply of services as the Government may subject to such conditions as it may by notification specify.

This means that there are three important conditions to be satisfied in order to be a continuous supply of services:

- a) The services should be provided continuously or on recurrent basis
- b) The contract period should be exceeding three months
- c) The payment obligations should be periodical

For instance an annual maintenance contract, construction contract etc. may be considered as continuous supply of services if the aforesaid conditions are satisfied. As stated in the context of goods, continuity of supply does not imply continuous supply. If each transaction is concluded satisfactorily, there cannot be a continuous supply. There must be something that cause the mere performance and insufficient to conclude the contractual performance of supplies. Merely delaying the invoicing cannot imply continuous supply.

The date of issuance of invoice in respect of continuous supply of services has been given under Section 31(5) of the CGST Act 2017 as follows:

- i. Where the due date of payment is ascertainable from the contract, the invoice will be issued on or before the due date of payment.
- ii. Where the due date of payment is not ascertainable from the contract, the invoice will be issued before or at the time when the supplier of services receives the payment
- iii. When the payment is linked to the completion of an event, the invoice will be issued on or before the date of completion of that event.

Illustration 6: Mr. X is getting construction services from a developer against buying of an under-construction flat for the period 01/07/2017 to 31/03/2018 for ₹ 150,00,000. The transactions are structured as follows:

Situation 1: Equal instalments to be paid at the end of every quarter

Periodic completion of service	Date of Invoice	Actual payment dates	Value
30-09-2017	03-10-2017	15-10-2017	50,00,000
31-12-2017	02-12-2017	03-02-2018	50,00,000
31-03-2018	10-04-2018	20-03-2018	50,00,000

Situation 2: Payment to be made as per mutual understanding

Periodic Completion of service	Date of Invoice	Actual payment dates	Value
31-12-2017	14-01-2018	12-01-2018	90,00,000
31-03-2018	22-04-2018	02-04-2018	60,00,000

Situation 3: 40% payment on 40% completion and balance payment on 100% completion

Periodic Completion of service	Date of Invoice	Actual payment dates	Value
01-10-2017	29-09-2017	05-10-2017	60,00,000
31-03-2018	24-04-2018	28-04-2018	90,00,000

Answer: This is a case of continuous supply of services. The first question that should be determined in these cases is whether the invoice is issued within the prescribed time period. If issued within the prescribed time period, the time of supply will be the date of issue of invoice or the date of receipt of payment whichever is earlier. If the invoice is issued after the prescribed period, then the time of supply will be the date of completion of service or the date of receipt of payment whichever is earlier.

Situation 1: In this situation, the due date of payment can be ascertainable from the contract. So, the last date of issuance of invoice will be the due date of payment. The due date of payment will be end of each quarter. So, the time of supply will be determinable as follows:

Periodic Completion of service	Date of Invoice	Actual payment dates	Value	Invoice issued within time limit	Time of supply
30-09-2017	03-10-2017	15-10-2017	50,00,000	No	30-09-2017
31-12-2017	02-12-2017	03-02-2018	50,00,000	Yes	02-12-2017
31-03-2018	10-04-2018	20-03-2018	50,00,000	No	20-03-2018

Situation 2: In this situation, due date of payment is not ascertainable from the contract. So, the invoice is to be issued before or at the time when the supplier of services receives the payment. So, the time of supply will be determinable as follows:

Periodic Completion of service	Date of Invoice	Actual payment dates	Value	Invoice issued within time limit	Time of supply
31-12-2017	14-01-2018	12-01-2018	90,00,000	Yes	12-01-2018
31-03-2018	22-04-2018	02-04-2018	60,00,000	No	31-03-2018

Situation 3: In this situation, the payment is linked to the completion of event. The invoice should be raised on or before the completion of that event (i.e. 40% or 100% completion as the case may be). So, the time of supply will be as follows:

Periodic Completion of service	Date of Invoice	Actual payment dates	Value	Invoice issued within time limit	Time of supply
01-10-2017	29-09-2017	05-10-2017	60,00,000	Yes	29-09-2017
31-03-2018	24-04-2018	28-04-2018	90,00,000	No	31-03-2018

Cessation of supply of services before the completion of the supply

As per Section 31(6) of the CGST Act 2017 where the supply of services ceases before the completion of the supply, the invoice is to be issued at the time when the supply ceases and such invoice shall be issued to the extent of the supply made before such cessation.

Illustration 7: A contract for supply of professional services was entered for ₹ 5,00,000 for the period of two months on 20th July 2017. However, on 16th August 2017, the recipient informed the supplier that he is not willing to receive any more services under the contract. Both of them mutually agree that the services provided till date can be valued at ₹ 3,50,000. The invoice for this was issued on 20th August 2018 and the payment was made by the recipient on 25th August 2018.

Answer: Here the cessation of supply of services occurs on 16th August 2017. The date by which the invoice should have been raised was also 16th August 2017. However, the invoice was issued on 20th August 2017 which is after the prescribed time period. So, the time of supply will be the earlier of the date of completion of service (16th August 2017) and the date of payment (25th August 2017) which will be 16th August 2017.

(b) Time of Supply – Reverse Charge

Where tax is payable on reverse charge basis, the time of supply is appointed to be the earlier of date of payment or 60 days from the date of issue of invoice by the supplier. If for any reason, one or all of these two dates cannot be determined then the time of supply will be the date of recording the supply in the books of the recipient.

In case of transactions between 'associated enterprises' where the supplier of service is located outside India, the date of recording the supply in the books of the recipient or the date of payment whichever is earlier, will be the time of supply.

Again, please note that in view of the definition of reverse charge in section 2(98), the above provision does not apply to payment of tax by an electronic commerce operator but only to those cases of supply which fall under sub-section 5 of section 9 of the Act.

Exceptions:

Date of receipt of payment shall be the date on which the payment is accounted in the books of the supplier or the date reflected in the bank account of the supplier, whichever is earlier.

Illustration 8: Mr. X provides legal services as an advocate to Mr.Y which fall under reverse charge basis.

10.04.2018 – The services are provided to Mr.Y

12.04.2018 – Mr. X issues an invoice to Mr.Y

10.07.2018 – The payment is made by Mr.Y through a cheque and recorded in his books of accounts

15.07.2018 – The payment gets debited from Mr. Y's bank account

What will be the time of supply?

Answer: The time of supply shall be earlier of the following dates:

The date of payment i.e. 10.07.2018 (earlier of 10.07.2018 and 15.07.2018)

The date immediately following sixty days from the date of issue of invoice i.e. 12.06.2018 (12.04.2018+60days+1day).

Therefore, the time of supply shall be 12.06.2018.

(c) Time of Supply – Vouchers

Please refer to discussion regarding time of supply of goods for some background discussion about actionable claims. For purposes of this discussion on time of supply of services, please note the following comments:

- (i) the discussion on actionable claims being includible as vouchers is relevant vis-à-vis services for the only reason that certain transactions involving goods are deliberately treated as supply of services by Schedule II and to this extent actionable claims which are a sub-set of goods need to be referred in this Chapter;
- (ii) vouchers are not entirely comprised only of actionable claims and services can also be included

Now, the time of supply in the case of vouchers is stated to be:

- (i) the date of issue of voucher if the supply is identifiable at that point; or
- (ii) in all other instances, the date of redemption of the voucher.

From the above provision, it can be seen that at the time of issue of voucher, it is possible that the supply is not identifiable. So, the following key statements can be considered in this regard:

- (i) Vouchers may be issued with specific or non-specific end-use;
- (ii) Vouchers are issued on payment of money;
- (iii) Vouchers themselves are not legal tender;
- (iv) Vouchers represent some carried value in money terms;
- (v) Vouchers are accepted as substitute for payment for a supply due to their carried value;
- (vi) Vouchers are not merely receipts for pre-payment received;
- (vii) Vouchers must be non-cancellable such that they cannot be reconverted back into money;
- (viii) Vouchers may be in physical or digital form but comprise the above characteristics.

When vouchers are issued for specific end-use, then they are taxable as supply provided they otherwise satisfy the requirements of section 7 of the Act. Since, a specific provision exists in respect of time of supply of vouchers, they are not goods or services in themselves, but are singled out for the limited purposes of prescribing the time of their supply. And the rate of tax will be that applicable to goods or services they are issued in respect of or that applicable at the time of redemption. Vouchers are not merely receipts for pre-payment received because prescribing a specific time of supply would be redundant when time of supply already considers advance payments.

Please also note that the Government has issued the Payment and Settlement Systems Act, 2007 ('PSS Act') and accordingly, not everyone is permitted to issue instruments that may be used as a Payment System. RBI is expected to make major changes to the circulars issued in terms of the PSS Act by June 2017 but the framework or principles borrowed from the current circulars for the purposes of GST is expected to remain unaltered although changes may come in areas of governance, ease of doing business and inclusive growth in e-payment offerings through these Pre-Paid Instruments or PPIs. (refer RBI Circular No.RBI/DPSS/2017-18/58 dated 11 Oct, 2017)

Description	Prepaid Payment Instruments (PSS Act, 2007)			Co-branded hybrid PPIs (7.4)	
	Closed	Semi-closed	Open	Semi-closed	Limited Open
Parties involved					
Issuer	Merchant	NBFC/Company	Bank	NBFC/Company	Bank
Brand	Issuer	Issuer	Issuer	Co-branded	Co-branded
Holder of PPI	Consumer	Consumer	Consumer	Consumer	Consumer
PPI usage	Issuer outlet only	Pre-defined outlets	Any or ATM	Any (or ATM)	Any (or ATM)
Description of PPI					
Card type	Physical only	e-Card only	Any	e-Card only	Any
Payment type (2.1)	Acceptance	Settlement	Settlement	Settlement	Settlement
Reload allowed	No	Yes	Yes	Yes	Yes
Is as 'payment system'	No (2.4)	Yes	Yes	Yes	Yes
Regulatory prescriptions					
RBI approval	Required	Required	Authorization	Required	Gen. permission
Stored value < Rs.100,000/-	Not allowed (7.1)	Full KYC (7.2-iii)	Full KYC (7.2-iii)	Full KYC (7.2-iii)	Full KYC (7.2-iii)
Stored value < Rs.50,000/-	OVD (7.2-ii) *	OVD (7.2-ii) *	Full KYC (7.2-iii)	OVD (7.2-ii) *	Full KYC (7.2-iii)
Stored value < Rs.10,000/-	ID only (7.2-i)	ID only (7.2-i)	Full KYC (7.2-iii)	ID only (7.2-i)	Full KYC (7.2-iii)
<small>* Officially valid document as per rule 2(d) of PML Rules, 2005</small>					
Cashflow / custody-flow steps					
Stored value paid by	Consumer	Consumer	Consumer	Consumer	Consumer
Stored value paid to	Issuer-merchant	Issuer	Issuer-bank	Issuer	Issuer-bank
Held as	Trade advance	Trade advance	Deposit	Trade advance	Deposit
Held with (8.2 & 8.3)	Any bank (escrow)	Any bank (escrow)	Issuer-bank	Any bank (escrow)	Issuer-bank
Held for (8.3-vii)	Issuer-merchant	Issuer	Consumer	Issuer	Consumer
Interest bearing account	No (8.3-xii)	No (8.3-xii)	Yes	No (8.3-xii)	Yes
'Lien or charge' of unspent value	Consumer	Consumer	No (8.2)	Consumer	No (8.2)
'Lien or charge' of spent value	Merchant	Merchant	Merchant	Merchant	Merchant
Unspent value stored (10.2 & .3)	Lapse & forfeit	Exhausts	Withdraw	Exhausts	Withdraw
Additional restrictions					
Resident of India	Yes	Yes	Any	Yes	Any
Non-commercial user	Yes	Yes	Any	Any	Any
Currency	INR only (6.3)	INR only (6.3)	Any (4.1)	INR only (6.3)	Any (4.1)
User verification	Nil (bearer use)	PIN-based	PIN-OTP	PIN-OTP-Others	PIN-OTP-Others

Source: Circular RBI/2014-2015/105 DPSS.CO.PD.PPI.No.3/02.14.006/2014-15 dated July 1, 2014 (updated as on Dec 3, 2014); relevant para references in brackets.

(d) Time of Supply – Residuary

Where none of the above provisions are able to satisfactorily answer the time of supply, it is to be determined based on the residuary provision which states that the time of supply is:

- (i) where a periodical return has to be filed, the due date prescribed for such return; or
- (ii) in any other case, the date of payment of the tax.

(e) Time of Supply – Special Charges

Sometimes there may be charges imposed by the supplier on account of some deviation or special circumstance from the expected terms of contract on the part of the recipient. These special charges may be enabled by the contract though not necessarily attracted at the time of supply of the underlying goods or service (other than these special charges) or may be agreed later – when the special circumstance occurs. These special charges are listed as interest, late fee or penalty on account of delay in payment of consideration. In these cases, the time of supply is appointed to be the date of receipt by the supplier.

Please note that even though a debit note may be issued after reaching agreement with the recipient about the special charges imposed, the time of supply continues to remain 'date of receipt' of payment towards such special charges. This is a departure from the provisions on

accrual principle in section 31. As this is a special provision, the same will prevail over all other general provisions.

It is important to understand that due to time of supply being prescribed, whether the imposition of these special charges is itself a supply or not? Please see the following comparative discussion:

Special Charges 'are' Supply	Special Charges 'are not' Supply
Special charges are also supply being agreeing to an act or forbear an act or to tolerate an act (Entry 5(e) of Schedule II) read with section 2(31)	There is no 'supply' in the case of interest, late fee or penalty as these special charges are a consequence of a departure from the agreed terms of contract and not in fulfilment thereof
Interest, late fee or penalty are illustrations only and such special charges by any other name would also be liable to GST but on receipt-basis	By accepting such an expansive interpretation, damages awarded by a Court, LD imposed in a contract, forfeiture of a EMD, etc. can become liable to GST as these are all in some way 'in the course or furtherance of business'
Special charges paid is liable to GST whether agreed before or agreed subsequently as satisfaction of the limited non-performance	Other than the three special charges listed, any other charges arising from a transaction is not liable to GST as it is not contemplated in the arrangement of supply although not imposed in all cases
Delay in payment is a primary deviation that gives rise to special charges but even deviation in time or quantity of supply can entail some other form of special charges, GST on those cannot be avoided as the these listed are only illustrative	Only 'delay in payment' gives rise to GST incidence on the special charges. Any other deviation would be a variation of contract to be independently examined if it satisfies definition of 'supply'
Special charges are 'linked' to an underlying supply (original supply) and therefore all forms of special charges would also be liable to GST	Special charges are 'linked' to an original supply as such GST cannot be imposed on special charges without an original supply

From the above discussion, several necessary conclusions need to be reached, namely:

- (i) whether the three listed charges are exhaustive or only illustrative?
- (ii) whether delay in payment is the only occasion when this provision is attracted or special charges imposed for any other default linked to the original supply will also attract this provision?

- (iii) whether special charges imposed for any other default (not delay in payment) is liable to GST but not on receipt basis but accrual basis or are special charges for these cases not at all liable to GST?

It appears that the three listed cases are exhaustive not by the three cases listed but the circumstance for their imposition – delay in payment of consideration. So, any form of special charges imposed is liable to GST on receipt basis but only if it is due to delay in payment of consideration. Special charges imposed due to any other default by the recipient is then to be examined if it is linked to an 'original supply' or is it by itself a supply? If linked to an original supply, it is also liable to tax but not during enjoying flexibility to pay tax on receipt basis and tax being payable based on the date of debit note. If not linked to an original supply, GST would not be applicable if it does not satisfy the requirements of levy.

The issues raised in respect of special charges may be considered as matter of discussion and does not carry a procurement of an opinion on view. Readers are free to connect on these discussions and evaluate each such situation after giving it adequate consideration or thought.

Some illustrations for better understanding of the provisions of time of supply of services

S. No.	Concept illustrations Section 13(2)	Invoice date	Invoice due date	Payment entry in supplier's books	Credit in bank account	Time of supply
1	Invoice raised before completion of service	10-Oct-17	20-Oct-17	26-Oct-17	30-Oct-17	10-Oct-17
2	Advance received	30-Oct-17	20-Oct-17	10-Oct-17	30-Oct-17	10-Oct-17

	Based on due date for invoicing Section 13(2) r/w Section 31(2) r/w Rule – 47 related to invoice	Invoice date	Commencement of service	Completion of service	Receipt of payment	Time of supply
3	Delayed issue of invoice	26-Dec-17	20-Oct-17	16-Nov-17	28-Jan-18	16-Nov-17
4	Advance received, invoice for full amount issued on same day (40% advance, 60% post supply payment)	30-Oct-17	30-Oct-17	30-Dec-17	30-Oct-17	30-Oct-17
04-Dec-17					30-Oct-17	

	Continuous supply of services Section 13(2) r/w Section 31(5)	Invoice date	Date as per contract	Receipt of payment	Entry of provision of services in books	Time of supply
5	Section 31(5)(a) Contract provides for payments monthly on the 10 th of succeeding month	02-Nov-17	10-Nov-17	15-Nov-17	31-Oct-17	02-Nov-17
		17-Dec-17	10-Dec-17	15-Dec-17	30-Nov-17	10-Dec-17
		10-Jan-18	10-Jan-18	06-Jan-18	31-Dec-17	06-Jan-18
6	Section 31(5)(c) Contract provides for payments on completion of event. Recipient to pay within 1 month from date of completion	12-Nov-17	10-Nov-17	25-Nov-17	12-Nov-17	10-Nov-17
		24-Apr-18	24-Apr-18	20-Apr-18	24-Apr-18	20-Apr-18

	Reverse charge Section 13(3)	Date of invoice issued by supplier	Date of completion of service	Payment by recipient	Entry of receipt of services in recipient's books	Time of supply
7	General	31-Oct-17	31-Oct-17	20-Nov-17	30-Nov-17	20-Nov-17
8	Advance paid	31-Oct-17	31-Oct-17	05-Nov-17	31-Oct-17	05-Nov-17
9	Delay in payment (Max. 60 days from date of invoice)	31-Oct-17	31-Oct-17	10-Jan-18	31-Oct-17	31-Dec-17
10	Service received from associated enterprise located outside India (No time extension allowed)	31-Oct-17	30-Nov-17	05-Apr-18	31-Mar-18	31-Mar-18
11	Service by unregistered person, no payment made	-	30-Nov-17	-	05-Dec-17	05-Dec-17

	Issue of vouchers Section 13(4) [or Section 12(4)]	First service/ delivery of goods	Issue of voucher	Redempti on of voucher	Last date for acceptan ce of voucher	Time of supply
12	Voucher issued to a recipient after supply of a service [or specific goods], for the same service - valid for 1 year	01-Nov-17	01-Nov-17	14-Dec-17	30-Oct-18	01-Nov-17
13	Voucher issued to a recipient of machinery along at the time of delivery, for availing repair services [or specific goods] worth ₹ 5,000 - valid for 1 year	01-Nov-17	01-Nov-17	14-Dec-17	30-Oct-18	01-Nov-17
14	Voucher issued to a recipient after supply of a service, for any other services or goods across India, - valid for 1 year	01-Nov-17	01-Nov-17	14-Dec-17	30-Oct-18	14-Dec-17
15	Gift voucher for ₹ 1,500 for services [or goods]- valid for 6 months	-	01-Nov-17	25-Dec-17	31-Mar-18	01-Nov-17

(f) Time of Supply – Consideration involving Development Rights or Construction Service

In case of Consideration involving Development Rights or Construction Service, the time of supply is specially notified vide notification 4/2018 – Central Tax (R) dated 25.01.2018, under the powers conferred by Sec 148 of the CGST Act. Accordingly the liability to pay tax in certain situations would be as below:

Situation	Event requiring payment of taxes
Registered persons supplying development rights to a developer, builder, construction company or any other registered person against consideration, wholly or partly, in the form of construction service of complex, building or civil structure	On transfer of possession or the right in the constructed complex, building or civil structure, to the person supplying the development rights by entering into a conveyance deed or similar instrument (for example allotment letter).
Registered persons supplying construction service of complex, building or civil structure to supplier of development rights against consideration, wholly or partly, in the form of transfer of development rights.	

If a registered builder supplies construction service in consideration of receiving development rights from the owner, then the liability would arise for as a continuous supply of construction service through the construction duration and completed on the date of handing over.

If a registered landowner supplies development rights in consideration of construction service received from builder, then the liability would arise for immediately upon entering into an irrevocable agreement for supply of development rights although consideration in the form of constructed area is handed over much later.

Now, where 4/2018-CT is applicable, the time of supply is deferred until handing over. But, please note that where non-refundable deposit (NRD) is paid by builder to landowner or where landowner starts to sell apartment units (that are under construction), then the time of supply will not be deferred but get advanced to these earlier events of collection of NRD or booking agreement to end customers.

Further, where joint-development agreement are not on 'area sharing' basis but on 'revenue sharing' basis, then firstly, 4/2018-CT will not apply as this notification only provides deferment of time of supply when there is an exchange. And when builder is liable to pay cash (for development rights supply), time of supply will be the time when builder is put in possession of the land. Please note that the landowner does not put the builder in possession of the land again-and-again but at one-go, when the irrevocable agreement is executed and registered. As such, the supply of development rights is at the start of the project. But the credit to the builder will be subject to rule 37, that is, only to the extent payment if made by the

builder for the inward supply (of development rights) by the landowner. There is one view that supply of development rights (in case of revenue sharing development) can be treated as continuous supply so that builder is entitled to credit to the extent of each payment instalment that is made. On this, no clear view is available from the tax administration but review of the concept of continuous supply and the irrevocable development agreement may throw some light.

Statutory Provisions

14. Change in rate of tax in respect of supply of goods or services

Notwithstanding anything contained in section 12 or section 13, the time of supply, where there is a change in the rate of tax in respect of goods or services or both, shall be determined in the following manner, namely: —

- (a) in case the goods or services or both have been supplied before the change in rate of tax, —
 - (i) where the invoice for the same has been issued and the payment is also received after the change in rate of tax, the time of supply shall be the date of receipt of payment or the date of issue of invoice, whichever is earlier; or
 - (ii) where the invoice has been issued prior to the change in rate of tax but payment is received after the change in rate of tax, the time of supply shall be the date of issue of invoice; or
 - (iii) where the payment has been received before the change in rate of tax, but the invoice for the same is issued after the change in rate of tax, the time of supply shall be the date of receipt of payment;
- (b) in case the goods or services or both have been supplied after the change in rate of tax, —
 - (i) where the payment is received after the change in rate of tax but the invoice has been issued prior to the change in rate of tax, the time of supply shall be the date of receipt of payment; or
 - (ii) where the invoice has been issued and payment is received before the change in rate of tax, the time of supply shall be the date of receipt of payment or date of issue of invoice, whichever is earlier; or
 - (iii) where the invoice has been issued after the change in rate of tax but the payment is received before the change in rate of tax, the time of supply shall be the date of issue of invoice:

Provided that the date of receipt of payment shall be the date of credit in the bank account if such credit in the bank account is after four working days from the date of change in the rate of tax.

Explanation. —For the purposes of this section, “the date of receipt of payment” shall be the date on which the payment is entered in the books of account of the supplier or the date on which the payment is credited to his bank account, whichever is earlier.

Relevant circulars, notifications, clarifications issued by Government:

1. Notification No. 9/2017 – Central Tax dated 28.06.2017 Seeks to appoint 01.07.2017 as the date on which the provisions of Section 12 are effective.
2. Notification No. 66/2017 – Central Tax dated 15.11.2017 Seeks to exempt all taxpayers from payment of tax on advances received in case of supply of goods (*This notification is issued superseding the earlier Notification No. 40/2017 – Central Tax dated 13.10.2017 wherein the exemption from payment of tax on receipt of advances was extended to a registered person whose aggregate turnover is less than ₹ 1.5 crores*);

Related provisions of the Statute

Section or Rule (CGST / SGST)	Description
Section 2(66)	Definition of Tax Invoice or Invoice
Section 2(52)	Definition of Goods
Section 2(102)	Definition of Services
Section 2(105)	Definition of Supplier
Section 7	Scope of Supply
Section 31	Tax invoice, credit note and debit note

14.1 Analysis

Payment of tax requires the presence of all the following events:

- (i) supply of goods or services
- (ii) issue of invoice
- (iii) payment for the supply

When there is a change in the rate of tax during the occurrence of these three events, there may be some concern about the applicability of the correct rate of tax. Section 14 addresses this aspect clearly.

Where the supply takes place after the change in the rate of tax, the time of supply may be as follows:

(a) Supply before the cut-off date-say 01-Sep- 18

Supply	Invoice	Payment	Point of taxation
25.08.2018	01.09.2018	05.09.2018	01.09.2018 (Invoice or payment, whichever is earlier)
25.08.2018	26.08.2018	05.09.2018	26.08.2018(Date of Invoice)
25.08.2018	01.09.2018	27.08.2018	27.08.2018(Date of payment)

(b) Supply after the cut-off date-say 01-Sep-17

Supply	Invoice	Payment	Point of taxation
01.09.2017	25.08.2017	05.09.2017	05.09.2017(Date of payment)
01.09.2017	25.08.2017	26.08.2017	25.08.2017 (Date of invoice or date of payment, whichever is earlier)
01.09.2017	02.09.2017	26.08.2017	02.09.2017(Date of Invoice)

It is relevant to note here that the Notification 66/2017-CT dated 15.11.2017 exempting a taxable person from payment of tax on advances received refers to the scenarios enumerated in section 14. This may not mean that the receipt of payment in advance should not be considered for determining the change in tax rate; since, the said notification will have limited application for ascertaining the time of supply of goods. In other words, section 12 specifies the scenarios for ascertaining time of supply whereas section 14 specifies the point of determination of appropriate rate of tax. This means that on application of the said notification, if the date of receipt of advance is relevant, the payment of tax may be deferred till the date of supply of goods at the rate applicable as on the date of receipt of advance (point of taxation).

Although supply has not yet taken place, the time of supply determined as above is valid and not in violation of the levy of GST for the following reasons:

- (i) Supply is defined in section 7(1)(a) as '.....made or agreed to be made.....'
- (ii) Levy of GST in section 9 is on such supply, that is, 'made or agreed to be made'

Prescribing the time of supply anterior to the time of actual supply is well accommodated in the language of the Act.

Chapter 5

Value of Supply

Sections	Rules
15. Value of taxable supply	27 Value of supply of goods or services where the consideration is not wholly in money 28 Value of supply of goods or services or both between distinct or related persons, other than through an agent 29 Value of supply of goods made or received through an agent 30 Value of supply of goods or services or both based on cost 31 Residual method for determination of value of supply of goods or services or both 31A Value of supply in case of lottery, betting, gambling and horse racing. 32 Determination of value in respect of certain supplies 33 Value of supply of services in case of pure agent 34 Rate of exchange of currency, other than Indian rupees, for determination of value 35 Value of supply inclusive of integrated tax, central tax, State tax, Union territory tax

Statutory Provisions

15. Value of taxable supply

- (1) *The value of a supply of goods or services or both shall be the transaction value, which is the price actually paid or payable for the said supply of goods or services or both where the supplier and the recipient of the supply are not related and the price is the sole consideration for the supply.*

- (2) *The value of supply shall include—*
- (a) *any taxes, duties, cesses, fees and charges levied under any law for the time being in force other than this Act, the State Goods and Services Tax Act, the Union Territory Goods and Services Tax Act and the Goods and Services Tax (Compensation to States) Act, if charged separately by the supplier;*
 - (b) *any amount that the supplier is liable to pay in relation to such supply but which has been incurred by the recipient of the supply and not included in the price actually paid or payable for the goods or services or both;*
 - (c) *incidental expenses, including commission and packing, charged by the supplier to the recipient of a supply and any amount charged for anything done by the supplier in respect of the supply of goods or services or both at the time of, or before delivery of goods or supply of services;*
 - (d) *interest or late fee or penalty for delayed payment of any consideration for any supply; and*
 - (e) *subsidies directly linked to the price excluding subsidies provided by the Central Government and State Governments.*
- Explanation.—For the purposes of this sub-section, the amount of subsidy shall be included in the value of supply of the supplier who receives the subsidy.*
- (3) *The value of the supply shall not include any discount which is given—*
- (a) *before or at the time of the supply if such discount has been duly recorded in the invoice issued in respect of such supply; and*
 - (b) *after the supply has been effected, if—*
 - (i) *such discount is established in terms of an agreement entered into at or before the time of such supply and specifically linked to relevant invoices; and*
 - (ii) *input tax credit as is attributable to the discount on the basis of document issued by the supplier has been reversed by the recipient of the supply.*
- (4) *Where the value of the supply of goods or services or both cannot be determined under sub-section (1), the same shall be determined in such manner as may be prescribed.*
- (5) *Notwithstanding anything contained in sub-section (1) or sub-section (4), the value of such supplies as may be notified by the Government on the recommendations of the Council shall be determined in such manner as may be prescribed.*
- Explanation.—For the purposes of this Act,—*
- (a) *persons shall be deemed to be “related persons” if—*
 - (i) *such persons are officers or directors of one another’s businesses;*
 - (ii) *such persons are legally recognised partners in business;*
 - (iii) *such persons are employer and employee;*

- (iv) any person directly or indirectly owns, controls or holds twenty-five per cent. or more of the outstanding voting stock or shares of both of them;
- (v) one of them directly or indirectly controls the other;
- (vi) both of them are directly or indirectly controlled by a third person;
- (vii) together they directly or indirectly control a third person; or
- (viii) they are members of the same family;
- (b) the term "person" also includes legal persons;
- (c) persons who are associated in the business of one another in that one is the sole agent or sole distributor or sole concessionaire, howsoever described, of the other, shall be deemed to be related.

Extract of the CGST Rules 2017**27. Value of supply of goods or services where the consideration is not wholly in money**

Where the supply of goods or services is for a consideration not wholly in money, the value of the supply shall,-

- (a) be the open market value of such supply;
- (b) if the open market value is not available under clause (a), be the sum total of consideration in money and any such further amount in money as is equivalent to the consideration not in money, if such amount is known at the time of supply;
- (c) if the value of supply is not determinable under clause (a) or clause (b), be the value of supply of goods or services or both of like kind and quality;
- (d) if the value is not determinable under clause (a) or clause (b) or clause (c), be the sum total of consideration in money and such further amount in money that is equivalent to consideration not in money as determined by the application of rule 30 or rule 31 in that order.

Illustration:

- (1) Where a new phone is supplied for twenty thousand rupees along with the exchange of an old phone and if the price of the new phone without exchange is twenty four thousand, the open market value of the new phone is Rs 24000.
- (2) Where a laptop is supplied for forty thousand rupees along with a barter of printer that is manufactured by the recipient and the value of the printer known at the time of supply is four thousand rupees but the open market value of the laptop is not known, the value of the supply of laptop is forty four thousand rupees.

28. Value of supply of goods or services or both between distinct or related persons, other than through an agent

The value of the supply of goods or services or both between distinct persons as specified in sub-section (4) and (5) of section 25 or where the supplier and recipient are related, other than where the supply is made through an agent, shall-

- (a) be the open market value of such supply;
- (b) if the open market value is not available, be the value of supply of goods or services of like kind and quality;
- (c) if the value is not determinable under clause (a) or (b), be the value as determined by the application of rule 30 or rule 31, in that order:

Provided that where the goods are intended for further supply as such by the recipient, the value shall, at the option of the supplier, be an amount equivalent to ninety percent of the price charged for the supply of goods of like kind and quality by the recipient to his customer not being a related person:

Provided further that where the recipient is eligible for full input tax credit, the value declared in the invoice shall be deemed to be the open market value of the goods or services.

29. Value of supply of goods made or received through an agent

The value of supply of goods between the principal and his agent shall:

- (a) be the open market value of the goods being supplied, or at the option of the supplier, be ninety per cent. of the price charged for the supply of goods of like kind and quality by the recipient to his customer not being a related person, where the goods are intended for further supply by the said recipient.

Illustration:

A principal supplies groundnut to his agent and the agent is supplying groundnuts of like kind and quality in subsequent supplies at a price of five thousand rupees per quintal on the day of the supply. Another independent supplier is supplying groundnuts of like kind and quality to the said agent at the price of four thousand five hundred and fifty rupees per quintal. The value of the supply made by the principal shall be four thousand five hundred and fifty rupees per quintal or where he exercises the option, the value shall be 90 per cent. of five thousand rupees i.e., four thousand five hundred rupees per quintal.

- (b) where the value of a supply is not determinable under clause (a), the same shall be determined by the application of rule 30 or rule 31 in that order.

30. Value of supply of goods or services or both based on cost

Where the value of a supply of goods or services or both is not determinable by any of the

preceding rules of this Chapter, the value shall be one hundred and ten percent of the cost of production or manufacture or the cost of acquisition of such goods or the cost of provision of such services.

31. Residual method for determination of value of supply of goods or services or both

Where the value of supply of goods or services or both cannot be determined under rules 27 to 30, the same shall be determined using reasonable means consistent with the principles and the general provisions of section 15 and the provisions of this Chapter:

Provided that in the case of supply of services, the supplier may opt for this rule, ignoring rule 30.

31A. Value of supply in case of lottery, betting, gambling and horse racing.-

- (1) Notwithstanding anything contained in the provisions of this Chapter, the value in respect of supplies specified below shall be determined in the manner provided hereinafter.
- (2)
 - (a) The value of supply of lottery run by State Governments shall be deemed to be 100/112 of the face value of ticket or of the price as notified in the Official Gazette by the organising State, whichever is higher.
 - (b) The value of supply of lottery authorised by State Governments shall be deemed to be 100/128 of the face value of ticket or of the price as notified in the Official Gazette by the organising State, whichever is higher.

Explanation:- For the purposes of this sub-rule, the expressions-

- (a) "lottery run by State Governments" means a lottery not allowed to be sold in any State other than the organizing State;
 - (b) "lottery authorised by State Governments" means a lottery which is authorised to be sold in State(s) other than the organising State also; and
 - (c) "Organising State" has the same meaning as assigned to it in clause (f) of sub-rule (1) of rule 2 of the Lotteries (Regulation) Rules, 2010.
- (3) The value of supply of actionable claim in the form of chance to win in betting, gambling or horse racing in a race club shall be 100% of the face value of the bet or the amount paid into the totalisator.

32. Determination of value in respect of certain supplies

- (1) Notwithstanding anything contained in the provisions of this Chapter, the value in respect of supplies specified below shall, at the option of the supplier, be determined in the manner provided hereinafter.
- (2) The value of supply of services in relation to the purchase or sale of foreign currency, including money changing, shall be determined by the supplier of services in the following manner, namely:-

- (a) For a currency, when exchanged from, or to, Indian Rupees, the value shall be equal to the difference in the buying rate or the selling rate, as the case may be, and the Reserve Bank of India reference rate for that currency at that time, multiplied by the total units of currency:

Provided that in case where the Reserve Bank of India reference rate for a currency is not available, the value shall be one per cent. of the gross amount of Indian Rupees provided or received by the person changing the money:

Provided further that in case where neither of the currencies exchanged is Indian Rupees, the value shall be equal to one per cent. of the lesser of the two amounts the person changing the money would have received by converting any of the two currencies into Indian Rupee on that day at the reference rate provided by the Reserve Bank of India.

Provided also that a person supplying the services may exercise the option to ascertain the value in terms of clause (b) for a financial year and such option shall not be withdrawn during the remaining part of that financial year.

- (b) At the option of the supplier of services, the value in relation to the supply of foreign currency, including money changing, shall be deemed to be-
- (i) one per cent. of the gross amount of currency exchanged for an amount up to one lakh rupees, subject to a minimum amount of two hundred and fifty rupees;
 - (ii) one thousand rupees and half of a per cent. of the gross amount of currency exchanged for an amount exceeding one lakh rupees and up to ten lakh rupees; and
 - (iii) Five thousand and five hundred rupees and one tenth of a per cent. of the gross amount of currency exchanged for an amount exceeding ten lakh rupees, subject to a maximum amount of sixty thousand rupees.
- (3) The value of the supply of services in relation to booking of tickets for travel by air provided by an air travel agent shall be deemed to be an amount calculated at the rate of five per cent. of the basic fare in the case of domestic bookings, and at the rate of ten per cent. of the basic fare in the case of international bookings of passage for travel by air.
- Explanation.- For the purposes of this sub-rule, the expression "basic fare" means that part of the air fare on which commission is normally paid to the air travel agent by the airlines.*
- (4) The value of supply of services in relation to life insurance business shall be,-
- (a) the gross premium charged from a policy holder reduced by the amount allocated

for investment, or savings on behalf of the policy holder, if such an amount is intimated to the policy holder at the time of supply of service;

- (b) in case of single premium annuity policies other than (a), ten per cent. of single premium charged from the policy holder; or*
- (c) in all other cases, twenty five per cent. of the premium charged from the policy holder in the first year and twelve and a half per cent. of the premium charged from the policy holder in subsequent years:*

Provided that nothing contained in this sub-rule shall apply where the entire premium paid by the policy holder is only towards the risk cover in life insurance.

- (5) Where a taxable supply is provided by a person dealing in buying and selling of second hand goods i.e., used goods as such or after such minor processing which does not change the nature of the goods and where no input tax credit has been availed on the purchase of such goods, the value of supply shall be the difference between the selling price and the purchase price and where the value of such supply is negative, it shall be ignored:*

Provided that the purchase value of goods repossessed from a defaulting borrower, who is not registered, for the purpose of recovery of a loan or debt shall be deemed to be the purchase price of such goods by the defaulting borrower reduced by five percentage points for every quarter or part thereof, between the date of purchase and the date of disposal by the person making such repossession.

- (6) The value of a token, or a voucher, or a coupon, or a stamp (other than postage stamp) which is redeemable against a supply of goods or services or both shall be equal to the money value of the goods or services or both redeemable against such token, voucher, coupon, or stamp.*
- (7) The value of taxable services provided by such class of service providers as may be notified by the Government, on the recommendations of the Council, as referred to in paragraph 2 of Schedule I of the said Act between distinct persons as referred to in section 25, where input tax credit is available, shall be deemed to be NIL.*

33. Value of supply of services in case of pure agent

Notwithstanding anything contained in the provisions of this Chapter, the expenditure or costs incurred by a supplier as a pure agent of the recipient of supply shall be excluded from the value of supply, if all the following conditions are satisfied, namely,-

- (i) the supplier acts as a pure agent of the recipient of the supply, when he makes the payment to the third party on authorisation by such recipient;*
- (ii) the payment made by the pure agent on behalf of the recipient of supply has been separately indicated in the invoice issued by the pure agent to the recipient of service; and*

(iii) *the supplies procured by the pure agent from the third party as a pure agent of the recipient of supply are in addition to the services he supplies on his own account.*

Explanation.- For the purposes of this rule, the expression "pure agent" means a person who-

- (a) *enters into a contractual agreement with the recipient of supply to act as his pure agent to incur expenditure or costs in the course of supply of goods or services or both;*
- (b) *neither intends to hold nor holds any title to the goods or services or both so procured or supplied as pure agent of the recipient of supply;*
- (c) *does not use for his own interest such goods or services so procured; and*
- (d) *receives only the actual amount incurred to procure such goods or services in addition to the amount received for supply he provides on his own account.*

Illustration

Corporate services firm A is engaged to handle the legal work pertaining to the incorporation of Company B. Other than its service fees, A also recovers from B, registration fee and approval fee for the name of the company paid to the Registrar of Companies. The fees charged by the Registrar of Companies for the registration and approval of the name are compulsorily levied on B. A is merely acting as a pure agent in the payment of those fees. Therefore, A's recovery of such expenses is a disbursement and not part of the value of supply made by A to B.

34. Rate of exchange of currency, other than Indian rupees, for determination of value

- (1) *The rate of exchange for determination of value of taxable goods shall be the applicable rate of exchange as notified by the Board under section 14 of the Customs Act, 1962 for the date of time of supply of such goods in terms of section 12 of the Act.*
- (2) *The rate of exchange for determination of value of taxable services shall be the applicable rate of exchange determined as per the generally accepted accounting principles for the date of time of supply of such services in terms of section 13 of the Act.*

35. Value of supply inclusive of integrated tax, central tax, State tax, Union territory tax

Where the value of supply is inclusive of integrated tax or, as the case may be, central tax, State tax, Union territory tax, the tax amount shall be determined in the following manner, namely,-

Tax amount = (Value inclusive of taxes X tax rate in % of IGST or, as the case may be, CGST, SGST or UTGST) ÷ (100+ sum of tax rates, as applicable, in %).

Explanation.- For the purposes of the provisions of this Chapter, the expressions-

- (a) “open market value” of a supply of goods or services or both means the full value in money, excluding the integrated tax, central tax, State tax, Union territory tax and the cess payable by a person in a transaction, where the supplier and the recipient of the supply are not related and the price is the sole consideration, to obtain such supply at the same time when the supply being valued is made;
- (b) “supply of goods or services or both of like kind and quality” means any other supply of goods or services or both made under similar circumstances that, in respect of the characteristics, quality, quantity, functional components, materials, and the reputation of the goods or services or both first mentioned, is the same as, or closely or substantially resembles, that supply of goods or services or both.

Relevant circulars, notifications, clarifications issued by Government:

1. Notification No. 9/2017 – Central Tax dated 28.06.2017 Seeks to appoint 01.07.2017 as the date on which the provisions of Section 12 are effective;
2. Circular F. No. 354/107/2017-TRU dated 04.01.2018 clarifying the value of services for payment of tax.
3. Circular No. 73/47/2018-GST dated 05-11-2018 clarifying the Scope of principal and agent relationship under Schedule I of CGST Act, 2017 in the context of del-credere agent and the valuation to be adopted
4. Circular No. 47/21/2018-GST, dated 8-6-2018 clarifying inclusion of cost of moulds and dies owned by Original Equipment Manufacturers (OEM) and are sent free of cost (FOC) to a component manufacturer

Related provisions of the Statute:

Section or Rule (CGST / SGST)	Description
Section 2(1)	Definition of Actionable Claim
Section 2(5)	Definition of Agent
Section 2(17)	Definition of Business
Section 2(31)	Definition of Consideration
Section 2(52)	Definition of Goods
Section 2(73)	Definition of Market value
Section 2(93)	Definition of Recipient
Section 7	Scope of Supply
Section 9	Levy and Collection
Rule 27	Value of supply of goods or services where the consideration is not wholly in money

Rule 28	Value of supply of goods or services or both between distinct or related persons, other than through an agent
Rule 29	Value of supply of goods made or received through an agent
Rule 30	Value of supply of goods or services or both based on cost
Rule 31	Residual method for determination of value of supply of goods or services or both
Rule 31A	Value of supply in case of lottery, betting, gambling and horse racing
Rule 32	Determination of value in respect of certain supplies
Rule 33	Value of supply of services in case of pure agent
Rule 34	Rate of exchange of currency, other than Indian rupees, for determination of value
Rule 35	Value of supply inclusive of integrated tax, central tax, State tax, Union territory tax

15.1. Introduction

Consideration is *quid pro quo* in a contract and price is the consideration expressed in money terms. Value is the price prevalent when a transaction takes place under controlled conditions. Valuation is the study of all those circumstances and assessment of steps to reverse or rectify the effect of contractual or other arrangements that may suppress or understate the value of the transaction.

15.2. Analysis

This section applies to both goods and services supplied for purposes of valuation of the taxable supply.

Although contained in the CGST Act, the valuation method provided in this section applies to UTGST, SGST, CGST and IGST. Valuation must be as provided exclusively in this section.

Transaction value should be taken for the purpose of valuation under GST. "Transaction value" has been explained in the section as the price actually paid or payable for the supply of goods and/or services or both where the supplier and the recipient of the supply are not related and the price is the sole consideration for the supply. From this, it can be gathered that there should be a clear nexus between the supply of goods or services and the amount received by the supplier of goods or services. If no linkage can be established between the price paid or payable and the supply of goods/services, the inclusion of the price within the valuation may be called into question. For this, the contractual terms and obligations of the supplier and the recipient should be examined to evaluate whether nexus between the supply and the price paid/payable against it can be established. For instance, in a contract of job work, value of material given by the manufacturer to the job worker will not be considered for the purpose of GST. This is because the contract involved the supply of services by job

worker only against which the price is paid by the manufacturer. There is no supply of material involved which can be attributable to the price paid/payable,

Price is consideration in money terms. Value, as stated earlier, is price that would be prevalent under controlled conditions. These conditions being:

- Transaction having a price
- Between persons not related
- And that price being the sole consideration

In other words, the exercise of valuation is aimed to recreate the above conditions and take any given transaction through to see the result – price – that would emerge.

As discussed above, for assuming price as the valuation mechanism, two important aspects should be considered – supplier and recipient are not related and the fact that price is the sole consideration.

Situations when the supplier and recipient will be considered as related have been enumerated in Explanation to Section 15(5) of the CGST Act 2017. They are deemed to be related persons if:

- (i) such persons are officers or directors of one another's businesses;
- (ii) such persons are legally recognised partners in business;
- (iii) such persons are employer and employee;
- (iv) any person directly or indirectly owns, controls or holds twenty-five per cent. or more of the outstanding voting stock or shares of both of them;
- (v) one of them directly or indirectly controls the other;
- (vi) both of them are directly or indirectly controlled by a third person;
- (vii) together they directly or indirectly control a third person; or
- (viii) they are members of the same family;

Further, it has been stated that the word 'person' will also be including legal persons as per the comprehensive definition given under Section 2(84) of the CGST Act. Also, it has been stated that the persons who are associated with business of one another as sole agent or sole distributor or sole concessionaire will also be deemed to be related persons.

It is pertinent here that the term price is the sole consideration should be understood. If there is any consideration in non-monetary form, only the price actually paid cannot be taken as the basis of valuation. In this situation, price cannot be called as the sole consideration. In fact any additional consideration received apart from the monetary consideration should also be considered to arrive at the proper value. The fact that the consideration can be both monetary and non-monetary can very well be inferred from the definition of consideration given as per Section 2(31) of the CGST Act. Further, the payment against the supply made either by the

recipient directly or by another person will both be covered within the ambit of consideration and considered as part of the price for the purpose of valuation. This can be elaborated by an example. Let's say the supplier supplies goods worth ₹ 5,00,000 to the recipient. Against this supply, ₹ 3,00,000 is paid by the recipient directly and balance ₹ 2,00,000 is paid by the recipient's debtor. Both the payments will be included in the price for the purpose of valuation under GST.

For determination of the taxable value, classification between deposits and advances should be interpreted diligently. Advances refers to payment as part of consideration of an agreement before the supplier performs his obligation under the said agreement. It is not provided with an intent of refunding unlike deposit. Advance is treated to be part of the consideration to the contract and thereby includible within the taxable value. A deposit can be described as an amount given to the supplier with an obligation entrusted upon the supplier to keep it safely. The essence of the deposit is that there must be a liability to return it to the party by whom or on whose behalf it is made upon fulfilment of certain conditions or to apply it as consideration at a future date depending on the terms of the contract. Till the deposit is classifiable as such, it does not form part of the taxable value. As and when this deposit is applied as consideration under the contract against the supply made or agreed to be made, it forms part of the taxable value. Retention money is a classic example of deposit. To elaborate, the recipient may withhold a certain part of the consideration payable to a supplier and keeps a part of that amount as deposit with himself. Only when the given obligations are discharged by the supplier as per the terms of the contract, this retention money is released. This retention money is not included in the value if returned as such to the supplier. However, if the supplier fails to fulfil the given obligations as per the contract, the recipient may charge the said retention money and apply it against the default. When applied, the said retention money becomes chargeable to tax. It may be pertinent to point out here that the money retained will not reduce the value of the original contract of supply. This means the principal supply will continue to be valued at the full amount without any deduction for the retention money. Another example that can be taken here is that of a rent agreement. Let us assume that a tenant is required to pay a three months deposit to the landlord in an eleven months contract. Upon default of the rent of any one month, the deposit is partly deducted as the rental for that month. Only to the extent of such deduction towards the rent of that month, it will be considered as part of the taxable value. Further, deposit is not chargeable to tax under normal circumstances unless applied as consideration. So, there may be a tendency towards classification of the taxable advance as deposit. However, any such classification should not be made based on the nomenclature of the payment only. Based on the nature of business, frequency, application and intent of such payments etc., it may be susceptible to challenge by the Governmental authorities. The subtlety involved in classification of payments between advance and deposit should be carefully analysed in terms of the contract and as per customary practises to determine the correct nature of the payment.

In addition to the price, certain express checks to be carried out that can disqualify a price that is otherwise perfectly admissible are provided:

- Taxes levied under any other law(s)- this clause provides for exclusion of GST from the value and therefore all other taxes charged must be included in the value before quantifying GST. Taxes other than GST will cause cascading and this is deliberate. For instance, on import of goods IGST is charged not only on the value of goods but the basic customs duty paid under the Customs law.
- Any amounts paid by recipient that are obligation of supplier to pay- this clause removes any doubt about the need to include costs paid by the recipient to a third party in the value of supply by the supplier. The prescription in this clause is to identify any occasion where costs – in respect of which the supplier is the principal creditor / obligor – are diverted away from the principal such that the recipient directly makes the payment resulting in lowering the rightful value of supply. At the same time, this clause does not authorize every payment where the recipient is the principal creditor / obligor and require these also to be included in the value of supply.

CBIC vide Circular no. 47/21/2018-GST, dated 8-6-2018 has clarified that if the contract between OEM and component manufacturer was for supply of components made by using the moulds/dies belonging to the component manufacturer, but the same have been supplied by the OEM to the component manufacturer on FOC basis, the amortised cost of such moulds/dies shall be added to the value of the components.

This point may be illustrated by an example of – payment of commission to agent for facilitating the supply. If the payment is ‘buying commission’ which is paid by the recipient, then the obligation to pay the agent is always of the recipient and does not require to be included in the value of supply. But if the payment is ‘selling commission’ which happens to be paid by the recipient, then the obligation to pay the agent being that of the supplier is required to be included in the value of supply. In this case (of selling commission), the underlying obligation is that of the supplier because it is the supplier who engages the agent to identify customers to make a supply. And if, somehow, the supplier manages to pass this obligation to pay the agent (the amount towards selling commission) to the recipient, then the price paid to supplier is not the true value of supply. Had the recipient refused to pay this selling commission to the agent, then the supplier would have paid the agent and made a corresponding increase in the price of the supply. It is this objective that is being achieved by this clause.

Another example can be of a free on road contract wherein the payment of transportation charges is directly made by the recipient and the value to be paid to the supplier by the recipient is reduced to that extent. In this case, the transportation charges which was reduced from the price payable will be added back to the taxable value. There are several other examples that can be considered, please also refer to the discussion on value of supply for further illustration on this point.

“transaction value” which is the price actually paid or payable for the said supply of goods and/or services or both where the supplier and the recipient of the supply are not related and the price is the sole consideration for the supply.

- Incidental expenses charged by the supplier- this clause addresses a completely different aspect compared to the previous clause. Here, costs that the supplier incurs 'at' or 'before' supply are liable to be included in the value of supply. For example, cost of packing and transportation has been debated under the VAT laws whether they are incurred before or after the 'transfer of property'. In GST, the point when title passes is irrelevant. To address the issues that had been so vigorously debated under VAT laws, this clause lays down that any cost that the supplier incurs including commission and packing which is charged to the recipient will be included in the value of supply. With this clause there is no opportunity to claim that certain charges recovered by the supplier 'after supply' are not to be included in the value of supply. Also incidental expenses like home delivery charges are includible in the value of supply when food is delivered by a restaurant to a customer's home. Another example can be the extra bed charges included by a hotel in the value in case of accommodation services provided by a hotel to a customer. Yet another example can be installation of new modular furniture at office wherein the installation expenses are recovered separately by the supplier. Special packing charges by a gift shop while selling a show piece can also be a pertinent illustration here. If it is a charge recovered from the recipient, then the same is includible in the value of supply provided it is not incurred 'after' the completion of supply. An example of cost incurred after date of supply yet not liable to be included in the value of supply could be amount of input tax credit, considered as eligible in pricing of supply, but denied to the supplier by (say) section 16(4). And an example of a cost incurred by the supplier after the date of supply but still includible could be cost of in-warranty parts (actual or scientifically estimated provision) supplied after the date of supply.
- Interest, late fee or penalty for delayed payment- this would also have been a charge recovered by the supplier 'after' the supply that would not be includible in the value of supply but due to the express words of this clause will be included. Please refer detailed discussion regarding this clause under time of supply as 'special charges' under section 12(6) / 13(6) where characterization of these charges as well as their rate of tax (supply-dependent or independent) are addressed. For example, Mr. X enters into a contract for supply of goods worth ₹ 2,00,000 on 15th March 2018. As per the said contract, a payment of the said amount was required to be made within 2 months of the sale. If the complete payment is not made within this time period, a late penalty of ₹ 10,000 will be chargeable. Let us assume that the payment is not made within the said period. In this situation, ₹ 10,000 will be includible in the taxable value.
- Subsidy realized by supplier on the supply- this clause expressly provides for the limited exclusion of subsidy from value of supply, that is, subsidy given by the Government alone is excluded from value of supply. This clause makes an interesting requirement that any transaction where there is any form of price-intervention that behaves like a 'subsidy' is liable to be included in the value of supply. In today's economy, there are many transactions that 'behave like subsidy'. For example, contribution of consideration

by third party to contract, incentive to supplier given by brand holder linked to each supply, etc. Please note, extended credit terms to one customer and upfront payment terms to another customer cannot be interfered with by relying on this clause. There appears to be no room to include 'notional additions' by this clause because unlike Central Excise which relies upon 'assessable value' for quantifying the duty, GST relies upon 'transaction value' for quantification. Also, please note 'no cost EMI' and 'cash back' are a form of price-intervention by third party but not included in this clause because these forms of price-intervention is reaching the recipient of supply and not the supplier. The condition for inclusion is also that the subsidy should be directly linked to the price. If the subsidy is provided in a manner which cannot be directly linked to the price of the product in question, then that amount cannot be included for the determination of taxable value. For instance, subsidy against a capital asset does not affect the value of the product directly and hence not includible in the price. However, all subsidies directly linked to price will be added if the said subsidy is not provided by the Government. For example, a cafeteria in X Ltd (a corporate office) provides lunch at ₹ 120 per plate to the employees of the company. However, the vendor in the cafeteria receives an amount of ₹ 70 per plate in the form of subsidy from X Ltd for providing the food at a lower rate. Here, value of ₹ 70 will be added to the taxable value of ₹ 120 for the purpose of charging GST. Had this subsidy been provided by the Government to the company against mid day meals, such amount of ₹ 70 would not have been includible in the taxable value.

Discount is another area that needs special mention. The emphasis to tax treatment of discounts is visible in the repeated mention of discounts in section 15(3) where the value of supply will not include discount, provided:

- It is allowed before supply.
- It is allowed after supply, provided that it is established in agreement linked to specific supplies and corresponding credit is reversed by recipient.

It would be helpful to discuss the various kinds of discounts and the GST act implication of each, namely:

- 'In-bill' discounts – are those that are allowed exactly at the point of supply so as to reduce the published product price as a result of negotiations. Generally, 'in-bill' discounts are admissible as the reduction in arriving at the transaction value. However, abnormal discounts cast a shadow of doubt as regards price being the 'sole consideration'. To reiterate some of the points mentioned earlier, firstly, no one gives anything in exchange for nothing, secondly, one cannot give more than what they would get, thirdly, sale under distress circumstances does not mean sale is under duress and lastly, discount must always be related to the present supply and no others. When discount on an invoice is abnormal, inquiry is necessary regarding the circumstances for such an abnormal discount. Abnormality of discount refers to discount greater than

available margins. A supplier may be willing to give away all of his margin perhaps to clear away stocks and make room for new inventory. But, when the discount exceeds the margins and there are no distress circumstances, it appears highly suspect that the supplier is receiving something in non-monetary form from the customer. Although it seems strange that the 'in-bill' discount needs to be dissected and evaluated to such an extent but the need for that arises by the remarkable words used in the definition of consideration in section 2(31), particularly clause (b). On a quick perusal, it will now become palatable that the dissection and evaluation discussed about is very much warranted. It is so because hardly anything can escape this sweeping language 'in relation to, in response to or for the inducement of'. The supplier may be induced to offer more than his margins to conclude a supply and choose to designate it as 'discount'. The direction of the flow of supply is in the opposite direction of the flow of consideration, more on this a little later.

- 'Off-bill' discounts – are those that are allowed after supply through a credit note. Credit notes in the context of GST have been discussed in detail under section 34 which may be referred to identify whether in all cases of 'off-bill' discount, is credit note allowed to be issued. For such 'off-bill' discounts to qualify as the reduction from the transaction value adherence to the conditions specified in section 15(3) are sufficient. These conditions are very explicit and simple in their application. This simplicity is not to be equated with ease because these conditions specified are such that can cause great unease and result in many transactions where 'off-bill' discounts fail to satisfy these conditions. But when the conditions are satisfied, 'off bill' discounts can be reduced from the transaction value.
- Cash discounts – are those that are allowed to incentivize the customer for prompt payment. Merely because the policy of allowing cash discount is in existence before supply does not always make cash discounts eligible under section 15(3). In other words, the price at which a transaction of supply was negotiated and concluded is what is liable to GST and not the contingency linked to payment of the dues in respect of such supply. GST is not a tax on recovery of dues to word supplies but a tax on supply itself. Cash discounts therefore, are unlikely to satisfy the requirements of section 15(3) in most cases. As remarkable as this implication appears to be, cash discounts, when looked at very dispassionately, are more akin to bad debts than a proper reduction in the value of supply. Any resistance to accept this view needs to be supported with nothing less than the high standards laid down in section 15(3). Bad debts is not always failure to recover the value of supply. Bad debts can also be abstinence from enforcing recovery of the full value of supply. Bad debts is not the state of helplessness but the decision of prudence in the interest of continued relationship with customers, cost of pursuing recovery measures and the quantum of dues lying unrecovered. It is not suggested that all cases of cash discounts are not available to be reduced from the transaction value. But the circumstances under which cash discounts have been allowed requires inquiry into the circumstances leading to this cash discount.

- Quantity discounts – are those that are aimed at reducing the price of each supply on the condition that a certain quantity of stocks need to be exhausted within a specified duration of time. Here again, inquiry is required into the terms and conditions applicable to this quantity discount. Where the stock supplied by a manufacturer to a dealer are at a specified 'dealer price', which is applied in respect of supplies to all dealers along with additional discount linked to conditions – quantity and time – that is contingent at the time of supply by the manufacturer, this would be an eligible discount under section 15(3). But discounts allowed in an invoice in respect of supplies made earlier are not discounts because transaction value can be reduced by discount allowed in respect of the present supply and not in respect of any other supplies. This is because one of the conditions for allowance of the reduction in value is that the discount should be specifically linked to the original invoices against which the discount is to be given. Since, quantity discount is linked to time and volume and not against any specific invoice, the establishment of linking to the original invoices may be questionable.
- Special discounts – are those that are allowed by a supplier to incentivize aggressive marketing of inward supplies on special occasions or in special market conditions. In most cases, such incentives designated as special discounts are really acknowledgment of services of aggressive marketing and product promotion. The direction of flow of consideration is an indicator of the direction of receipt of supplies. In other words, the incentives flow from the manufacturer to the dealer, that are not related to the present supplies. In fact, it indicates an acknowledgment by the manufacturers of the services received from the dealer. The services so identified are from the dealer back to the manufacturers and this is a supply on its own. In fact the rate of tax of the services supplied by the dealer to the manufacturer needs to be classified independently of the classification applicable to the supplies by the manufacturer to the dealer. Although it is true that between a manufacturer and a dealer all transactions are closely related by the common thread of the dealership agreement, GST travels deeper into this relationship and picks out individual transactions of supply to apply the right rate of tax on each of them. Special discounts by their very nature appeared to be outside the scope of section 15(3).
- Discounts 'in-kind' – are those that are allowed in the form of holiday packages, gold coin, motor vehicle and other objects of high perceived incentive value. To begin with, these articles are rarely stocks in which the parties are dealing with. Further, these articles are incentives to the proprietor, director, marketing executive and other individuals and not the recipient of supplies in the normal course. Accordingly discounts in kind are not discounts satisfying the requirements of section 15(3). When a manufacturer pays money to a travel agency for a holiday package and issues the same to the individual-dealer identified, it is important to examine whether the payment by the manufacturer to the travel agent is a payment to discharge the obligation of the dealer (eligible for this incentive) or is it a direct inward supply from the travel agent to the manufacturer. If the travel agent issues the invoice in the name of the manufacturer, it is

an inward supply by the manufacturer. Where the said travel package is issued to the dealer, it is an outward supply under the paragraph 4(a), schedule II and accordingly liable to tax (at the respective rate of tax the along with restrictions on input tax credit, if any). If however, the invoice is issued by the travel agency in the name of the dealer but the payment alone moves from the manufacturer to the travel agency then, there is a supply of some services received by the manufacturer which is being paid by settling the bills of the travel agency. It is sufficient for the present if the issues involved in special discounts are appreciated. Reference may be had to a detailed discussion on supply to come back and identify existence of such invisible supplies lying embedded in seemingly ordinary transactions that are called discounts.

- Free stocks – are those that are similar to discounts ‘in-kind’ except that the articles given away are the items of inventory date with by the parties. In such a case, the stocks given away are taxable outward supply in exchange of non-monetary consideration flowing from the manufacturers to the dealer entitled to such free stocks. When the manufacturers gives away stocks for free to a dealer, it is clear that this is not the case of charity by the manufacturer towards the dealer but a prudent business decision by the manufacturer to allow the dealer to realize the following proceeds from sale of such free stocks and retain them as his incentive without having to make any payment to the manufacturer towards the cost of such free stocks. It is important to note that cost of such free stocks in the hands of the manufacturer would be far lower than the value of the incentive realized and retained by the dealer which is the selling price of these stocks. Here is a case where a manufacturer incurs a small cost and delivers a far greater perceived value to the dealer. In hindi, the word consideration has been referred as ‘Prathiphal’ which seems to convey the meaning on ‘quid pro quo’ more clearly. A further implication of giving away free stocks is that, in the hands of the manufacturer it is a taxable outward supply without the benefit of input tax credit to the dealer as no payment is made in respect of the supply. Having paid tax once on the outward supply by the manufacturer, there is a further taxable outward supply in the hands of the dealer when the free stocks are sold to customers. The tax inefficiency in transactions of issue of free stocks is evidently clear so that appropriate decisions may be made to revisit this entire policy.
- ‘Buy one-take two’ – are transactions where two units of stocks are supplied against payment of the price designated against only one of them. Under the method of transaction value-based assessment of tax under the GST law, each unit of stock is liable to determination of transaction value on its own merit. ‘buy one-take two’ is not the case where the two units of stocks are bundled together with a single price assigned to them but are individually priced with no differentiation in the quality of each of the units except that the present offer allows the customer to pay the published price of one and collect two units of the stock. The stock collected without making any payment could very well have been the one that was paid for and purchased or vice

versa. It merits to mention here that multiple units of a product may be bundled together with a single price published for them such as 4-bars of soap or pack-of-5 socks. Therefore, unless bundled together with preselected units of stock and a single price affixed, all other transactions of 'buy one-take two' are individually taxable – the paid unit at the price paid and the free unit at the price determined by the valuation rules.

- Nominal value supplies – is another form of discount or incentive where items of inventory are admitted to be a taxable outward supply but a nominal value is charged for such supply. Relying on the second proviso to rule 28, there appears to be a lot of confidence in continuing such nominal value supplies as a form of discount or incentive. The discussion under rule 28 may be referred to the implications of charging nominal value but for the present, it helps to recollect the discussions about regarding the requirement for every transaction to pass the test of 'sole consideration'. Charging a nominal value is an admission that the price is not the sole consideration and when price is not the sole consideration the transaction is dispatched into rule 27 for determination of the appropriate transaction value. As such, nominal value supplies are admittedly liable to tax but not at the nominal value. The value determinable as per Rule 27 should be taken for calculation of the liability of tax.
- Liquidated damages – Most of the contracts requires the performance by the suppliers within a given time limit. A delay beyond this time period may result in a loss being incurred to the recipient. To mitigate such losses and to ensure the performance of the contract within the time limit, liquidated damages may be collected. For instance, in a construction contract, the contractor undertakes to perform his service within 3 years and the delay beyond such period will result in deduction of the liquidated damages to the tune of 1% per month by the recipient. In such cases, it may prima facie seem that against the principal supply of construction services, a lower than agreed upon consideration is being received due to the delay in performance and such lower value should be offered for taxation. However, upon analysing the definition of supply under the GST law, it will result in a conclusion that there are actually two supplies which are taking place here. First is the principal supply of the construction service by the contractor for which the value was fixed as per the contract terms. Second supply is that which is provided by the recipient of the principal supply to the contractor in form of agreeing to the obligation to tolerate an act in terms of 5(e) of Schedule II against consideration in the form of deduction from total value of consideration. So, essentially there are two forms of supply for which the consideration are partially set off against each other through book entry usually and the balance monetary consideration only exchanges hands. This only provides one of the common models for settlement of liquidated damages. However, to determine the correct treatment of such charges, a threadbare analysis of the contractual rights and obligations along with the intent behind such contracts becomes an issue of utmost importance.

If and only if the transaction value cannot be determined as above, reference to CGST Rules related to valuation is permitted. Hence, recourse to the Valuation Rules is permitted only in the following circumstances:

- Supplies not covered by section 7(1)(a);
- Supplies covered by section 7(1)(a) but between related persons;
- Supplies covered by section 7(1)(a) and not adjusted for aspects provided by sub-section 2.

Government is free to notify tariff values in specific cases to determine the tax payable in such cases. This would prevail over the valuation provided for in sub-section 1. Valuation Rules are prescribed under Chapter IV of the Central Goods & Services Tax Rules, 2017 from Rule 27 to Rule 35.

(a) Consideration not wholly in money - Rule 27

This rule comes into effect when the condition that price is the sole consideration gets violated. It is important to consider the difference between 'free' and 'no consideration'. It is probably common to consider that these two are synonymous. At the outset, there can be no contract without consideration. Experts in Contract Law will see the gross illegality if one were to say that there is a contract that has no consideration in it. If the contract is valid, then there must exist a consideration though in non-monetary terms which is erroneously stated to be a contract having 'no consideration'. It is impermissible that a contract exists but lacks consideration. It is just impossible. If price is not the sole consideration, there should be consideration in some other form as per the contract. Normally, upon analysing the terms of the contract, consideration in all forms can be found out. Now, if there is a contract with non-monetary consideration, Rule 27 of the Central Goods and Services Tax Rules comes into operation. Although this rule states that it applies when 'consideration is not wholly in money', it applies even when the consideration is partly in money or wholly in non-monetary form. This rule provides that the value of supply "shall be" and not be "based on" or "guided by", so that mandatory nature of the prescription of this rule can be appreciated. Further, this rule comes into operation not only when the consideration paid is partly in money and partly in non-monetary form but also when the whole of the consideration is found to be in non-monetary form. Some of the transactions discussed earlier and found to be taxable supplies such as discounts, will rely on this rule to arrive at their value.

(b) "supply of goods or services or both of like kind and quality" means any other supply of goods or services or both made under similar circumstances that, in respect of the characteristics, quality, quantity, functional components, materials, and reputation of the goods or services or both first mentioned, is the same as, or closely or substantially resembles, that supply of goods or services or both.

The following transactions of supply under section 7 straightaway arrive at this rule for the determination of the transaction value as they failed to qualify for application of section 15(1),

namely:

- barter and exchange transactions
- transactions listed in schedule I
- transactions listed in schedule II but without consideration

The order of application of the methods prescribed under this rule cannot be deviated from merely because a later in the third is a more acceptable answer or is more easy to apply. The value of supply shall therefore be:

- (i) Open market value (OMV)– which is the ‘full value in money payable by an unrelated person as its sole consideration at the same time as the supply under inquiry. OMV is a new phrase but not too far from its scope and covered from its explanation. Transaction value is price of the supply under inquiry and open market value is the price of the same supply but without the circumstances that impairs the use of transaction value for quantification of tax. OMV is not comparable price to unrelated customer. The definition of OMV does not allow comparison of supplies in comparable circumstances. It only requires supply ‘at the same time’. So, OMV is not price in another ‘comparable’ supply at a close proximity in time. Bought-out goods given for non-monetary consideration has the purchase price itself as the OMV for outward supply. This provision does not provide the manner of adjustments to be made to overcome the effect of those disqualifying circumstances present but simply states that OMV ‘shall be’ the value of the supply. As such, this clause is not of much avail in addressing the deficiency which was the reason for arriving at the Rules as no resolution was possible in the section itself.

For example, in an offer of buy 1 get 1 free of shirts by a shop, the value charged is ₹ 2,000. In this situation, the free shirt will be subject to valuation under Rule 27. As the value of the chargeable shirt is available as ₹ 2,000, the open market value can be said to be taken as the valuation mechanism here. In that case, the free stock item may be subject to the same value as that of the chargeable stock item. So, the value for the purpose of charging GST will be considered as ₹ 4,000.

- (ii) Sum total of monetary consideration and ‘money-equivalent’ to consideration not in money – here two aspects are involved – one, to establish that OMV is not available (a task that will be discussed shortly) and two, to arrive at the money value of the non-monetary consideration. Having identified that OMV is not very specific to be able to clearly be determined, it becomes more acute to establish that OMV is not available before proceeding to clause (ii). Onus lies on the one who asserts – the taxable person would have admitted that the circumstances of section 15(1) are not fulfilled and warrants recourse to the Rules but having arrived at the rules, the onus remains with the taxable person to establish that OMV is not available. OMV is not comparable alternate price. Supplies to unrelated persons are always taking place although in different ‘commercial circumstances’ which is not provided in the definition of OMV. As

such, overcoming the first aspect – OMV not available – is a challenge which tax administration can be stubborn about. Then, arriving at money value of non-monetary consideration is not guided by requirement to use standards of Cost Accounting, etc. Rule of reasonableness is the only guide for arriving at the value which can be shot down by tactic of arbitrariness of the tax administration. Suitable guidance is much needed in this entire exercise.

For instance, an old antique art of work is sold against which consideration is partly in the form of money of ₹ 20,000 and partly in the form of a new furniture whose value known at the time of supply is ₹ 35,000. Then the value for the purpose of GST will be the monetary consideration combined with the equivalent money value of the new furniture i.e. ₹ 55,000.

- (iii) Value of supply of 'like kind and quality' – here again two aspects are involved – one, to establish that clause (a) and (b) are not determinable and two, to identify 'likeness' of kind and quality. This is a salutary method where there is much experience in Customs Valuation in successfully arriving at the comparable value. Subjectivity must be overcome which is possible by applying data that is reliably substantiated rather than arbitrary factors. The definition provides guidance on the manner of finding this 'likeness' for identifying whether the comparable are really comparable without being subject to any arbitrariness in tax compliance or tax administration.

As per the explanation of the term 'supply of goods or services or both of like kind and quality', the supply through which the comparison is taking place should be under similar circumstances in respect of the characteristics, quality, quantity, functional components, materials and reputation of goods or services or both and should be same or closely/substantially resemble the subject supply. So, all the factors should be taken into account and the supply which is closest in terms of these factors should only be taken for the purpose of valuation. The factor may not be exactly replicated in the supply being valued but should be substantially resembling the supply being used for comparison. This rule should not be applied if the circumstances are vastly different between the supply being valued and the one being used for comparison. For instance, the value of a product in New Delhi and that in Sikkim may be vastly different due to non similar circumstances. Further, it may be very difficult to compare the reputation and quality in respect of services as it involves subjectivity and arbitrariness. The nature of the services will depend on the facts and circumstances of each case.

Taking an example where this mechanism can be applied, a customised air conditioning unit whose open market value is not available is installed at an office wherein the consideration is paid in the form of money of ₹ 40,000 and an old air conditioning unit whose price is not available at the time of supply. A similar air conditioning unit in terms of characteristics, quality, quantity, functional components, materials and reputation etc. has been installed by the company at another client's premises for ₹ 60,000. Since, the value of goods of like kind and quality is available, the value of ₹ 60,000 will be taken under Rule 27.

- (iv) Sum total of monetary consideration and value determined by rule 30 or rule 31 in respect of consideration not in money – similar to the previous clause, the first of the two aspects – value is not determinable as above – is the one that presents the greatest difficulty. Expect that it is crude to import values from rule 30 or 31, the rest of this clause is simple in its application. Please note that rule 30 must be applied first and then rule 31, more on that in the discussion of those rules. Some illustrations are provided in rule 27 that may be referred for understanding its application.

Now, going back to the discussion on– valid contract having non-monetary consideration — it is important to understand some of the common instances when the supply is claimed to be of this nature, namely:

- Warranty supply of parts to end customer through a dealership – the parts are supplied ‘free’ to the end customer. At first, it is important to determine whether the parts replaced are actually covered by warranty in the supply contract or whether there is any replacement request entertained for out-of-warranty equipment for brand building exercise. Then, the warranty obligation lies only with the original equipment manufacturer (OEM) but the actual replacement is carried out at the dealership. When a warranty claim is made with the dealership by the end customer, the dealer seeks approval from OEM. Only after ‘in-warranty approval’ is received from OEM does the dealer replace the part. Now, the warranty replacement between OEM to end customer is not liable to GST not because it is free but because the price for the replacement is built into the price of the equipment originally supplied and therefore tax has already been paid by OEM. However, the dealer who replaces the part does not carry any role in the warranty fulfilment. In fact, the dealer ‘delivers’ the part to customer but ‘supplies’ it to OEM. Hence, there is another supply embedded here between dealer to OEM because dealer uses a tax-paid part from his inventory to replace it for the end customer. Alternatively, the OEM issues credit note to dealer for the part used in the warranty replacement. Reference may be had to Mohd. Ekram Khan’s decision of SC in 144 STC 542. As such, warranty involves two supplies and neither of which are free from tax. One is tax pre-paid and another is currently taxed though not involving end customer.
- Physician’s sample of drugs provided through sales representatives – these drugs are distributed by the physician during clinical consultation with patients. As such, the fee paid by patient to physician is one supply (whether taxable or exempt in GST) but the supply by pharmaceutical company to physician is another supply. To hold that cost of such free samples is included in the price of other units sold and therefore there is no requirement to again impose GST based on OMV on the samples, would go against the valuation methodology adopted in GST. In other words, GST law does not follow valuation based on ‘assessable value’ but follows valuation based on ‘transaction value’. If the cost or the value of the goods sold were to be the basis of computation of tax payable then the argument of inclusion of cost of samples may have been tenable. But that is not the case in GST and each supply must stand on its own merit to be

subjected to tax – if a price exists then tax would be computed on that price and if the price does not exist then tax would be computed on its OMV. If it is established that there is a non-monetary consideration flowing to the supplier then, samples will be liable to GST as determined by rule 27. This would be true not only of drugs but samples of any kind that are permanently given away. As regards physician's samples, there is raging debate that Courts are currently engaged in addressing due to the far reaching implications and no final outcome has yet been reached in this regard. This principle may be challenged if the facts considered to exist in the course of the about discussion were not to be in alignment in the facts of any other case so as to possibly receive a very different treatment in its valuation.

- Defaced samples of garments given to supplier by brand-holder – in comparison with physician's samples, defaced samples are those which are 'unfit for resale or end-use. Such kinds of samples are given in B2B transactions for helping suppliers to study the expected final product to prepare quotation for further orders. As these samples have been deliberately defaced and rendered unsuited for resale or end-use, there can be no argument that consideration flows from recipient of defaced samples back to brand-holder. Taking recourse to section 17(5)(h) does not satisfy the requirements of section 15 in the case of 'saleable' samples given away for non-monetary consideration. Reference may be had to the previous discussion on the concept of non-monetary consideration existing in a commercial transaction. Non-Availment of credit by a mistaken application of section 17(5)(h) will result in credit being given up along with the liability under section 15 continuing to exist where the samples given away are 'saleable' though not sold. Reference may be had to the detailed discussion on the circumstances requiring credit reversal in case of 'disposal' of samples that are 'unfit for sale'.
- Stocks issued to discharge CSR obligations – without repeating the concept of non-monetary consideration, it is sufficient to mention that consideration is recognized in India even if it flows from a third-party to a contract. Stocks issued without any flow of consideration from a recognized and qualifying charitable institution would continue to be a supply 'for consideration' *albeit* in non-monetary form where the obligation under Companies Act stands satisfied/fulfilled. This in itself is the consideration for the supply and GST becomes payable based on the OMV. Continuing further, stocks issued in excess of the CSR obligation limit would also be a taxable supply. A legal entity is incapable of feeling the emotion necessary to make voluntary contributions towards needy causes. What in fact takes place is that the management of the legal entity will feel the necessary emotion, draw the stocks from inventory and then issue it for such voluntary/charitable purposes. As such, the drawal of stocks from inventory by the management itself is a supply under paragraph 4(a), Schedule II and its subsequent issuance by the management does not alter the tax incidence. In fact, such charitable contributions by legal entity is disallowed as normal business expenditure for Income-

tax purposes and enjoys deduction under a different provision of tax laws, that is, Chapter VI-A.

- Impairment of assets accounted in books – as per AS 28 (Ind AS 36) where impairment provision is to be made or reversed every time the assessment is done, the implication in GST needs to be kept in mind as to whether there is a supply and whether there is any corresponding impact of credit denial under section 17(5)(h) in respect of these assets. The usage of the words 'written off' can trigger extreme consequences and therefore caution must be exercised in the accounting treatment, disclosure of such treatment and implications of such treatment or disclosure under GST on a case to case basis. Generally, GST should not be applicable on 'write down' in the value of an asset that is neither permanent nor irreversible but the nature of the accounting treatment extended to the inquiry undertaken in relation to impairment may yield a different result if it is regarded to be a 'write-off'. No definitive view is being expressed here on the GST liability of impairment.
- Leased car provided by employer disclosed in Form 12BA as perquisite – the reporting of perquisites admits a personal element involved in the enjoyment of the company car and the supply that is excluded in Schedule III is the service 'by' employee 'to' employer. But the present case is of supply of leased car 'by' employer 'to' employee which is not covered by Schedule III. By this admission in Form 12BA, GST becomes applicable but the valuation will not be as adopted in Rule 3 of Income-tax Rules but by GST Valuation Rules. It is important to examine the purpose of leasing a car by the employer and the purpose of permitting the employee to use the car. If it is for the advancement of the ends of the employer then it would not be a supply but if the ends of the employee are advanced, the conclusion would be very different. If the leased car provided to the employee is as per the terms of the employment agreement, then such charges of leased car becomes a part of cost to company in respect of that employee. In that case, a reasonable argument may emerge that the leased car is a consideration against the supply of services by the employee to employer which is excluded from the ambit of supply as per Schedule III. However, care should be taken to examine all attendant facts, contracted obligations, established practices and other information that indicate the primary purpose of such leasing arrangements.
- Free-issue-material provided by client to contractor – is admittedly not a supply in itself, but the question that arises is whether there is any consideration flowing from the client to the contractor vis-à-vis the free-issue-material (FIM). Care should be taken in drafting the contract whether the work was awarded for a full rate and then deductions are made towards FIM by reducing the running-account-bill of the contractor or whether the contract itself was awarded for the reduced rate. Reference may be had to NM Goel's decision 1989 AIR 285 (SC) in relation to sales tax and Bhayana Builders decision (2018) 51 GSTR 133 (SC) in the context of service tax. The development of collective thought of experts with regard to taxability of FIM depends on whether there is any consideration flowing from the contractor to the client for having issued the said

material or the material so issued is the object upon which the contractor is to carry out his supplies and fulfil his contracted obligations. If the contractor were merely required to account for the entire quantity of FIM received by him with complete liberty to apply the FIM for the client's project or on any other project, without any restrictions or embargo only then would it be a case of supply of the FIM itself. For the issuance of FIM to be regarded as a 'transfer', it must be absolute and unhindered to constitute a supply in and of itself. Reference may be had to the characteristics of each of the 8 forms of supply under section 7(1)(a) and examine if issuance of FIM comes within the grasp of any of the said forms of supply. Fabric given by a customer to a tailor is not a case of supply of fabric by the customer to the tailor and a supply back by the tailor of the finished garment. An air conditioner given by a customer to an electrician called upon for its installation, is not a case of supply of the air conditioner itself to the electrician. If the air conditioner were not given by the customer there would be nothing for the electrician to install. The electrician is not at liberty to install the air conditioner in any other premises but the premises of the customer. However, in the construction of a plant wherein the contractor was liable to supply the entire materials, if steel is supplied by the recipient which results in a reduction of the price of the contract, then such giving of steel will definitely be a supply by customer to contractor within GST. Further such supply of the works contract service by the contractor should include the value of steel within it. As such, experience and understanding of the fiction in the valuation provisions under the earlier laws – where composition rate of tax was applicable or abatement valuation method was followed – must not be allowed to percolate into GST. It goes without saying that legal fiction in any law does not travel beyond the purpose for which that fiction was coined. The law of GST entertains no such fiction when it comes to valuation of each taxable supply.

These illustrations do not cover all possible scenarios but lay down some pointers that need to be considered while determining the valuation and GST impact of various transactions.

(b) Supply between related persons (Rule 28)

A supply between related persons or between distinct persons (with same PAN) is *prima facie* not fulfilling the requirements of section 15 to admit the transaction value for quantification of GST. In such cases, the value of supply will be:

- (i) Open market value – please refer to previous discussion;

For example, a trader in computers gifts one of the laptops worth ₹ 50,000 to his relative during Diwali. Since the open market value of this is available, it needs to be taken for the purpose of charging GST.

- (ii) Value of supply of 'like kind and quality' – please refer to previous discussion;

For example, a Holding company provides a capital equipment whose open market value is not available to its subsidiary company which is not registered under GST. A similar capital equipment in terms of characteristics, quality, reputation etc. is available

in the market at ₹ 10,00,000. This value of ₹ 10,00,000 will be adopted for the purpose of valuation.

- (iii) Value determined by rule 30 or rule 31 – please refer to subsequent discussion.

The proviso to this rule is of significance where it is the recipient, who are entitled to full credit, the value declared in the invoice is deemed to be OMV. In other words, in a case of supply eligible by this rule – related parties or distinct persons – the supplier is entitled to unquestioned admittance of ‘any price’ that may be charged. This provision appears to accommodate internal preferences of the parties where the tax paid is revenue neutral. However, caution is advised in taking recourse of this proviso and charging a price lower than cost.

In the case of inter-branch supply of services, valuation of these supplies will involve additional tax due to costs such as salary, amortization, etc. which do not involve any input tax credit. For example, if a Head Office incurs certain entity-level expenses that are common to all registered taxable persons in other States, it is not permissible for the HO to retain the whole of these common credits due to the limitation in the language of section 16(1) – used by him in his business – although a portion of this credit may still be available. Previously, such HOs were registered as ISD under service tax but this may not be the case in GST. Please refer to discussion in section 20 for some analysis of these issues. Now, surely the HO is not ‘merely an office receiving invoice for services’ but is actually the ‘seat of management and control’ performing very significant services that are supplied to all branches. HOs ought not to continue as ISD but recognize the nature of the supply of services to all branches. And on this basis, apply these Rules for quantifying tax to be discharged. The proviso in this rule does not authorize payment of tax on cost because the value to be determined under this rule is OMV or else like-kind-and-quality or else rule 30 / 31 value. Hence, HO may be required to invoice for its services appropriately and not distribute credit as ISD. Valuation at nominal amount, appears to be permissible by second proviso to this rule. The eagerness to value stock transfers at nominal value misleads one to rely on the condition – recipient eligible for full input tax credit – appears to play culprit. It must be recalled that a transaction of stock transfers from one branch to another being defined to be a taxable supply under section 7(1)(c) read with schedule I deserves to be subjected to the rightful amount of tax based on the rightful value of this supply. This rule cannot undo what was set out to be achieved by the section. In order to read this second proviso harmoniously with the definition of supply, it appears to be appropriate to construe ‘the value declared in the invoice’ under the second proviso to be nothing short of the OMV of the stocks transferred between the branches inter se. This OMV could very well be the cost incurred by the supplier branch. But if the urge to apply nominal value to such supplies continues, by the words ‘value declared in the invoice’, the one declaring the value on the invoice cannot do so by affixing a nominal value which would be completely in disharmony between the rule and the section. A quick reference to rule 32 makes it clear that section 15 provides the boundaries within which every exercise of valuation must operate.

For example, an entity has four branches in Delhi, Mumbai, Kolkata and Bangalore. There is a head office of that entity in Hyderabad. The HO in Hyderabad recruits certain key management personnel for its branches. Here, it will be considered as if the manpower recruitment services are provided by the HO to its branches. For the valuation purposes, one needs to go through the hierarchy provided in Rule 28. As mentioned above, a nominal value for the purpose of billing should not be taken. There should be a reasonably justifiable method of valuation as explained above.

(c) Supply through agent (Rule 29)

Every supply involving an agent is not a taxable supply. As discussed in Chapter III, supply by Principal and Agent *inter se*, all though merely a channel to supply to the end customer, is treated as a supply in Schedule I where the goods are handled by the Agent or principal. Please note that this rule is applicable only in case of 'supply of goods' and not 'supply of services' or 'supply involving goods treated as supply of services'. When this rule is applicable, the value of supply will be:

- (i) open market value or 'at the option' of supplier 90% of the price charged for goods of 'like kind and quality' by the Agent– this rule provides for an ad hoc reduction of 10% from the price otherwise charged to accommodate the incentive or margin left for the Agent in pricing. Where margins are lower than 10%, this rule can cause great anguish. But, discarding the use of this clause is not permitted freely.
- (ii) value determined by rule 30 or rule 31 – please refer to subsequent discussion.

Transactions treated as supply by Schedule I of the CGST Act, which need to be subjected to tax requires a valuation mechanism. Principal and Agent do not *ipso facto* become related persons for rule 28 to be applicable to them.

Please note that agency cannot be inferred but must be express or implied. Agency may be understood as 'delegated authority' and 'detached consequences'. Within the scope of agency, the Principal will be obligated to third parties without any limit by actions of the Agent. As such, the authority to the Agent to act is delegated by the Principal and the Agent is not obliged to the consequences arising from his actions, provided they are within the scope of the agency. Undisclosed Principal still obligates the Principal because the lack of disclosure is to the third party and not that the Principal is unaware of the possible obligations accruing.

It is important to note that not all transactions between a Principal and Agent attract paragraph 3, schedule I. but it is only those transactions where the Agent 'handles' the goods of the Principal. Only when it is identified that it is a transaction of such nature, will the valuation under this rule become applicable. Further, it is to be considered that recourse to this rule is not an option because every transaction between Principal and agent are disqualified under section 15(1) and required to be examined with reference to these rules. Once having arrived at rule 29, there is only one method – price of supply of goods of like kind and quality – and no others. This rule applies only in respect of goods and not services.

There is a very interesting clue in a press release that permits advertisement agency to opt for either agency-model or resale-model as regards publishing of advertisements in media. Here, the press release appears to require an alternation in the contractual arrangement with the media (which may not be agreeable or not advisable), but it would be advantageous if, for limited purposes of GST, the agency were to apply agency-model or the resale-model.

Clarification on Value of Supply by a Del-Credere Agent (DCA) (Circular No. 73/47/2018-GST dated 05-11-2018)

DCA is a selling agent who is engaged by a principal to assist in supply of goods or services by contacting potential buyers on behalf of the principal. The factor that differentiates a DCA from other agents is that the DCA guarantees the payment to the supplier. Circular dated 05-11-2018 was issued to clarify on levy of GST on various types of DCA transactions with the principal.

In terms of the circular, a DCA would be an agent as per Schedule I of CGST Act if the invoice is raised by the principal to DCA and then by DCA to final customer. In such a scenario, DCA may advance credit to customer to enable him make payment to principal. For such credit, DCA charges interest as a consideration. In such a situation, there was a concern whether the interest charged by DCA to customer would be includible to compute GST in terms of Sec 15(2)(d), as the same was relatable to supply made by DCA to customer.

It is clarified that such interest is relatable to the supply of goods by DCA to Customer and was no more a separate supply of advancing credit. Such interest was to be included to the value of taxable supply of goods by DCA to its customer.

(d) Cost based value (Rule 30)

Where cost is used as a base for determining the value of supply and when any of the more specific methods prescribed are unavailable for specific reasons, this rule may be applied. It provides that the value will be 'cost plus 10%'. Please note that this rule applies to both goods and services supplied.

Every supply claimed to be free but involving non-monetary consideration faces the threat of tax being determined on this method. Cost of acquiring the product is the cost incurred by the person for bringing the production in the condition and location for the purpose of selling. While price paid to purchase goods that are given away for non-monetary consideration, the OMV is this purchase price but when it not a readily bought-out supply (goods or services), the cost construction method may need to be applied. Cost Accounting Standards may be relied upon to determine cost for purposes of this rule. CAS-4 enumerates various costs to be included in determining the cost of raw materials. As per the said standard, cost of material shall consists of cost of material, duties, taxes, freight inward, insurance and other expenses directly attributable to the procurement. Trade discount, rebate and similar items will be deducted in determining the cost of material. Input tax credit in any form will also be deducted. Thus cost of acquisition will include the cost of transportation, any local taxes, insurance, other expenditure like commission etc. on procurement of goods. However, cost of

determining provision of service is not that straightforward. In case of services, the major components are the cost of the employee and other administrative expenses,

Please refer to the few illustrations discussed in previous sections such as warranty replacement, physician's samples, etc. Tax administration may be kept at bay if valuation is not lower than 'cost plus 10%'. Although this method appears simple, it is important to note that only when it is established that the other more specific rule and the specific methods under those rules are unable to yield an acceptable value for the supply under inquiry. Only where the other methods of valuation cannot be applied, will this rule be available to apply. Where margins are not as high as 10%, suppliers may justifiably move to Rule 31 but by satisfying that this rule does not provide a reasonable value.

In respect of supply of services (also transactions involving goods treated as supply of services), the supplier is permitted to apply rule 31 instead of rule 30, if that were more favourable.

(e) Residual valuation (Rule 31)

Where value cannot be determined by any other method, this rule authorizes the use of 'reasonable means to arrive at the value. It is important to consider that these reasonable means must be commensurate with the principles of section 15. This rule provides some crucial guidance on the manner of application of all other rules – any valuation method applied that is contrary to 'principle of section 15' – may not be accepted.

(f) Lottery, betting, gambling and horse racing (Rule 31A)

The debate on the taxable value of services for betting, lottery, gambling and horse racing has been put to rest by introduction of Rule 31A to the CGST Rules vide notification no. 3/2018-Central Tax dated 23.2018. The said rule overrides all the other provisions relating to Valuation Rules. The use of the word 'shall be' implies that the value has to be necessarily determined as per the said rule. According to this rule, the valuation in respect of the following services shall be determined as follows:-

- (i) Lottery run by State Government** – Value of supply shall be 100/112 of the face value of ticket or the price as notified in the Official Gazette by the organising State; whichever is higher. – The phrase 'lottery run by State Government' is defined to mean a lottery not allowed to be sold in State other than the organising State. 'Organising State' has the meaning assigned in Rule 2(1)(f) of the Lotteries (Regulation) Rules, 2010 which is defined to mean any State Government which conducts the lottery either in its own territory or sells its tickets in the territory of any other State.
- (ii) Lottery authorized by State Government** - Value of supply shall be 100/128 of the face value of ticket or the price as notified in the Official Gazette by the organising State; whichever is higher. The phrase 'lottery authorized by State Government' has been defined to mean a lottery which is authorized to be sold in State(s) other than the organising State also.

It is relevant to note that the rate of GST on sale of lottery tickets run by State Government is 12% and the sale of lottery tickets which are authorized by State Government is liable to 28%. As stated in rule 31A, the face value of the lottery ticket shall be taken as inclusive of applicable taxes which is *pari-materia* with the provisions specified under rule 35.

- (iii) Betting, Gambling or Horse Racing – Actionable claim in the form of chance to win in betting, gambling or horse racing in a race club shall be 100% of the face value of the bet or the amount paid to totalisator. This implies that the value on which GST has to be paid will be the amount of bet placed or the amount paid to the totalisator instead of the commission or share of revenue of the race club.

It is interesting here to refer to schedule III which states that actionable claim other than lottery, betting and gambling would qualify as an activity or transaction which shall be treated neither as supply of goods nor supply of services. This means that transaction in lottery, betting and gambling would for the purpose of GST law, qualify as supply. The terms 'goods' under section 2(52) includes actionable claims. Services under section 2(102) is defined to exclude goods. Accordingly, the actionable claim in the form of chance to win betting, gambling and horse racing with reference to the above definitions will be goods and not services. Business under section 2(17) is defined to include the services provided by a race club by way of a totalisator or a licence to book maker in such club. The tax rate notifications issued for goods states that 'actionable claim in the form of chance to win in betting, gambling, or horse racing in race club' is liable to tax at the rate of 28% (refer entry No. 229 to schedule IV of Notification No. 1/2017 (Rate)). The rate notification issued for services also specifies that the gambling as an activity involving services and accordingly, liable to tax at 28% (refer entry No. 34(v) of Notification No. 11/2017 (Rate)).

It is also interesting to refer to the clarifications issued by TRU vide F. No. 354/107/2017-TRU dated 04.01.2018 wherein it is clarified that the actionable claim involving betting, gambling or horse racing would be a service. It is further clarified that the tax would be applicable at 28% on the total value of betting which exceeds the authority to tax since, only certain percentage of the total value of betting will be retained as commission in providing the services of betting / gambling and balance amount forms part of the prize money.

With the above ambiguities there may be some confusion whether to tax actionable claims as goods or services and the rate at which such supply should be taxed.

(g) Specific supplies (Rule 32)

Before commencement of the discussion on the provisions of Rule 32, it may be pertinent to emphasize here that the determination of valuation as per the mechanism specified is only an option available to the supplier. If the supplier feels that the valuation mechanism specified under the Rule 32 does not reflect the correct position or that the value adopted should be in

accordance with Section 15 and Rules 27 to 31, he may choose to ignore the said Rule 32. He may determine the value accordingly under Section 15 and Rules 27 to 31 as the case may be. Supplies which were previously under some form of abatement of value are found in this rule, namely:

- (i) supply of services involving sale/purchase of foreign currency, the value of supply will be:
 - (a) option (a) – difference between buying-selling rate and the reference rate published by RBI. Where reference rate is not available, 1% of gross Indian Rupee value of the transaction. And where the conversion is not into Indian Rupees, then 1% of the lesser of the Indian Rupee equivalent of each currency exchanged;
 - (b) option (b) – 1% of gross amount upto ₹1 lac, 1/2% after ₹1 lac upto ₹10 lacs and 1/10% after ₹10 lacs. This option (b) once exercised cannot be withdrawn during the financial year.
- (ii) supply of services by travel agent of booking of tickets for air-travel, the value of supply will be 5% of basic domestic fare or 10% of basic international fare. Please note that commission to the travel agent may flow from passenger or airline or any other person and the value determined here will be the tax for all the sources of commission. In case travel agents opt to pay tax on this abated value, a customer who is registered under GST law may have to forego input tax credit. Credit referred here is not merely the GST charged by the travel agent on the abated value. Travel agent will have eclipsed the GST charged by the airline on the ticket – 5% on economy ticket and 12% on any higher class ticket. For example, on a ticket value of ₹1 lac, GST paid by airline could be as high as ₹12,000 but the travel agent would issue an invoice for ₹1 lac + GST of ₹500. Registered customer would not be willing to forego this credit of ₹12,000. As mentioned by someone, a credit-hungry registered customer would drive the travel agent to reverse his supply model – airline to invoice the (registered) customer directly to pass on credit and agent to invoice service fee to airline.
- (iii) supply of services in relation to life insurance, the value of supply will be gross premium reduced by investment allocation, in the case of single premium policy will be 10% of premium and in all other cases will be 25% of first year's premium and 12.5% for other year's premia. This rule will not apply to premium related to coverage for risk-of-life.
- (iv) supply of services of person dealing in second-hand goods, the value of supply will be difference between purchase price and selling price. Please note 'second-hand goods' refers to goods used or otherwise employed in some process without causing any change in their nature. Used goods and not the same as pre-owned goods which need not have been put to use. For example, a motor car where mark of registration has been assigned by RTO, even if left unused for long time will not be able to satisfy that it has not been used. And similarly, the odometer reading showing '0 kms' but duly registered by RTO will not override the conclusion that it is used. Please note that most

appropriate tests for identifying whether the goods have been used or not may be examined. Also, this rule does not apply only to 'supply of second-hand goods' but to supply of services of person dealing in second-hand goods. In other words, disposal of leased car will also come within the operation of this rule

Intra-State supplies of second hand goods, by an unregistered supplier to a registered person, dealing in buying and selling of second hand goods and who pays the central tax and compensation cess on the value of outward supply of such second hand goods as determined under Rule 32(5) of Central goods and Services tax Rules, 2017, is exempted. This has been done to avoid double taxation on the outward supplies made by such registered person, since such person operating under the margin scheme cannot avail input tax credit on the purchase of second hand goods. (NN 10/ 2017-Central Tax (Rate) dated 28-Jun-17 and NN 04/ 2017-Compensation cess (Rate) dated 20-Jul-17)

It is important to note that the registered taxable person disposing off used-goods would not be able to avoid payment of tax on this outward supply. Facility under this 'margin method' is available only when the outward supply involving sale of used-goods is by a unregistered person to a registered taxable person dealing in used-goods. In the case of used-cars, the levy of tax on outward supply has completely taken the sheen off used-car business because registered sellers cannot avail this margin-method coupled with the visibly high rates of GST plus Cess applicable. However, the Government vide notification no. 8/2018-Central Tax (Rate) dated 25.01.2018 has reduced the rate of GST to 18% and 12% on the sale of old and used motor vehicles. Further, the Cess payable on sale of old and used motor vehicle has also been exempted vide notification no. 1/2018-Compensation Cess(Rate) dated 25.01.2018. However, the major change as per the said notification was the valuation mechanism under GST. The said valuation was stated to be the margin involved i.e. the difference between the selling and purchase price. If the selling price is greater than the purchase price, then this amount should be ignored for the purpose of GST. However, where the selling price is lower than the purchase price, only the differential margin will be taxable. In case of sale by a registered person, it has been stated that the value that needs to be taken in lieu of the purchase price will be the depreciated value of goods on the date of supply. So, the taxability arises in respect of the margin if the selling price is higher than the depreciated value of the motor vehicle,

Illustration: Mr. X, a registered person in GST had purchased a motor car on 1st June, 2016 for ₹ 10,00,000. The said car was sold on 25th February 2018 by him for:

- a) ₹ 9,00,000
- b) ₹ 7,00,000

Determine the valuation under GST

Ans: The depreciated value of the car as on 1st April 2017 is ₹ 10,00,000 – 15%*10,00,000 = ₹ 8,50,000. If the sale value of the car is Rs,9,00,000, ₹ 50,000 will be the value for charging GST. If the car is sold at ₹ 7,00,000, the margin will be negative and hence it should be ignored.

Proviso to Rule 32(5) speaks about the repossession of goods in case of default by an unregistered borrower. In this scenario, the purchase price for the calculation of margin will be the purchase price of such goods by the defaulter. However, such purchase price will be subject to reduction of 5% every quarter or part thereof for the period between the date of purchase and the date of disposal. Illustration: Mr. X took a car loan of ₹ 3,00,000 from ABC Bank Ltd. on 1st September 2017 which was entirely used for the purchase of car worth the same amount. Mr. X defaults on the loan balance and thereby his car is repossessed by the bank on 1st March 2018. This car is sold on 30th March 2018 by the bank for ₹ 2,50,000. Determine the valuation under GST.

Answer: The purchase value to be taken will be the purchase price in the hands of the borrower – 5% per quarter or part thereof (September – March) i.e. 3,00,000 – (5%*3*300,000) = ₹ 2,55,000. As the sale value of the car is below ₹ 2,55,000, the margin will be ignored for the charging of GST

- (v) supply of voucher, the value will be the redemption value of the voucher. Please note voucher includes coupon, stamp, token, etc. Please refer to the discussion on vouchers under section 13 for the various forms that voucher can take including digital vouchers to which this rule will apply. Also, please note the those instruments that are approved by RBI and included in the definition of 'money' under the expression “.....or any other instrument approved by RBI when used as a consideration to settle an obligation.....” should not be treated as vouchers merely because they are popularly referred as 'vouchers'. All vouchers are not vouchers attracting this rule. Reference may be had to the discussion under section 12(4)/13(4) to identify instruments that 'are' or 'are not' vouchers.

Illustration: Mr. X had purchased a voucher for ₹ 200 which was redeemable against purchase of a wallet worth ₹ 500 from Shopper's stop. Here, the valuation that should be taken here is the redemption value of ₹ 500 in respect of the voucher and not the purchase value of ₹ 200.

- (vi) supply of services between distinct persons, that are notified by Government and where input tax credit is availed will be Nil. Please note that the implications of denial of credit u/s 17(2) in case of supply being exempt will be attracted in these cases. Care should be taken to identify that the notification to be issued in this regard are 'distinct persons' and supplies *inter se* when notified will have a deemed value of Nil. No notification has been issued as yet, in this regard. But it is expected that branches of banks may be notified to avail this facility where credit is fully available to the recipient-branch and even if 50% credit facility is availed by the bank, it is applicable only at the supplier-branch under section 17(4). And this expectation is borrowed from benefit to suppliers by second proviso to rule 46.

(h) Service of pure agent (Rule 33)

Agency supplies are different from 'pure agent' in relation to valuation. This rule applies only to supply of services. It provides for the exclusion from valuation of any supply of certain costs and expenses if and only if the following tests are satisfied:

- (i) the supplier acts as a pure agent of the recipient of the supply, when he makes the payment to the third party on authorisation by such recipient; the payment made by the pure agent on behalf of the recipient of supply has been separately indicated in the invoice issued by the pure agent to the recipient of service; and
- (ii) the supplies procured by the pure agent from the third party as a pure agent of recipient of supply are in addition to the services he supplies on his own account. *Explanation.-* For the purposes of this rule, the expression "pure agent" means a person who-
 - (a) enters into a contractual agreement with the recipient of supply to act as his pure agent to incur expenditure or costs in the course of supply of goods or services or both;
 - (b) neither intends to hold nor holds any title to the goods or services or both so procured or supplied as pure agent of the recipient of supply;
 - (c) does not use for his own interest such goods or services so procured; and
 - (d) receives only the actual amount incurred to procure such goods or services in addition to the amount received for supply he provides on his own account.

Illustrations

a) Corporate services firm A is engaged to handle the legal work pertaining to the incorporation of Company B. Other than its service fees, A also recovers from B, registration fee and approval fee for the name of the company paid to the Registrar of Companies. The fees charged by the Registrar of Companies for the registration and approval of the name are compulsorily levied on B. A is merely acting as a pure agent in the payment of those fees. Therefore, A's recovery of such expenses is a disbursement and not part of the value of supply made by A to B.

- (a) Ticket in railways is booked by a travel agent on behalf of the customer and the charges for such ticket are recovered by the agent along with the commission by showing them separately
- (b) Customs duty, dock dues, transportation, port clearance charges etc. are paid by the customs broker on behalf of the importer and are recovered along with his commission from the importer
- (c) Advertisement charges to the newspaper are paid by Advertising agency on behalf of the customer and are recovered separately along with commission
- (d) In an ex-factory delivery contract, if the transportation charges are paid by the supplier on behalf of the recipient and are recovered separately from the recipient along with the price of the goods

To establish that the conditions of pure agent are getting satisfied, it is recommended that there should be a written contract between the supplier and the recipient. The clauses of the agreement should clearly point to compliance with all the conditions as discussed above with regard to pure agent. This will act as the most reasonable defense if any questions are raised by the Department later on. However, even if the contract is not in writing, it can be established by other available evidence that the conditions of pure agent are satisfied. However, any contract in writing may be considered as more persuasive in nature.

Further, in order to claim any amount as a deduction in the form of a pure agent, the dealer will have to demonstrate with substantial evidence that the liability to incur the cost was on the recipient and that the dealer has incurred such cost merely for convenience sake. Further, the dealer has to ensure that the invoice/ bill of supply/ receipt has been received in the name of the recipient, who is the ultimate beneficiary.

(i) Exchange rate to be used (Rule 34)

Transactions undertaken in foreign currency must be translated into Indian Rupees. The rate of exchange for the determination of the value of taxable goods shall be the applicable rate of exchange as notified by the Board under section 14 of the Customs Act, 1962 and for the determination of the value of taxable services shall be the applicable rate of exchange determined as per the generally accepted accounting principles for the date of time of supply in respect of such supply in terms of section 12 or, as the case may be, section 13 of the Act.

Illustrations on Section 15 read with Central Goods and Service Tax Rules:

Q1. Mrs. Jaya purchases a Samsung television set costing ₹ 85,000 from Giriyas, in exchange of her existing TV set. After an hour of bargaining, the shop manager agrees to accept ₹78,000 instead of his quote of ₹81,000, as he would still be in a profitable position (the old TV can be sold for ₹8,000).

Ans. Where the price is not the sole consideration for the supply, the 'open market value' would be the value of the supply. Therefore, ₹ 85,000 would be the value of the supply.
[Section 15(4) r/w Rule 27(a) of Central Goods and Service Tax Rules]

Q2. Mr. Mohan located in Manipal purchases 10,000 Hero ink pens worth ₹4,00,000 from Lekhana Wholesalers located in Bhopal. Mr. Mohan's wife is an employee in Lekhana Wholesalers. The price of each Hero pen in the open market is ₹52. The supplier additionally charges ₹5,000 for delivering the goods to the recipient's place of business.

Ans. Mr. Mohan and Lekhana Wholesalers would not be treated as related persons merely because the spouse of the recipient is an employee of the supplier, although such spouse and the supplier would be treated as related persons. Therefore, the transaction value will be accepted as the value of the supply. The transaction value includes incidental expenses incurred by the supplier in respect of the supply up to the time of delivery of goods to the recipient. This means, the transaction value will be: ₹4,05,000 (i.e., 4,00,000 + 5,000).

[Section 15(1) r/w Section 15(2)]

Q3. Sriram Textiles is a registered person in Hyderabad. A particular variety of clothing has been categorised as non-moving stock, costing ₹5,00,000. None of the customers were willing to buy these clothes in spite of giving big discounts on them, for the reason that the design was too experimental. After months, Sriram Textiles was able to sell this stock on an online website to another retailer located in Meghalaya for ₹2,50,000, on the condition that the retailer would put up a poster of Sriram Textiles in all their retail outlets in the State.

Ans. The supplier and recipient are not related persons. Although a condition is imposed on the recipient on effecting the sale, such a condition has no bearing on the contract price. This is a case of distress sale, and in such a case, it cannot be said that the supply is lacking 'sole consideration'. Therefore, the price of ₹2,50,000 will be accepted as value of supply.

[Section 15(4) r/w Rule 27(d) r/w Rule 31 of Central Goods and Services Tax Rules]

Q4. Rajguru Industries stock transfers 1,00,000 units (costing ₹10,00,000) requiring further processing before sale, from Bijapur in Karnataka to its Nagpur branch in Maharashtra. The Nagpur branch, apart from processing units of its own, engages in processing of similar units by other persons who supply the same variety of goods, and thereafter sells these processed goods to wholesalers. There are no other factories in the neighbouring area which are engaged in the same business as that of its Nagpur unit. Goods of the same kind and quality are supplied in lots of 1,00,000 units each time, by another manufacturer located in Nagpur. The price of such goods is ₹9,70,000.

Ans. In case of transfer of goods between two registered units of the same person (having the same PAN), the transaction will be treated as a supply even if the transfer is made without consideration, as such persons will be treated as 'distinct persons' under the GST law. The value of the supply would be the open market value of such supply. If this value cannot be determined, the value shall be the value of supply of goods of like kind and quality. In this case, although goods of like kind and quality are available, the same may not be accepted as the 'like goods' in this case would be less expensive given that the transportation costs would be lower. Therefore, the value of the supply would be taken at 110% of the cost, i.e., ₹ 11,00,000 (i.e., 110% * 10,00,000).

However, if the Nagpur branch is eligible for full input tax credit, the value declared in the invoice will be deemed to be the open market value of the goods in terms of 2nd proviso of Rule 28.

[Section 15(4) r/w Rule 28(b) & (c) r/w Rule 30 of Central Goods and Services Tax Rules]

Q5. M/s. Monalisa Painters owned by Vasudev is popularly known for painting the interiors of banquet halls. M/s. Starry Night Painters (also owned by Vasudev) is engaged in painting machinery equipment. A factory contracts M/s. Monalisa Painters for painting its machinery to keep it free from corrosion, for a fee of ₹1,50,000. M/s. Monalisa Painters sub-contracts the work to M/s. Starry Night Painters for ₹1,00,000, and ensures supervision of the work performed by them. Generally, M/s. Starry Night

Painters charges a fixed sum of ₹1,000 per hour to its clients; it spends 120 hours on this project.

Ans.: Since M/s. Monalisa Painters and M/s. Starry Night Painters are controlled by Mr. Vasudev, the two businesses will be treated as related persons. Therefore, ₹1,00,000 being the sub-contract price will not be accepted as transaction value. The value of the service would be the open market value being ₹ 1,20,000 (i.e., ₹ 1,000 per hour * 120 hours) *.

Note: This view is based on the grounds that there are no comparables to this supply.

However, if M/s. Starry Nights is eligible for full input tax credit, the value declared in the invoice shall be deemed to be the open market value of services i.e. ₹ 1,00,000/-

[Section 15(4) r/w Rule 28(a) of Central Goods and Services Tax Rules]

Q6. Prestige Appliances Ltd. (Bangalore) has 10 agents located across the State of Karnataka (except Bangalore). The stock of chimneys is dispatched on Just-In-Time basis from Prestige Appliances Ltd. to the locations of the agents, based on receipt of orders from various dealers, on a weekly basis. Prestige Appliances Ltd. is also engaged in the wholesale supply of chimneys in Bangalore. An agent places an order for dispatch of 30 chimneys on 22-Sep-2017. Prestige had sold 30 chimneys to a retailer in Bangalore on 18-Sep-2017 for ₹ 2,80,000. The agent effects the sale of the 30 units to a dealer who would affect the sales on MRP basis (i.e., @ ₹10,000/unit).

Ans.: The law deems the supplies between the principal and agent to be supplies for the purpose of GST. Therefore, the transfer of goods by the principal (Prestige) to its agent for him to effect sales on behalf of the principal would be deemed to be a supply although made without consideration. The value would be either the open market value, or 90% of the price charged by the recipient of the intended supply to its customers, at the option of the supplier. Thus, the value of the supply by Prestige to its agent would be either ₹ 2,80,000, or 2,70,000 (i.e., 90%*10,000 * 30), based on the option chosen by Prestige.

[Section 15(5) r/w Rule 29(a) of Central Goods and Services Tax Rules]

Q7. Mr. & Mrs. Mehta purchase 10 gift vouchers for ₹ 500 each from Crossword, and 5 vouchers from Four Fountains Spa costing ₹ 1,000 each, and gives them as return gifts to children and their parents for their son's birthday party. The vouchers from Four Fountains Spa had a special offer for couples – services for both persons at the price chargeable to one.

Ans. The value of the supply would be the money value of the goods redeemable against the voucher. Thus, in case of vouchers from Crossword, the value would be ₹ 5,000 (i.e., ₹500 * 10) and the value of vouchers in case of Four Fountains Spa would be ₹ 10,000 (i.e., ₹ 1,000 * 2 * 5).

[Section 15(5) r/w Rule 32(6) of Central Goods and Services Tax Rules]

Q8. In a rent of company accommodation, the rent received by the landlord is ₹ 30,000 per month. As per the said contract, the building maintenance to the tune of ₹ 3,000 per

month is required to be paid by the landlord. In the month of April 2018, the tenant directly pays the building maintenance to the residential society and deducts the said amount from the total consideration of ₹ 30,000 and ₹ 27,000 to the landlord. Further, the tenant discharge municipal taxes of ₹ 2,000 in April 2018. Find the taxable value in the month of April 2018?

Ans. ₹ 3,000 represents the amount liable to be discharged by the landlord which has been paid by the tenant. So, ₹ 3,000 will be added to the actual price paid or payable of ₹ 27,000 for the purpose of valuation. ₹ 2,000 will also be added to the taxable value as it is in the form of taxes, duties, cesses, fees and charges levied under the law. So, the total taxable value will be ₹ 32,000.

[Section 15(2)(a) and Section 15(2)(b)]

15.3. Comparative Review

Valuation Rules in Customs, Central Excise and Service Tax have been tested for applicability in various circumstances. All that experience and judicial interpretation may be brought to provide a good understanding of the words used in these Rules and the purpose for such usage. They are:

- Customs Valuation (Determination of Price of Imported Goods) Rules, 2007
- Customs Valuation (Determination of Price of Export Goods) Rules, 2007
- Central Excise Valuation (Determination of Price of Excisable Goods) Rules, 2000
- Central Excise (Determination of Retail Sale Price of Excisable Goods) Rules, 2008
- Service Tax (Determination of Value) Rules, 2006

15.4. Issues and concerns

1. There appears to be concerns over the taxability of actionable claims in form of betting, gambling and horse race as goods or services. The definition of goods specifically states that the actionable claims would qualify as goods for the purpose of GST law. When that being the case, seems appropriate to conclude that the actionable claim as goods and accordingly, the applicable rate of tax should be ascertained. This is based on the understanding that the notifications cannot overrule what is specified under the law.
2. A taxable person should be cautious in case of supply of services where the consideration is in kind by way of receipt of other services. In such cases, it may appear that the services are supplied without consideration. However, the it could result in barter which would qualify as barter. For illustration, we may refer to the recent advance ruling wherein the Kerala Authority of Advance Ruling has pronounced that the canteen services provided to employees would amount to supply and accordingly, canteen recoveries from the employees would be subject to GST. Such caution should be exercised since the payment of GST on the subsidized recovery would be incorrect. It is a supply of service by employer in exchange of employment services by employee and

since, the employer and employee are termed as related parties, the valuation of such supplies should be in terms of rule 28. In other words, the employer should remit the tax at open market value. In this backdrop, a taxable person should exercise extra caution to ascertain the value of taxable supply of services.

3. The common expenses incurred by a taxable person in relation to procurement of services used by the branches located in another States, the allocation of such expenses to respective branches may qualify as supply of services. There appears to be an ambiguity on ascertaining the time of supply – whether, at the end of each month such taxable person should arrive at the cost to be allocated respective branches and remit the tax accordingly or shall arrive at the cost to be allocated at the end of the year and remit the tax on the expenses allocated to branch for the whole year.
4. The discount after effecting the taxable supplies should be issued by credit notes. Section 34(2) states that the discounts should be issued before the end of September following the end of the financial year or the date of furnishing the annual return. This necessarily means that discount can be issued to the recipient after the supplies are effected but not after the lapse of time period specified under section 34(2).
5. Every transaction seems to be covered by 'consideration'. It is important to carefully understand benefits, rewards and gratuitous contributions that do not amount to consideration under Contract law (see section 25 and 70 of Contract Act).

Chapter 6

Input Tax Credit

Sections	Rules
16. Eligibility and conditions for taking input tax credit.	36. Documentary requirements and conditions for claiming input tax credit
17. Apportionment of credit and blocked credits.	37. Reversal of input tax credit in the case of non-payment of consideration
18. Availability of credit in special circumstances.	38. Claim of credit by a banking company or a financial institution
19. Taking input tax credit in respect of inputs and capital goods sent for job work.	39. Procedure for distribution of input tax credit by Input Service Distributor
20. Manner of distribution of credit by Input Service Distributor.	40. Manner of claiming credit in special circumstances
21. Manner of recovery of credit distributed in excess	41. Transfer of credit on sale, merger, amalgamation, lease or transfer of a business
	42. Manner of determination of input tax credit in respect of inputs or input services and reversal thereof
	43. Manner of determination of input tax credit in respect of capital goods and reversal thereof in certain cases
	44. Manner of reversal of credit under special circumstances
	44A. Manner of reversal of credit of Additional duty of Customs in respect of Gold dore bar
	45. Conditions and restrictions in respect of inputs and capital goods sent to the job worker

Statutory Provisions- Effective from 1st July, 2017 to 31st January, 2019**16. Eligibility and conditions for taking input tax credit**

- (1) *Every registered person shall, subject to such conditions and restrictions as may be prescribed and in the manner specified in section 49, be entitled to take credit of input tax charged on any supply of goods or services or both to him which are used or intended to be used in the course or furtherance of his business and the said amount shall be credited to the electronic credit ledger of such person.*
- (2) *Notwithstanding anything contained in this section, no registered person shall be entitled to the credit of any input tax in respect of any supply of goods or services or both to him unless, -*
- (a) *he is in possession of a tax invoice or debit note issued by a supplier registered under this Act, or such other tax paying documents as may be prescribed;*
- (b) *he has received the goods or services or both*
Explanation.—For the purposes of this clause, it shall be deemed that the registered person has received the goods where the goods are delivered by the supplier to a recipient or any other person on the direction of such registered person, whether acting as an agent or otherwise, before or during movement of goods, either by way of transfer of documents of title to goods or otherwise;
- (c) *subject to the provisions of section 41, the tax charged in respect of such supply has been actually paid to the Government, either in cash or through utilization of input tax credit admissible in respect of the said supply; and*
- (d) *he has furnished the return under section 39:*
Provided that where the goods against an invoice are received in lots or instalments, the registered person shall be entitled to take credit upon receipt of the last lot or instalment:
Provided further that where a recipient fails to pay to the supplier of goods or services or both, other than the supplies on which tax is payable on reverse charge basis, the amount towards the value of supply along with tax payable thereon within a period of one hundred and eighty days from the date of issue of invoice by the supplier, an amount equal to the input tax credit availed by the recipient shall be added to his output tax liability, along with interest thereon, in such manner as may be prescribed:
Provided also that the recipient shall be entitled to avail of the credit of input tax on payment made by him of the amount towards the value of supply of goods or services or both along with tax payable thereon.
- (3) *Where the registered person has claimed depreciation on the tax component of the cost of capital goods and plant and machinery under the provisions of the Income Tax Act, 1961, the input tax credit on the said tax component shall not be allowed.*

- (4) *A registered person shall not be entitled to take input tax credit in respect of any invoice or debit note for supply of goods or services or both after the due date of furnishing of the return under section 39 for the month of September following the end of financial year to which such invoice or invoice relating to such debit note pertains or furnishing of the relevant annual return, whichever is earlier.*

Statutory Provisions- Effective from 1st February 2019 vide The Central Goods & Services Tax Amendment Act,2018

16. Eligibility and conditions for taking input tax credit

- (2) *Every registered person shall, subject to such conditions and restrictions as may be prescribed and in the manner specified in section 49, be entitled to take credit of input tax charged on any supply of goods or services or both to him which are used or intended to be used in the course or furtherance of his business and the said amount shall be credited to the electronic credit ledger of such person.*
- (2) *Notwithstanding anything contained in this section, no registered person shall be entitled to the credit of any input tax in respect of any supply of goods or services or both to him unless, -*
- (a) *he is in possession of a tax invoice or debit note issued by a supplier registered under this Act, or such other tax paying documents as may be prescribed;*
- (b) *he has received the goods or services or both*
- Explanation—For the purposes of this clause, it shall be deemed that the registered person has received the goods or, as the case may be, services—*
- (i) *where the goods are delivered by the supplier to a recipient or any other person on the direction of such registered person, whether acting as an agent or otherwise, before or during movement of goods, either by way of transfer of documents of title to goods or otherwise;*
- (ii) *where the services are provided by the supplier to any person on the direction of and on account of such registered person*
- (c) *subject to the provisions of section 41, the tax charged in respect of such supply has been actually paid to the Government, either in cash or through utilization of input tax credit admissible in respect of the said supply; and*
- (d) *he has furnished the return under section 39:*
- Provided that where the goods against an invoice are received in lots or instalments, the registered person shall be entitled to take credit upon receipt of the last lot or instalment:*
- Provided further that where a recipient fails to pay to the supplier of goods or services or both, other than the supplies on which tax is payable on reverse charge*

basis, the amount towards the value of supply along with tax payable thereon within a period of one hundred and eighty days from the date of issue of invoice by the supplier, an amount equal to the input tax credit availed by the recipient shall be added to his output tax liability, along with interest thereon, in such manner as may be prescribed:

Provided also that the recipient shall be entitled to avail of the credit of input tax on payment made by him of the amount towards the value of supply of goods or services or both along with tax payable thereon.

- (3) *Where the registered person has claimed depreciation on the tax component of the cost of capital goods and plant and machinery under the provisions of the Income Tax Act, 1961, the input tax credit on the said tax component shall not be allowed.*
- (4) *A registered person shall not be entitled to take input tax credit in respect of any invoice or debit note for supply of goods or services or both after the due date of furnishing of the return under section 39 for the month of September following the end of financial year to which such invoice or invoice relating to such debit note pertains or furnishing of the relevant annual return, whichever is earlier.*

Extract of the CGST Rules, 2017

36. Documentary requirements and conditions for claiming input tax credit.

- 1) *The input tax credit shall be availed by a registered person, including the Input Service Distributor, on the basis of any of the following documents, namely,-*
 - (a) *an invoice issued by the supplier of goods or services or both in accordance with the provisions of section 31;*
 - (b) *an invoice issued in accordance with the provisions of clause (f) of sub-section (3) of section 31, subject to the payment of tax;*
 - (c) *a debit note issued by a supplier in accordance with the provisions of section 34;*
 - (d) *a bill of entry or any similar document prescribed under the Customs Act, 1962 or rules made thereunder for the assessment of integrated tax on imports;*
 - (e) *an Input Service Distributor invoice or Input Service Distributor credit note or any document issued by an Input Service Distributor in accordance with the provisions of sub-rule (1) of rule 54.*
- 2) *Input tax credit shall be availed by a registered person only if all the applicable particulars as specified in the provisions of Chapter VI are contained in the said document, and the relevant information, as contained in the said document, is furnished in FORMGSTR-2 by such person.*

Provided that if the said document does not contain all the specified particulars but contains the details of the amount of tax charged, description of goods or services, total value of supply of goods or services or both, GSTIN of the supplier and recipient and place of supply in case of inter-State supply, input tax credit may be availed by such registered person.¹

- 3) *No input tax credit shall be availed by a registered person in respect of any tax that has been paid in pursuance of any order where any demand has been confirmed on account of any fraud, willful misstatement or suppression of facts.*

37. Reversal of input tax credit in case of non-payment of consideration.

- 1) *A registered person, who has availed of input tax credit on any inward supply of goods or services or both, but fails to pay to the supplier thereof, the value of such supply along with the tax payable thereon, within the time limit specified in the second proviso to subsection(2) of section 16, shall furnish the details of such supply, the amount of value not paid and the amount of input tax credit availed of proportionate to such amount not paid to the supplier in FORM GSTR-2 for the month immediately following the period of one hundred and eighty days from the date of the issue of the invoice.*

Provided that the value of supplies made without consideration as specified in Schedule I of the said Act shall be deemed to have been paid for the purposes of the second proviso to sub-section (2) of section 16.

Provided further that the value of supplies on account of any amount added in accordance with the provisions of clause (b) of sub-section (2) of section 15 shall be deemed to have been paid for the purposes of the second proviso to sub-section (2) of section 16²

- 2) *The amount of input tax credit referred to in sub-rule (1) shall be added to the output tax liability of the registered person for the month in which the details are furnished.*
- 3) *The registered person shall be liable to pay interest at the rate notified under sub-section (1) of section 50 for the period starting from the date of availing credit on such supplies till the date when the amount added to the output tax liability, as mentioned in sub-rule (2), is paid.*
- 4) *The time limit specified in sub-section (4) of section 16 shall not apply to a claim for re-availing of any credit, in accordance with the provisions of the Act or the provisions of this Chapter, that had been reversed earlier.*

¹ Inserted by the Central Goods and Services Tax (Eight Amendment) Rules, 2018 w.e.f. 04.09.2018.

² Inserted by the Central Goods and Service Tax (Fifth Amendment), Rules, 2018 w.e.f. 13.06.2018.

Relevant circulars, notifications, clarifications issued by Government

1. Chapter Nineteen of the compilation of the GST Flyers as issued by the CBIC on 'Input Tax Credit Mechanism in GST'

Related Provisions of the Statute

Section or Rule	Description
Section 17	Apportionment of credit and blocked credits
Section 31	Tax invoice.
Section 34	Credit and debit notes
Section 39	Furnishing of returns.
Section 41	Claim of input tax credit and provisional acceptance thereof
Section 43A	Procedure for furnishing return and availing input tax credit
Section 49	Payment of tax, interest, penalty and other amounts
Schedule I	Activities to be treated as supply even if made without consideration
Rule 54	Tax invoice in special cases
Rule 86	Electronic Credit Ledger

16.1 Introduction

Chapter V of CGST Act deals with input tax credit. The availment or otherwise of Input Tax Credit forms the cornerstone in a GST regime. GST can be understood as a system of value-added tax on goods and / or services. It is these provisions of Input Tax Credit that make GST a value-added tax i.e., collection of tax at all points in the supply chain after allowing for credit of taxes paid on inputs / input services and capital goods. The invoice method of value added taxation has been followed in the GST regime too, viz., the tax paid at the time of receipt of goods or services or both would be eligible for set-off against the tax payable on supply of goods or services or both, based on the invoices with a special emphasis on actual payment of tax by the supplier. As on date, there is a debate going on between the tax payer and the Government as to whether the emphasis placed by the Statute on payment of taxes by the Supplier to enable a Recipient to avail credit, is fair or not and whether it adds on to the compliance burden or not. The procedures and restrictions laid down in these provisions are important to make sure that there is seamless flow of credit in the whole scheme of taxation without any misuse.

16.2 Analysis**(i) Relevant definitions:**

- (a) **Taxable person (2(107)):** Means a person who is registered or liable to be registered under section 22 or section 24. As such, the liability to pay tax devolves on every

‘taxable person’ whether or not registration has been sought. A plain reading of the input tax credit provisions makes it clear that input tax credit would be available only to a registered person and to a limited extent pre-registration credits are available under section 18(1).

In case taxes are paid after registration for past periods, the credit for period beyond 1 month from registration may not be available even if it is a bona fide error. This may not be the intention but law does not enable such credits. (However, credit for period beyond 1 month from registration only holds true in cases where a person applies for registration within a period of 30 days from the date on which he becomes liable to obtain registration)

- (b) **Input tax credit:** means the credit of “input tax” in terms of section 2(63).
- (c) **Input tax:** “Input tax” in terms of section 2(62) in relation to a registered person, means the Central tax, State tax, Integrated tax or Union territory tax charged on any supply of goods or services or both made to him and includes:
- integrated goods and service tax (IGST) charged on import of goods.
 - tax payable on reverse charge basis under IGST Act /SGST Act /CGST Act /UTGST Act.
 - but excludes tax paid as a composition levy.
- Section 9(3) and 9(4) of CGST Act (similarly section 5(3) and 5(4) of the IGST Act) levies tax on goods or services or both on reverse charge.
- Therefore, ‘input tax credit’ is the tax paid by a registered person under the Act whether as a forward charge or reverse charge for the use of such goods or services or both in the course or furtherance of his business.
- (d) **Electronic credit ledger:** The input tax credit as self-assessed in the return of registered person shall be credited to electronic credit ledger in accordance with section 41, to be maintained in the manner as may be prescribed. [Section 2(46) read with Section 49(2)].
- (e) **“Capital goods”** means goods, the value of which is capitalised in the books of account of the person claiming the input tax credit and which are used or intended to be used in the course or furtherance of business [Section 2(19)].
- (f) **Input:** “Input” in terms of section 2(59) means
- any goods,
 - other than capital goods,
 - used or intended to be used by a supplier
 - in the course or furtherance of business

- (g) **Input service:** “Input service” in terms of section 2(60) means
- any service
 - used or intended to be used by a supplier
 - in the course or furtherance of business.
- (h) **“Works Contract”** in terms of Section 2(119) means a contract for building, construction, fabrication, completion, erection, installation, fitting out, improvement, modification, repair, maintenance, renovation, alteration or commissioning of any immovable property wherein transfer of property in goods (whether as goods or in some other form) is involved in the execution of such contract;
- (ii) **Section 16**
- (a) **Registered person to avail credit:** Every registered person subject to Section 49 (payment of tax), shall be entitled to take credit of input tax charged on any supply of goods or services or both to him which are used or intended to be used in the course or furtherance of his business. The input tax credit is credited to the electronic credit ledger. Rule 36 of the Central Goods and Service Tax Rules, 2017 provides that input tax credit can be taken on the basis of any of the following documents:
- (i) Invoice issued under section 31 by supplier of goods or services.
 - (ii) Debit note issued under section 34 by supplier of goods or services.
 - (iii) Bill of entry or any similar documents under Custom Act, 1962.
 - (iv) Invoice prepared in respect of supplies made under reverse charge basis issued u/s 31(3)(f).
 - (v) Invoice/ Credit Note issued by ISD for distribution of credit in accordance with Rule 54(1) of CGST Rules, 2017.

It is important to observe the words ‘used by him’ and ‘in his business’ as appearing in section 16(1). These words refer to the registered taxable person in question and not the legal entity. So, input tax paid in a State must not be in relation to the business of a taxable person in another State, albeit belonging to the same person. For example, A Company has Branch-A which is a registered taxable person in Andhra Pradesh conducts conference in a hotel in Lonavla (Maharashtra) where CGST-SGST is charged by the hotel. This Company also has Branch-M which is a registered taxable person in Mumbai, Now the provisions of section 16(1) operate as follows:

- CGST-SGST charged by the hotel in Lonavla (Maharashtra) is ‘used in the business of Branch-A’ in Andhra Pradesh and not in the business of Branch-M in Mumbai.
- Hotel would not be aware about the above fact and would not resist to issue the bill in the name of Branch-M because both are branches of the same Company

- Since, CGST-SGST has been charged by the hotel, input tax credit would not be available to Branch-A as tax paid in Maharashtra is not a creditable tax in Andhra Pradesh
 - Branch-M may be compelled to forego the tax paid to the hotel. However, there may be an urge to save this loss by providing the GSTIN of Branch-M to the hotel. In fact, the Company is rightly required to obtain ISD registration in Maharashtra and distribute this credit entirely to Andhra Pradesh.
 - But, Branch-M in Mumbai cannot justify this input tax credit as it is not **'used by him'** in **'his business'** but it is 'used by another' in 'that others business'
 - Care should be taken to verify 'whose' business each input tax credit relates to;
 - If nexus is established between the services of the hotel and the 'business' of Branch-M, input tax credit may be availed by Branch-M. Nexus emerges if inter-branch supply of services occurs between Branch-M and Branch-A
 - Alternatively, based on the amount of credits of Branch-A lying as CGST + MGST credits, the company may decide to obtain ISD registration in the State of Maharashtra and transfer the credits as IGST from Maharashtra to Andhra Pradesh
- (b) **Wastage of inputs in the course of production:** Credit in respect of inputs that may have been wasted during the course of production of finished products does not cease to be *'used or intended to be used' in the course or furtherance of business*. As such, there is no restriction to read into the language of section 16 (1). In fact, the full extent of credit would be available whether the extent of wastage of inputs in the course of production of finished goods is within normal wastage norms or even exceeds that to be called abnormal wastage of inputs. Unless there is a diversion of inputs (in respect of which credit has been availed), there is no embargo on availment and retention of input tax credit. Section 17(5)(h) restricts credit on "goods lost" since these can no longer be used for the purpose of business but does not provide for restriction of credits on "loss of goods" which could be a process loss inherent to the nature of product on which credit has been availed. Therefore, "goods lost" must be given a completely different meaning as compared to "goods lost during production / process or a normal / abnormal loss".
- (c) **Input-Output nexus:** The erstwhile CENVAT Credit Rules, 2004 allowed for credits on input and input services used for manufacture of excisable goods or for rendering taxable services. The credit under GST law is available on procurements which are "used" or "intended to be used" in the course or furtherance of business. Hence, any procurements though not having any remote connection with the manufacturing or rendering of outward supplies, would also qualify for input tax credit so long as it is used or intended to be used for the purpose of business. Eg. Air Conditioner installed

in the cabin of the Managing Director, Maharashtra has no correlation with the car manufactured at the Company Plant in Gujarat but the credit of tax relating to such air conditioner would be available since the air conditioner has been installed for the purpose of business.

- (d) **Costing-pricing inter-relationship:** Credit may be availed in respect of inputs whose cost may not be included in the pricing of the product and consequently, not included in the transaction value – this may create a concern as to whether this credit is admissible or not. As explained by the Hon'ble Supreme Court in CCE, Pune v. Dai Ichi Karkaria 1999 (112) ELT 353, the nature of Modvat scheme is such that the cost of purchase of inputs lowered due to availment of credit, does not immediately, directly and proportionately impact the assessable value of the finished product manufactured using the inputs. The ratio of this judgement must be understood to continue to be applicable in the context of GST law, as well. As such, neither availment of credit nor its discontinuation can be alleged to have an immediate, direct and proportionate effect on the transaction value under section 15. However, the implications under Anti-Profiteering provisions of the GST Law should be borne in mind while deciding on the pricing and net benefit of tax due to introduction of GST.
- (e) **Time limit to avail the input tax credit:** A registered person is not entitled to avail input tax credit on tax invoice/ debit notes after the due date of furnishing of the return under section 39 for the month of September of the subsequent financial year or furnishing of the relevant annual return, whichever is earlier. In fact, not only is registration a pre-requisite (see, 'registered taxable person' shall be entitled to claim credit) but filing of return under section 39 is also a requirement. Input tax credit is a right that does not 'vest' until the last of conditions in section 16(2) are fulfilled. Until then, this right i.e., input tax credit is *inchoate* (or incomplete or in-formation) and not a vested right. Rights that are not yet vested can lapse by limitation unless effective steps to actualize those rights are taken by the person. And once the right stands vested, it becomes indefeasible except by operation of subsequent inherent conditions. In other words, input tax credit which is a right in law of the taxable person is not fully mature and is not available to the taxable person until all pre-conditions (steps to actualize available rights) have been taken. Section 16(2) lays down these steps that can be taken immediately or in course of time. And once all these steps are taken then the right i.e 'available' becomes a right that can be 'availed'. After the credit stands availed, it is available without any time limit. Section 18(4) provides a condition (known at the time of availing credit) that this credit will be reversed if the outward supplies become exempted. Other than this situation, the credit availed is permanently available to the taxable person. Now, in a situation where the credit that is 'available' is somehow delayed and 'not availed', it would still be available but not beyond the limitation prescribed in Section 16(4). Once the limitation prescribed in section 16(4) sets in, the credit which is 'not availed' by virtue of the limitation prescribed is proper in view of the

principle of reaching finality in respect of all 'available' credits that may 'not' be intended to be availed. Therefore in case of doubts one can avail the credit and then reverse under protest under intimation to revenue. This would ensure that the time limitation would not be the reason for non availment once clarity emerges from Courts.

Section 16(4) provides for time limit for availment of credit for Invoices and Debit Notes. Bill of Entry is not mentioned in Section 16(4) and hence it appears that there is no time limit for availment of credit in case of Bill of Entry. However, Table 8 of Form GSTR 9 (Annual Return format) suggests that credit related to bill of entry not availed within the due date will lapse.

It would be important to note that the due date for availing credit on debit notes is linked to the financial year to which invoice relating to such debit note pertains to and not the financial year in which the debit note has been issued.

Illustration

Document Type	Document Date	Due date for availing credit*
Invoice	05.07.2018	Returns for the month of September 2019
Debit Note	05.07.2018 (Debit Note relates to invoice raised on 05.03.2018)	Returns for the month of September 2018
Debit Note	05.12.2018 (Debit Note relates to invoice raised on 05.03.2018)	Returns for the month of September 2018 – Effectively, credit cannot be availed for debit notes issued after 6 months from the end of the financial year to which the invoice pertains to, though there is no time limit for issuance of Debit Note in Section 34 (unlike the time limit prescribed for Credit Notes under the said Section)

* assumed that Annual Returns have been filed after the filing of the returns for the month of September

- (f) **Deemed receipt of goods:** Section 16 permits a registered person to avail credit only after he has received the said goods or services or both. However, in case of bill to-ship to transactions (including where such goods are sent for job work), by which the registered person instructs his supplier to ship the goods to another person on his behalf, the date of receipt of goods by such another person shall be deemed to be the date of receipt of goods by the said registered person.

Therefore what exactly does 'received' mean in this context? Does it refer to actual receipt of goods at factory premises or even constructive receipt of goods would

suffice? Broadly, receipt of goods may be said to be complete when goods have been supplied as per the recipient's instructions and the supplier is discharged from any further liability on such goods. The delivery must be complete in all respects to the utmost satisfaction of the recipient. The point of acceptance in cases of pre requisite of quality control may have to be clear.

For example, an interesting scenario may be encountered when goods imported by a registered person are supplied directly to his customers in India from the port without bringing such imported goods (physically) to his factory premises. Would the importer still be entitled to ITC of IGST paid on imported goods although such goods were never received at his factory premises? The answer is 'Yes'. The importer, after fulfilling all the import formalities is deemed to have received the goods and thus, eligible to avail input tax credit of IGST paid on imports.

This scenario, i.e. in bill-to-ship-to model, where it is amended to include services also which deemed that goods are provided by recipient when the supplier delivers the goods to any other person on the direction of and on account the recipient shall be applicable in case of such services also. However, please note that this fiction for delivery of goods or services is not an attempt at encroaching upon the Place of Supply provisions of IGST Act but merely to satisfy the conditions for availment of credit in certain cases where someone else collects goods or enjoys services.

- (g) **Goods received in instalments:** If goods are received in instalments against a single invoice, credit can be availed upon receipt of last instalment of goods.

Illustration – A consignment of coal is to be dispatched from Kolkata to Mumbai using five trucks. An invoice was issued to the recipient on March 30, 2018. Four trucks reached the claimant by March 30, 2018 but the truck carrying the final lot of the consignment reached the recipient only on April 2, 2018. In this case, input tax credit for the entire consignment can be availed only in the month of April 2018.

- (h) **Receipt of Services:** The recipient can claim credit only upon receipt of services except a situation mentioned in Explanation to Section 16(2)(b). In the commercial world, while it is easy to demonstrate receipt of goods (by way of physical stock, e-way bill, GRN etc), the same is not to be in case of services which is an intangible in nature. Determination of actual receipt of services could be a formidable task especially when the contracting period for provision of service extends beyond a tax period but consideration is received in advance. .

Explanation to Section 16(2)(b) has been amended to include services. It has been stated that the registered person will be deemed to have received the services where the services are provided by the supplier to any person on direction of and on account of such registered person.

The person receiving any services may be different from the person who is liable to make the payment as the recipient under the law. The definition of recipient under the GST law has been defined to mean the person liable to make the payment. However, there are multiple cases where the payment is made by a particular person but the services are received by another person. In such a situation, the person liable to make the payment will be deemed to have received the services.

For instance, X is providing advisory services to Z for which the payment is agreed to be made by Y. In this situation, Y will be deemed to have received the services as per the new deeming fiction in the Explanation to Section 16(2). Thereby, Y will be allowed to avail input tax credit even though he is not in actual receipt of the services.

- (i) **Failure to pay to supplier of goods or service or both, the value of supply and tax thereon:** Where the recipient of goods or services or both have failed to pay the supplier within 180 days from date of invoice, input tax credit availed, in proportion to such unpaid consideration shall be added to the recipient's output tax liability along with interest as may be applicable. Such non-payment of the value of invoice must be disclosed in FORM-GSTR 2 filed for the month immediately following the expiry of 180 days from the date of issue of invoice. However, such input tax credit may be reclaimed as and when the unpaid amount (including taxes) is subsequently paid.

One may note that this condition shall not apply to supplies that are liable to tax under reverse charge and supplies made without consideration as specified in Schedule I. Conspicuous by its absence within this *carved out* provision is the import of goods. While reverse charge is excluded from the condition of having to make payment within 180 days, GST paid on import of goods does not fall within the ambit of reverse charge under section 9(3) or 9(4) of the CGST Act or Section 5(3) or Section 5(4) of the IGST Act although IGST paid on import of goods is akin to reverse charge. The question that now arises is - whether there can be reverse charge liability other than under section 9(3) and 9(4). The definition in section 2(98) does not permit such extended application. The privilege to prescribe pre-conditions for vesting of right to input tax credit belongs to section 16 and therefore, there is no other provision from where any overriding right to claim credit on goods imports may be borrowed or imputed. On the other hand, IGST paid under reverse charge on import of services is covered under Section 5(3) of the IGST Act as a result of which an importer of service would be entitled to credit of IGST paid even if the service provider remains unpaid beyond the said period of 180 days. Based on the above reasoning, credit of taxes paid on import of goods will not be available if the payment of value of goods is not made within 180 days. An alternative argument that is possible to take up is that the person who avails the credit is required to pay the value of supplies within 180 days from the date of issue of invoice. The term invoice has been defined to mean invoice raised under Section 31 and Section 31 provides that invoice can be issued by a registered person. Since the vendor outside India is not registered in India, the invoice raised by him is not an invoice in terms of

Section 31 and hence the criteria of 180 days is not applicable even in case of import of goods since the 'invoice' as per GST Laws is missing in this transaction.

One may however wonder the need for such a provision under the GST law, given the fact that payment of consideration is a private arrangement between the parties to the contract. The Government is needlessly meddling with contractual payment terms by dangling the sword of ITC reversal over the neck of the recipient of supply. The fact that the Government receives its tax when time of supply is triggered irrespective of when consideration is actually paid, adequately protects the interest of revenue thus failing to justify the need for such a provision.

It would be relevant to note that Section 15 of the CGST Act deals with valuation of supplies and provides for addition in the value of supply in case the price is not sole consideration or if the transacting parties are related. Such addition is made for GST purposes (to arrive at the tax payable) but commercially, such amount is neither recorded in the books nor paid by the transacting parties and hence in all such cases where additions are made to the value of supply, the recipient will be denied the credit since he does not make payment to the extent of such additions. The CGST Rules have accordingly been amended wef June 13, 2018 to provide that such additions made under Section 15(2)(b) will be deemed to have been paid by the recipient to the supplier.

- (j) **Capital goods on which depreciation is claimed:** Input tax credit shall not be allowed on the tax component of the cost of capital goods and plant and machinery if depreciation on such tax component has been claimed under the provisions of the Income Tax Act, 1961.

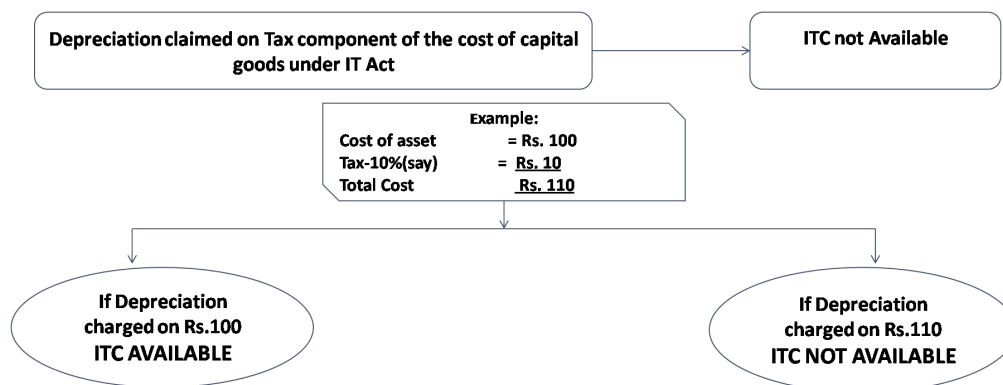

There may however, be instances where an assessee is unable to avail input tax credit on capital goods for various reasons, say for example, the department has objected to it. In such cases, assessee may decide to capitalize the tax component and avail depreciation on tax component also. Whenever the dispute relating to eligibility of input tax credit on capital goods is resolved, assessee may avail Input Tax Credit and correspondingly reverse the depreciation claimed under Income Tax Act, 1961 on tax

component. Similar provisions existed under CENVAT Credit Rules and the Hon'ble Gujarat High Court in the case Genus Electrotech Limited reported in 2013 (296) ELT 175 (Guj.) held that after reversal of entry for depreciation, assessee could avail credit. The ratio of this decision under the CENVAT Credit Rules, 2004 will equally hold good under the GST law since the provisions are similar. Although, there was no time limit for availing tax credit on capital goods under the CENVAT Credit Rules, 2004, under the GST law, credit cannot be availed after the due date of filing the returns for the month of September following the end of the financial year or the date of filing the annual return, whichever is earlier. It would be worthwhile to note that Rule 37(4) which provides for re-availing of input tax credit for an unrestricted period is applicable only in respect of ITC reversed earlier for non-payment of consideration to the supplier within 180 days and not for re-claim of ITC on account of reversal of depreciation as discussed above.

It may be interesting to note that Section 16(3) states that input tax credit shall not be allowed in cases where depreciation has been claimed on "the tax component of the cost of capital goods **and plant and machinery** under the provisions of the Income-tax Act, 1961." The use of the words plant and machinery in addition to 'capital goods' requires special attention. Capital Goods have been defined to mean goods used or intended to be used in the course or furtherance of business, the value of which has been capitalised in the books of account. Going by the above definition, 'Plant and machinery' in respect of which depreciation is to be claimed would *per se* fall within the ambit of capital goods as defined above. This special mention of 'plant and machinery' in addition to capital goods may be interpreted to mean that merely charging the value of plant and machinery (including the tax component thereof) to the Profit and Loss account could invalidate the claim of the registered person to input tax credit even though the asset (i.e., Plant and Machinery) has not been capitalised. The intention should be that what is not "revenue" in nature only can be capitalised and therefore whatever is not capitalised would be eligible. It appears that this contentious issue would only stand resolved over time.

In summary, among others the following facts are crucial for availment of Input tax credit:

- (a) The claimant should be registered under the GST Law to avail the input tax credit (except for certain exceptions covered under Section 18)
- (b) The goods and/ or services must be used "by him" in the course or furtherance "of his" business.
- (c) Possession of original tax Invoice/Supplementary Invoice/ Debit note/ ISD invoice/ Bill of Entry and other related documents is a must.
- (d) The said document must contain all the particulars prescribed / specified in Rule 46 of Central Goods and Service Tax Rules, 2017 relating to a Tax Invoice. It may be noted that the Tax Invoice or such other document can contain additional details other than those prescribed but NO LESS. For details of invoice, see Chapter VI of the CGST Rules. This requirement has been relaxed wef September 4, 2018. The registered person can avail input tax credit if the documents contain the following minimum details

- a. Amount of tax charged
 - b. Description of goods or services
 - c. Total value of supply of goods or services or both
 - d. GSTIN of the supplier and recipient
 - e. Place of supply in case of inter-State supply
- (e) Supplier of goods and/ or services must upload the details of such documents in the common portal i.e. GSTN. Subject to section 41 and 43A being claim of ITC and provisional acceptance thereof, the supplier must have remitted the tax charged on such supplies. The new return filing mechanism (Section 43A) may allow taking of input tax credit to the recipient in certain situations and subject to certain conditions even if payment of tax is not made by the supplier. So, payment of tax by the supplier has been made subject to the procedure in the new return filing mechanism which is yet to be notified.

CGST Amendment Act, 2017

Section 43A has been introduced to give effect to the revised return filing and credit availment mechanism. Currently, availment of credit is subject to Section 41 (provisional acceptance of credit) which is now being linked to revised return filing process i.e. Section 43A

- (f) Vesting condition for claiming input tax credit is the return u/s 39 and not the supply *per se*.
- (g) The claimant should have received the goods / services. Input tax credit in case of supplies in installment, would be on receipt of last installment of goods.
- (h) The law casts an obligation on the recipient of supply availing credit to effect payment to the supplier within a period of 180 days from the date of invoice. If such payment is not effected/ partially effected by the recipient to the supplier, Rule 37 obligates reversal/ proportionate reversal of input tax credit so availed leading to consequential levy of tax and interest.
 Proviso to section 16(2) provides that the taxable person shall be entitled to avail input tax credit after making payment of the amount towards value of supply of goods or services or both along with tax payable thereon. Further, Rule 37(4) provides that the time limit specified under section 16(4) shall not be applicable for such recredit.
- (i) Claim of depreciation on the GST component disqualifies a recipient of Capital goods and plant and machinery from availment of input tax credit.
- (j) ITC cannot be availed after the due date of filing the return for September month of the next financial year or on furnishing the Annual Return whichever is earlier.
- (k) No registered person is permitted to avail any input tax credit pursuant to an order of demand on account of fraud, willful misstatement, or suppression of fact.

Note: The last point is important as many of the cases in a routine manner the show cause notice would invoke these mala fide intentions and if not contested, the ITC would not be available to the receiver even if otherwise eligible.

16.3 Issues and Concerns

- (i) A consignment of coal is to be dispatched from Kolkata to Mumbai through five trucks for which the invoice was sent along with the first truck. Four trucks reached the claimant by March 30, 2018 but the truck carrying the final lot of the consignment falls down a gorge and is never received. Would this deny the input tax credit that should have otherwise been available on coal received on the first four lots? The answer is 'No'. The recipient in Mumbai needs to obtain a credit note from the supplier in Kolkata in respect of that lot which would never be received and accordingly avail ITC relating to the coal received at the business premises.
- (ii) Section 16 allows a recipient of supply to avail credit only when he has received the goods or services or both. For example, in an Annual Maintenance Contracts for machines entered into on November 1st, 2017, the supplier is under an obligation to render services arising over a period of 12 months (ending 31st October, 2018) but in respect of which an invoice is raised and consideration is received on the date of entering into the agreement i.e 1st November 2017 in this case. In such cases, the fate of input tax credit contained in the said invoice is left hanging in the balance considering the fact that input tax credit in respect of an invoice received during the year cannot be claimed after the due date for filing the return for the month of September of the succeeding year. In the given case, the receipt of service is said to be completed (i.e., AMC period ends) on October 31st, 2018, while the time limit for claiming credit is October 20th, 2018. Possible solution to overcome this situation could be to convert the AMC into Monthly / Quarterly Maintenance Contracts, if agreeable to the supplier. Alternatively, could it be interpreted that an AMC, is primarily an assurance which is received on the date of entering into the AMC and what follows is only a continuing obligation of the supplier and hence the service may be deemed to have been received on the date of commencement of the AMC. The above issue also arises in case of an insurance contract. It is possible for one to interpret or read down the law in such cases since every business operates on a concept of going concern. These issues would most certainly be put to test in the times to come.
- (iii) In case of a recipient who has reversed credit on account of non-payment of consideration within 180 days, can he avail credit in instalments as and when the payment is made to the supplier or should he reclaim the credit only when the entire amount including taxes has been paid to the supplier. Given that the third proviso to Section 16(2)(d) allows re-availment of credit on payment of 'the amount towards the value of supply of goods or services or both' and not 'an amount', reading strictly it may be construed that the entire amount would have to be paid for re-availment of credit earlier reversed. Consideration paid which is non-monetary form is also a consideration and for the scheme to work one needs to read harmoniously. Some experts argue that

the expression 'the amount towards the value of supply of goods or services or both' must be necessarily construed that it imply "whole of the value of supply". It may also be possible to understand that if the terms of payments envisage payment in part even after a period of 180 days that such proportionate could be availed from time to time depending on the amount of payment. It is a common practice that some deductions are there in the invoice without GST being deducted. Then can it be said that the whole consideration has not been paid and credit denied until the whole amount with taxes paid? The credit should be available for part payments, value deductions by customer without impacting the GST as well as non-monetary payments. These issues may be put to test in the days to come.

16.4 Comparative review

Aspect	Credit under erstwhile system	Input tax credit under GST
Definition of "capital goods"	Defined in Cenvat Credit Rules	Comparatively wider definition.
Definition of "input"	Defined in Cenvat credit Rules having inclusion and exclusion limbs.	Exhaustive definition and does not contain inclusion or exclusion limb.
Definition of "input services"	Defined in Cenvat credit Rules which has inclusion and exclusion limb.	Exhaustive definition and does not contain inclusion or exclusion limb.
Electronic credit ledger	Similar to CENVAT credit register maintained in Form RG23A	Electronic credit ledger required to be maintained for crediting and utilising input tax credit

While CENVAT Credit Rules identified three components for credit availment, namely Input, Input Services and Capital Goods, the GST law allows input tax credit on goods and services with goods being further classified into inputs and capital goods in certain cases.

Statutory Provisions- Effective from 1st July, 2017 to 31st January, 2019

17. Apportionment of credit and blocked credit

- (1) *Where the goods or services or both are used by the registered person partly for the purpose of any business and partly for other purposes, the amount of credit shall be restricted to so much of the input tax as is attributable to the purposes of his business.*
- (2) *Where the goods or services or both are used by the registered person partly for effecting taxable supplies including zero-rated supplies under this Act or under the Integrated Goods and Services Tax Act, and partly for effecting exempt supplies*

under the said Acts, the amount of credit shall be restricted to so much of the input tax as is attributable to the said taxable supplies including zero-rated supplies.

(3) *The value of exempt supply under sub-section (2) shall be such as may be prescribed, and shall include supplies on which the recipient is liable to pay tax on reverse charge basis, transactions in securities, sale of land and, subject to clause (b) of paragraph 5 of Schedule II, sale of building.*

(4) *A banking company or a financial institution including a non-banking financial company, engaged in supplying services by way of accepting deposits, extending loans or advances shall have the option to either comply with the provisions of sub-section (2), or avail of, every month, an amount equal to fifty per cent of the eligible input tax credit on inputs, capital goods and input services in that month and the rest shall lapse.*

Provided that the option once exercised shall not be withdrawn during the remaining part of the financial year.

Provided further that the restriction of fifty per cent. shall not apply to the tax paid on supplies made by one registered person to another registered person having the same Permanent Account Number

(5) *Notwithstanding anything contained in sub-section (1) of section 16 and subsection (1) of section 18, input tax credit shall not be available in respect of the following namely:*

(a) *motor vehicles and other conveyances except when they are used—*

(i) *for making the following taxable supplies, namely:—*

(A) *further supply of such vehicles or conveyances ; or*

(B) *transportation of passengers; or*

(C) *imparting training on driving, flying, navigating such vehicles or conveyances;*

(ii) *for transportation of goods;*

(b) *the following supply of goods or services or both—*

(i) *food and beverages, outdoor catering, beauty treatment, health services, cosmetic and plastic surgery except where an inward supply of goods or services or both of a particular category is used by a registered person for making an outward taxable supply of the same category of goods or services or both or as an element of a taxable composite or mixed supply;*

(ii) *membership of a club, health and fitness centre;*

(iii) *rent-a-cab, life insurance and health insurance except where—*

(A) *the Government notifies the services which are obligatory for an*

employer to provide to its employees under any law for the time being in force; or

(B) such inward supply of goods or services or both of a particular category is used by a registered person for making an outward taxable supply of the same category of goods or services or both or as part of a taxable composite or mixed supply; and

(iv) travel benefits extended to employees on vacation such as leave or home travel concession;

(c) works contract services when supplied for construction of an immovable property (other than plant and machinery) except where it is an input service for further supply of works contract service;

(d) goods or services or both received by a taxable person for construction of an immovable property (other than plant and machinery) on his own account, including when such goods or services or both are used in the course or furtherance of business;

Explanation. - For the purpose of clause (c) and (d), the expression "construction" includes re-construction, renovation, additions or alterations or repairs, to the extent of capitalization, to the said immovable property.

(e) goods or services or both on which tax has been paid under section 10;

(f) goods or services or both received by a non-resident taxable person except on goods imported by him;

(g) goods or services or both used for personal consumption;

(h) goods lost, stolen, destroyed, written off or disposed of by way of gift or free samples; and

(i) any tax paid in accordance with the provisions of sections 74, 129 and 130.

(6) The Government may prescribe the manner in which the credit referred to in sub-sections (1) and (2) may be attributed.

Explanation. For the purposes of this Chapter and Chapter VI, the expression 'plant and machinery' means apparatus, equipment and machinery fixed to earth by foundation or structural support that are used for making outward supply of goods or services or both and includes such foundation and structural supports but excludes

(i) land, building or any other civil structures,

(ii) telecommunication towers; and

(iii) pipelines laid outside the factory premises

Statutory Provisions- Effective from 1st February 2019 vide The Central Goods & Services Tax Amendment Act,2018

17. Apportionment of credit and blocked credit

(1) *Where the goods or services or both are used by the registered person partly for the purpose of any business and partly for other purposes, the amount of credit shall be restricted to so much of the input tax as is attributable to the purposes of his business.*

(2) *Where the goods or services or both are used by the registered person partly for effecting taxable supplies including zero-rated supplies under this Act or under the Integrated Goods and Services Tax Act, and partly for effecting exempt supplies under the said Acts, the amount of credit shall be restricted to so much of the input tax as is attributable to the said taxable supplies including zero-rated supplies.*

(3) *The value of exempt supply under sub-section (2) shall be such as may be prescribed, and shall include supplies on which the recipient is liable to pay tax on reverse charge basis, transactions in securities, sale of land and, subject to clause (b) of paragraph 5 of Schedule II, sale of building.*

Explanation.—For the purposes of this sub-section, the expression “value of exempt supply” shall not include the value of activities or transactions specified in Schedule III, except those specified in paragraph 5 of the said Schedule]

(4) *A banking company or a financial institution including a non-banking financial company, engaged in supplying services by way of accepting deposits, extending loans or advances shall have the option to either comply with the provisions of sub-section (2), or avail of, every month, an amount equal to fifty per cent of the eligible input tax credit on inputs, capital goods and input services in that month and the rest shall lapse.*

Provided that the option once exercised shall not be withdrawn during the remaining part of the financial year.

Provided further that the restriction of fifty per cent. shall not apply to the tax paid on supplies made by one registered person to another registered person having the same Permanent Account Number

(5) *Notwithstanding anything contained in sub-section (1) of section 16 and subsection (1) of section 18, input tax credit shall not be available in respect of the following namely:*

(c) *motor vehicles for transportation of persons having approved seating capacity of not more than thirteen persons (including the driver), except when they are used for making the following taxable supplies, namely:—*

(A) *further supply of such motor vehicles; or*

- (B) *transportation of passengers; or*
- (C) *imparting training on driving such motor vehicles;*
- (aa) *vessels and aircraft except when they are used—*
- (i) *for making the following taxable supplies, namely:—*
- (A) *further supply of such vessels or aircraft; or*
- (B) *transportation of passengers; or*
- (C) *imparting training on navigating such vessels; or*
- (D) *imparting training on flying such aircraft;*
- (ii) *for transportation of goods;*
- (ab) *services of general insurance, servicing, repair and maintenance in so far as they relate to motor vehicles, vessels or aircraft referred to in clause (a) or clause (aa):*
- Provided that the input tax credit in respect of such services shall be available—*
- (i) *where the motor vehicles, vessels or aircraft referred to in clause (a) or clause (aa) are used for the purposes specified therein;*
- (ii) *where received by a taxable person engaged—*
- (I) *in the manufacture of such motor vehicles, vessels or aircraft; or*
- (II) *in the supply of general insurance services in respect of such motor vehicles, vessels or aircraft insured by him;*
- (d) *the following supply of goods or services or both—*
- (i) *food and beverages, outdoor catering, beauty treatment, health services, cosmetic and plastic surgery, leasing, renting or hiring of motor vehicles, vessels or aircraft referred to in clause (a) or clause (aa) except when used for the purposes specified therein, life insurance and health insurance:*
- Provided that the input tax credit in respect of such goods or services or both shall be available where an inward supply of such goods or services or both is used by a registered person for making an outward taxable supply of the same category of goods or services or both or as an element of a taxable composite or mixed supply;*
- (ii) *membership of a club, health and fitness centre; and*
- (iii) *travel benefits extended to employees on vacation such as leave or home travel concession.*
- Provided that the input tax credit in respect of such goods or services or both shall be available, where it is obligatory for an employer to provide to its employees under any law for the time being in force.*

(c) works contract services when supplied for construction of immovable property, (other than plant and machinery), except where it is an input service for further supply of works contract service;

(d) goods or services or both received by a taxable person for construction of an immovable property (other than plant and machinery) on his own account, including when such goods or services or both are used in the course or furtherance of business;

Explanation. - For the purpose of clause (c) and (d), the expression "construction" includes re-construction, renovation, additions or alterations or repairs, to the extent of capitalization, to the said immovable property.

(e) goods or services or both on which tax has been paid under section 10;

(f) goods or services or both received by a non-resident taxable person except on goods imported by him;

(g) goods or services or both used for personal consumption;

(h) goods lost, stolen, destroyed, written off or disposed of by way of gift or free samples; and

(i) any tax paid in accordance with the provisions of sections 74, 129 and 130.

(6) The Government may prescribe the manner in which the credit referred to in sub-sections (1) and (2) may be attributed.

Explanation. For the purposes of this Chapter and Chapter VI, the expression 'plant and machinery' means apparatus, equipment and machinery fixed to earth by foundation or structural support that are used for making outward supply of goods or services or both and includes such foundation and structural supports but excludes

(i) land, building or any other civil structures,

(ii) telecommunication towers; and

(iii) pipelines laid outside the factory premises

Extract of the CGST Rules, 2017

38. Claim of credit by a banking company or a financial institution.

A banking company or a financial institution, including a non-banking financial company, engaged in the supply of services by way of accepting deposits or extending loans or advances that chooses not to comply with the provisions of sub-section (2) of section 17, in accordance with the option permitted under sub-section (4) of that section, shall follow the following procedure, namely,-

(a) the said company or institution shall not avail the credit of,-

- (i) the tax paid on inputs and input services that are used for non-business purposes; and
 - (ii) the credit attributable to the supplies specified in sub-section (5) of section 17, in FORM GSTR-2;
- (b) the said company or institution shall avail the credit of tax paid on inputs and input services referred to in the second proviso to sub-section (4) of section 17 and not covered under clause (a);
- (c) fifty per cent. of the remaining amount of input tax shall be the input tax credit admissible to the company or the institution and shall be furnished in FORM GSTR- 2;
- (d) the amount referred to in clauses (b) and (c) shall, subject to the provisions of sections 41, 42 and 43, be credited to the electronic credit ledger of the said company or the institution.

42. Manner of determination of input tax credit in respect of inputs or input services and reversal thereof

- 1) The input tax credit in respect of inputs or input services, which attract the provisions of sub-section (1) or sub-section (2) of section 17, being partly used for the purposes of business and partly for other purposes, or partly used for effecting taxable supplies including zero rated supplies and partly for effecting exempt supplies, shall be attributed to the purposes of business or for effecting taxable supplies in the following manner, namely,-
- a) the total input tax involved on inputs and input services in a tax period, be denoted as 'T';
 - b) the amount of input tax, out of 'T', attributable to inputs and input services intended to be used exclusively for the purposes other than business, be denoted as 'T1';
 - c) the amount of input tax, out of 'T', attributable to inputs and input services intended to be used exclusively for effecting exempt supplies, be denoted as 'T2';
 - d) the amount of input tax, out of 'T', in respect of inputs and input services on which credit is not available under sub-section (5) of section 17, be denoted as 'T3';
 - e) the amount of input tax credit credited to the electronic credit ledger of registered person, be denoted as 'C1' and calculated as-

$$C1 = T - (T1 + T2 + T3);$$
 - f) the amount of input tax credit attributable to inputs and input services intended to be used exclusively for effecting supplies other than exempted but including zero rated supplies, be denoted as 'T4';
 - g) 'T1', 'T2', 'T3' and 'T4' shall be determined and declared by the registered person at the invoice level in FORM GSTR-2;

- h) *input tax credit left after attribution of input tax credit under clause (g) shall be called common credit, be denoted as 'C2' and calculated as:*

$$C2 = C1 - T4;$$

- i) *the amount of input tax credit attributable towards exempt supplies, be denoted as 'D1' and calculated as*

$$D1 = (E \div F) \times C2 \text{ where,}$$

'E' is the aggregate value of exempt supplies during the tax period, and

'F' is the total turnover in the State of the registered person during the tax period:

Provided that where the registered person does not have any turnover during the said tax period or the aforesaid information is not available, the value of 'E/F' shall be calculated by taking values of 'E' and 'F' of the last tax period for which the details of such turnover are available, previous to the month during which the said value of 'E/F' is to be calculated;

Explanation: For the purposes of this clause, it is hereby clarified that the aggregate value of exempt supplies and the total turnover shall exclude the amount of any duty or tax levied under entry 84 of List I of the Seventh Schedule to the Constitution and entry 51 and 54 of List II of the said Schedule;

- j) *the amount of credit attributable to non-business purposes if common inputs and input services are used partly for business and partly for non-business purposes, be denoted as 'D2', and shall be equal to five per cent. of C2; and*
- k) *the remainder of the common credit shall be the eligible input tax credit attributed to the purposes of business and for effecting supplies other than exempted supplies but including zero rated supplies and shall be denoted as 'C3', where,-*

$$C3 = C2 - (D1 + D2);$$

- l) *the amount 'C3' shall be computed separately for input tax credit of central tax, State tax, Union territory tax and integrated tax;*
- m) *the amount equal to aggregate of 'D1' and 'D2' shall be added to the output tax liability of the registered person:*

Provided that where the amount of input tax relating to inputs or input services used partly for the purposes other than business and partly for effecting exempt supplies has been identified and segregated at the invoice level by the registered person, the same shall be included in 'T1' and 'T2' respectively, and the remaining amount of credit on such inputs or input services shall be included in 'T4'.

- 2) *The input tax credit determined under sub-rule (1) shall be calculated finally for the financial year before the due date for furnishing of the return for the month of September following the end of the financial year to which such credit relates, in the manner specified in the said sub-rule and-*

- a) where the aggregate of the amounts calculated finally in respect of 'D1' and 'D2' exceeds the aggregate of the amounts determined under sub-rule (1) in respect of 'D1' and 'D2', such excess shall be added to the output tax liability of the registered person in the month not later than the month of September following the end of the financial year to which such credit relates and the said person shall be liable to pay interest on the said excess amount at the rate specified in sub-section (1) of section 50 for the period starting from the first day of April of the succeeding financial year till the date of payment; or
- b) where the aggregate of the amounts determined under sub-rule (1) in respect of 'D1' and 'D2' exceeds the aggregate of the amounts calculated finally in respect of 'D1' and 'D2', such excess amount shall be claimed as credit by the registered person in his return for a month not later than the month of September following the end of the financial year to which such credit relates.

43. Manner of determination of input tax credit in respect of capital goods and reversal thereof in certain cases

1) Subject to the provisions of sub-section (3) of section 16, the input tax credit in respect of capital goods, which attract the provisions of sub-sections (1) and (2) of section 17, being partly used for the purposes of business and partly for other purposes, or partly used for effecting taxable supplies including zero rated supplies and partly for effecting exempt supplies, shall be attributed to the purposes of business or for effecting taxable supplies in the following manner, namely,-

- a) the amount of input tax in respect of capital goods used or intended to be used exclusively for non-business purposes or used or intended to be used exclusively for effecting exempt supplies shall be indicated in FORM GSTR-2 and shall not be credited to his electronic credit ledger;
- b) the amount of input tax in respect of capital goods used or intended to be used exclusively for effecting supplies other than exempted supplies but including zero rated supplies shall be indicated in FORM GSTR-2 and shall be credited to the electronic credit ledger;
- c) the amount of input tax in respect of capital goods not covered under clauses (a) and (b), denoted as 'A', shall be credited to the electronic credit ledger and the useful life of such goods shall be taken as five years from the date of the invoice for such goods:

Provided that where any capital goods earlier covered under clause (a) is subsequently covered under this clause, the value of 'A' shall be arrived at by reducing the input tax at the rate of five percentage points for every quarter or part thereof and the amount 'A' shall be credited to the electronic credit ledger;

Explanation.- An item of capital goods declared under clause (a) on its receipt shall not attract the provisions of sub-section (4) of section 18, if it is subsequently

covered under this clause.

- d) the aggregate of the amounts of 'A' credited to the electronic credit ledger under clause (c), to be denoted as 'Tc', shall be the common credit in respect of capital goods for a tax period:

Provided that where any capital goods earlier covered under clause (b) is subsequently covered under clause (c), the value of 'A' arrived at by reducing the input tax at the rate of five percentage points for every quarter or part thereof shall be added to the aggregate value 'Tc';

- e) the amount of input tax credit attributable to a tax period on common capital goods during their useful life, be denoted as 'Tm' and calculated as-

$$T_m = T_c \div 60$$

- f) the amount of input tax credit, at the beginning of a tax period, on all common capital goods whose useful life remains during the tax period, be denoted as 'Tr' and shall be the aggregate of 'Tm' for all such capital goods;
- g) the amount of common credit attributable towards exempted supplies, be denoted as 'Te', and calculated as-

$$T_e = (E \div F) \times T_r$$

where,

'E' is the aggregate value of exempt supplies, made, during the tax period,
and

'F' is the total turnover of the registered person during the tax period:

Provided that where the registered person does not have any turnover during the said tax period or the aforesaid information is not available, the value of 'E/F' shall be calculated by taking values of 'E' and 'F' of the last tax period for which the details of such turnover are available, previous to the month during which the said value of 'E/F' is to be calculated;

Explanation.- For the purposes of this clause, it is hereby clarified that the aggregate value of exempt supplies and the total turnover shall exclude the amount of any duty or tax levied under entry 84 of List I of the Seventh Schedule to the Constitution and entry 51 and 54 of List II of the said Schedule;

- h) the amount 'Te' along with the applicable interest shall, during every tax period of the useful life of the concerned capital goods, be added to the output tax liability of the person making such claim of credit.

- 2) The amount 'Te' shall be computed separately for central tax, State tax, Union territory tax and integrated tax.

Explanation: -For the purposes of rule 42 and this rule, it is hereby clarified that the aggregate value of exempt supplies shall exclude: -

- a) *the value of supply of services specified in the notification of the Government of India in the Ministry of Finance, Department of Revenue No. 42/2017-Integrated Tax (Rate), dated the 27th October, 2017 published in the Gazette of India, Extraordinary, Part II, Section 3, Sub-section (i), vide number GSR 1338(E) dated the 27th October, 2017;*
- b) *the value of services by way of accepting deposits, extending loans or advances in so far as the consideration is represented by way of interest or discount, except in case of a banking company or a financial institution including a non-banking financial company, engaged in supplying services by way of accepting deposits, extending loans or advances; and*
- c) *the value of supply of services by way of transportation of goods by a vessel from the customs station of clearance in India to a place outside India.*

Relevant circulars, notifications, clarifications issued by Government

- Chapter Nineteen of the compilation of the GST Flyers as issued by the CBIC on 'Input Tax Credit Mechanism in GST'

Related Provisions of the CGST Statute

Section or Rule	Description
Section 2(47)	Definition of 'Exempt Supply'
Section 2(119)	Definition of 'Works Contract'
Section 16	Eligibility and conditions for taking input tax credit
Section 18	Availability of credit in special circumstances
Section 74	Determination of tax not paid or short paid or erroneously refunded or input tax credit wrongly availed or utilised by reason of fraud or any wilful misstatement or suppression of facts.
Section 129	Detention, seizure and release of goods and conveyances in transit
Section 130	Confiscation of goods or conveyances and levy of penalty
Schedule II	Activities to be treated as supply of goods or supply of services
Rule 45	Conditions and restrictions in respect of inputs and capital goods sent to the job worker
Section 16 of IGST Act	Zero Rated Supply

17.1 Introduction

The input tax credit eligibility is based on the fact as to whether the goods or services or both are used for taxable supplies or exempt supplies. Where the goods or service or both are used for both taxable and exempted supplies, only proportionate credit is allowed to a registered person, Further, this section provides for a list of supplies that are ineligible for input tax credit.

17.2 Analysis

(a) Proportionate credit:

ITC based on usage in business

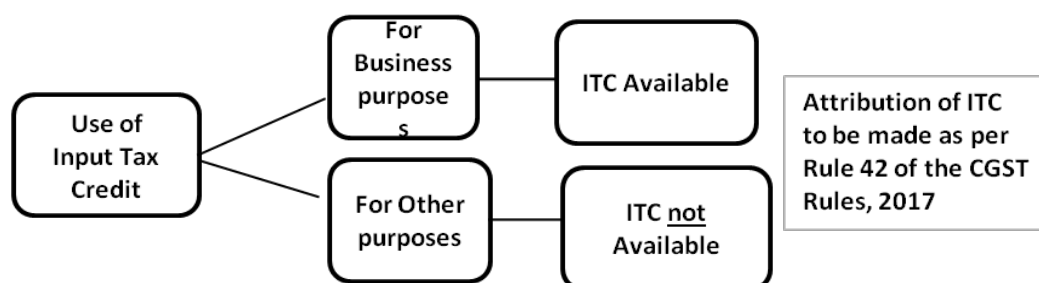

ITC based on use of Inputs

ITC on the Basis of use of Inputs

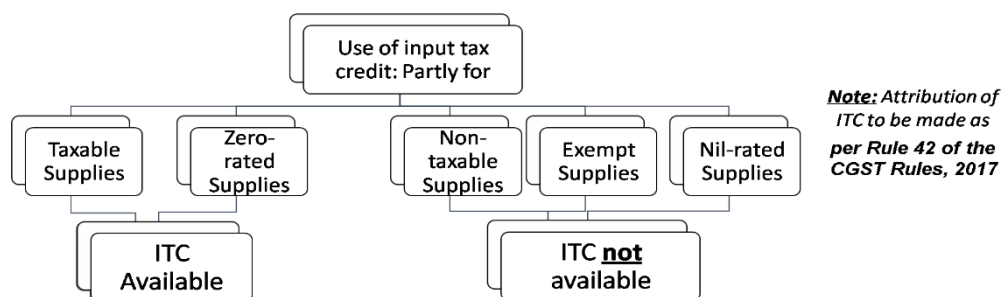

Alternative to apportionment between taxable & exempt supplies in case of **banking companies & financial institutions**:

- **Yearly option** to avail a standard rate of 50% of eligible ITC on inputs, capital goods and input services on a **monthly basis**

(b) **Definition of 'exempt supply'**: It is very interesting to note that although an exempt supply is defined in section 2(47), section 17(3) read with explanation (2) in rule 45 for purposes of input tax credit reversal includes the following transactions as well:

- tax paid under reverse charge,
- transaction in securities,

- sale of land and sale of building subject to clause (b) of Paragraph 5 of Schedule II.

Thus, in a way, exempt supply for the purpose of section 17(3) means all such transactions that come within the sweep and ambit of section 2(47) and such other transactions listed in section 17(3) – is this permissible under law ?

Please note that the value of supplies in respect of which the outward supplier is not liable to pay tax but the recipient is made liable to pay tax under Sections 9(3) and 5(3) of the CGST and IGST Act respectively, would be regarded as 'exempt supplies' for the limited purpose of determining net available input tax credit. Doubts have been raised whether such supplies should be included as exempt supplies by the recipient who pays the tax under reverse charge. In this context, it would be relevant to note that Section 17(3) identifies supplies attracting reverse charge to be an exempt supply in the hands of the supplier effecting such supplies and not in the hands of the recipient who avails such services liable under reverse charge.

Explanation added to Section 17(3) is an important amendment to allow assessee to avail full credit even if they are not paying GST if the activities or transactions are mentioned in Schedule III except sale of land and completed building.

For Eg. Sale of goods on high seas or merchant trading transactions will not entail any reversal of input tax credit as they have now been covered under Schedule III after the amendment.

CGST Amendment Act, 2018

An explanation has been added to Section 17(3) to provide that value of exempt supplies shall not include transactions listed under Schedule III (Transactions which are treated "neither as a supply of goods nor a supply of services") except sale of Land and Completed Building. Thus, no credit would be required to be reversed for engaging in transactions referred under Section Schedule III though no GST is paid on such transactions.

The above explanation will also cover two new entries which have been added to the said Schedule – Supply of Warehoused Goods before clearance for home consumption and Supply of Goods from one non-taxable territory to another without the goods entering India. No reversal of credit would be required for engaging in these transactions.

- (c) **Banking Company or financial institution including NBFC engaged in accepting deposits, extending loans or advances:** An option is made available to a Banking company or financial institution including NBFC engaged in accepting deposits, extending loans or advances that chooses not to comply with the provisions of sub-section (2) of section 17:

- (i) Refrain from availing input tax credit relating to 'non-business purposes' and those restricted u/s 17(5) – This needs to be reported in FORM-GSTR 2
- (ii) Avail full credit on inter-branch supply of services between distinct persons of the banking or NBFC company; and
- (iii) Avail 50% of 'all other' input tax credits. 'All other' credits refer to eligible input tax credit that would have been available u/s 16 before administering the restriction in this section.

(d) Ineligible Input Tax Credit – Input Tax Credit will not be available in respect of the following

This section commences with a non obstante clause "notwithstanding anything contained in sub section (1) of section 16 and sub section (1) of section 18". It clearly means that the provisions of section 17(5) overrides sections 16(1) and 18(1). Not satisfied with this restriction, the legislature uses the expression 'in respect of' appearing in section 17(5) which connotes a narrower meaning akin to "only".

Consider an illustration where input 'A' is converted into output 'B' (both being goods) and a certain quantity of output 'B' that are produced but not yet supplied are destroyed by fire. Now, is GST payable on output 'B' or is it sufficient, if input tax credit taken on input 'A' is reversed?. Destruction of a part of output 'B' does not satisfy the requirements of 'supply' and therefore, there is no question of payment of tax on the output that are destroyed by fire before they are supplied. This would have been the case under Central Excise law (as Central Excise Duty was payable on manufacture) but those principles do not find place in GST law. Under the GST laws, on destruction of output 'B', the only tax that remains to be paid is the proportionate credit availed on input 'A'. Recovery of input credit that was properly availed on 'A' used in the course or furtherance of business in the production of 'B' which was subsequently destroyed before being supplied renders the credit availed to fail the requirements of section 16(1). Credit is not an entitlement at the time of receipt of inputs but an entitlement on the condition of its participation in a taxable outward supply. It must be added here that, there is no question of reversal of input tax credit under clause (h) in respect of inputs forming part of normal (or even abnormal) wastage in the course of production of the output. Credit 'in respect of' inputs that fail to participate in a taxable outward supply are identified and recovered by this clause. Therefore, by this illustration, it becomes clear that the words 'in respect of' are not limited to the very articles that are disqualified from claim of input tax credit under this subsection but also credits 'in respect of' goods or services linked to the disqualified articles are also liable to be disqualified. The analysis of above provision in a pictorial form is summarised as follows:

Restrictions on ITC: Blocked credits under Sec 17(5)**(a) Motor Vehicles**

Note: Further, to come out of the restriction applicable to motor vehicles 'claiming' them to be for transportation of goods or transportation of passengers, registrations necessary under the motor vehicles' registration laws must also be in alignment with such a 'claim'. It would not suffice to merely claim motor vehicles which are duly registered for 'private use' to be used for transportation of goods or transportation of passengers. It may be a fact that a motor vehicle registered for private use, is in fact, used often for transportation of goods or transportation of passengers, it would still not escape the restriction because of the primary purpose of such a motor vehicle reported at the time of its registration.

Also note that rent-a-cab is a term that has been defined in Motor Vehicles Rules, 1989 and motor cab is defined in section 2(25) of the Motor Vehicles Act, 1988 to be limited to vehicles designed to transport 'less than 6' persons. Service tax law, however, expanded the meaning of 'cab' while imposing tax under the category of Rent-a-Cab Operator Services to include vehicles designed to seat more than 12 persons. In this section, rent-a-cab is not defined and it must be admitted to be an expression not of common usage. Now, the question arises as to whether the expansive meaning from the (now repealed) Finance Act, 1994 is to be borrowed or the meaning (now valid) Motor Vehicles Act/Rules is to be considered. It is a settled position of law that current law, would prevail over repealed law. As such, it would be limited to motor cabs designed to carry 'less than 6 persons'. Thus, input tax credit in respect of transport of persons in a bus or minivan (for more than 6 persons) would not be blocked and the restriction shall apply only in respect of cars used as cabs.

It would also be relevant to note that for availment of credit on motor vehicles used for transport of passengers, the vehicle should be used for making taxable outward supplies. On the other hand, credit on motor vehicles used for transport of goods, does not require taxable outward supplies to be effected. Hence, a company using a motor vehicle for site visit purposes may not be eligible to avail credit on such motor vehicle but a Company using a motor vehicle to transport goods from their warehouse to factory / site or from factory to customer location would be entitled to claim credit of taxes paid on such motor vehicle.

After effective date Clause (b) of Section 9 of CGST Amendment Act, 2018 replaces clause (a) of Section 17(5) regarding eligibility/ non-eligibility of input tax credit on vehicles is more specific. As per amended provisions, motor vehicles for transportation of persons having approved seating capacity of not more than thirteen person 13 persons (including the driver) are excluded from eligible input tax credit except motor vehicles are), Vessel and Aircraft if used for following specified purpose.:

- (a) Further supply of such vehicle or vessel or aircraft or
- (b) Transportation of passengers or
- (c) Imparting training on driving, flying, navigating, such vehicles or

- (d) Imparting training on navigating such vessels or
- (e) Imparting training on flying such aircraft

As per the amended provisions, ITC on motor vehicles with approved capacity of more than 13 persons (including the driver) shall be available. Further, credit of general insurance, servicing, repair and maintenance shall be available so far as it relates to motor vehicle, vessels or aircraft on which credit is available. Further, credit will also be available if the services are received by a taxable person engaged in manufacture of the motor vehicles or in supply of general insurance services in respect of motor vehicles, vessels or aircraft insured by him.

(b) Supply of goods and services being:

In the certain specified cases, credit is blocked unless they are used in making a further outward supply as such or as an element of a composite or mixed supply.

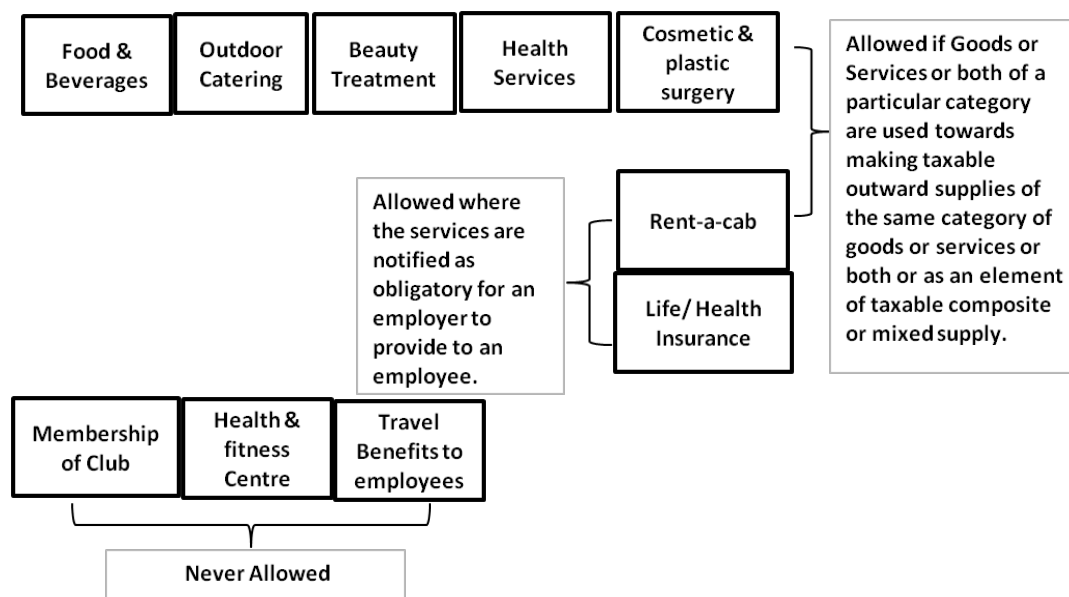

As per amended section 17(5), input tax credit of all above services shall be eligible if it is obligatory on the part of employer to provide the same to its employees under any law for the time being in force. For Eg Credit of GST paid on outdoor catering services used in factory may be allowed after effective date, as Factories Act made it compulsory to provide canteen services if factory has certain no of employees. Earlier, this credit was not allowed.

Note: Though credit is restricted in respect of the above supplies, credit would still be allowed if they are used for effecting further taxable supply of the same category; or as an element of a taxable composite or mixed supply. Often in a business scenario, it is extremely difficult to link up such inward supplies to taxable outward supplies. For instance – in a rent-a-cab

service – input tax credit would be allowed if the corresponding inward supply could be linked to an outward supply of the very same rent-a-cab service; but if rent-a-cab outward supply is provided free of cost then the question that arises is – whether input tax needs restriction or output supply is subject to valuation? Assume that in the very same example the rent-a-cab outward supply is provided by a hotel to its guest – say free drop to airport – what would be the position of input taxes ? The pertinent question would be whether it was for furtherance of business for which the obvious answer would be in affirmative as in business nothing is done for charity and the cost would have been included in the value of the other service or goods. Alternative views may arise due to the facility not being uniformly available to all guests. Readers are free to frame their views considering the circumstances.

It would not suffice to merely claim that these restricted supplies are used for further taxable supply in the absence of a clear link between the restricted inward supply and the taxable outward supply. Mere utilization of these restricted supplies for the benefit of the supplier in the course of an outward supply may validate availment of input tax credit on such restricted supplies.

Certain instances where the credits on aforementioned restricted categories can be attempted to be availed

Inward Supplies	Credit Eligibility
Food & Beverages or Outdoor Catering	<p>Corporate party organized by hiring an Event Manager. Event Manager is contracted to ensure all arrangements relating to food, guests, lighting, decoration, cab services for pick up and drop etc</p> <p>Event Manager uses the services of a caterer to serve food at the party and engages a rent-a-cab operator to pick-up and drop guests.</p> <p>(i) Credit to Event Manager for food and Rent-a-Cab services – Available since inward supplies have been used for making outward supplies</p> <p>(ii) Credit to Company – Available since they are availing composite supply of event management and not a standalone supply of various elements contained in organizing such event</p>
Renting or hiring of motor vehicles provided to Company for transport of female employees who work on night shift	Karnataka Shops and Establishment Regulations mandates every employer to ensure that cab facility is provided to female employees working during night shift. Any cab facility provided for transport of female employees is mandated by statute and credit of the same would be available to the employer.

Travel Benefits to Directors	Travel Benefits to employees have been specifically restricted from credit availment but nothing has been mentioned about the travel benefits extended to non-executive directors and hence the same should be available. Credits on transactions for “non business use” may not apply here since Company is accounting this as a business expenditure in their books of accounts.
------------------------------	--

Clause (b) of Section 9 of CGST Amendment Act, 2018 replaces clause (b) of Section 17(5) to bring out the following amendments:

1. Credit shall not be available for the supply of food and beverages, outdoor catering, beauty treatment, health services, cosmetic and plastic surgery, leasing, renting or hiring of motor vehicles, vessels or aircraft referred to in clause (a) or clause (aa) of Section 17(5) except when used for the purposes specified therein. In other words, renting or hiring of motor vehicles, vessels and aircraft are blocked only if the purchase of such motor vehicles, vehicles and aircrafts are blocked as per clause (a) of (aa). However, input tax credit in respect of such goods or services or both shall be available where an inward supply of such goods or services or both is used by a registered person for making an outward taxable supply of the same category of goods or services or both or as an element of a taxable composite or mixed supply.
2. Further, credit in respect of life insurance and health insurance will continue to be blocked.
3. ITC on membership of club, health and fitness centre will also be considered as blocked
4. Further, travel benefits extended to employees on vacation such as leave or home travel concession will also not be available.
5. The provisions have been amended so as to allow ITC in respect of goods or services or both specified above if it is made obligatory for an employer to provide such services under any law for the time being in force.
6. In all the above cases, the credit will be available if the goods or services are required to be provided by the employer through any obligation imposed under any law

Where steps are taken to include these inward supplies as an ‘element’ of an outward supply, then credit cannot be denied.

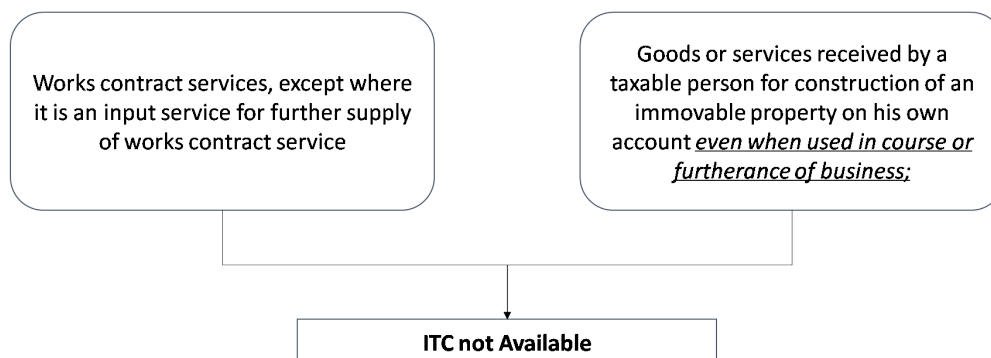
(c) Construction of Immovable Property (other than plant & machinery)

“Construction” includes re-construction, renovation, additions or alterations or repairs, to the extent of capitalization, to the said immovable property. Please note that ‘alterations’ and ‘repairs’ are also included in this definition if capitalized.

Note: Considering that ‘works contract services’ is not classified as a taxable outward supply in itself, the restriction would apply only in such of those cases where the corresponding inward supply of ‘works contract services’ is not used directly in a further taxable outward supply. Input tax credit attributable to ‘Works Contract Services’ (including on inward supply of goods or services) availed by builders / developers for providing outward supply of services, would be eligible for ITC. It is important to note that credit of GST paid on works contract services would be allowed only if the output supply is also works contract services.

In respect of inward supply of works contract resulting in immovable property for own use, the corresponding tax credits would be blocked if it is used “for” construction. Hence, costs directly related to construction would not enjoy any input tax credit, but costs which directly do not relate to construction would be entitled to credit.

Plant and machinery: means apparatus, equipment, machinery fixed to earth by foundation or structural support that are used for making outward supply of goods or services or both and includes such foundation and **structural** supports but excludes land, building or any other civil structures, telecommunication towers; and pipelines laid outside the factory premises. The definition of plant and machinery is also unique in including foundation and support which could be a works contract service for which credit is allowed but excludes ‘any other civil structure’. The intention appears to be put to rest the disputes in the past where foundation and structure which may include civil construction which are part of the plant and machinery would be eligible for credit. Specific exclusion like telecommunication towers may exclude some parts of other than the basic tower. These aspects may also be retested in time to come.

(d) Self-construction

Inward supply of goods or services for construction of an immovable property for ‘own use’ would also not be eligible for input tax credit. This restriction applies even when such

immovable property is used in the course or in furtherance of business. Understanding the scope of 'immovable property' is very important. Immovable property is well understood to be land and building but it also includes everything that is attached to or forming part of the land and rights-in-land. Credit is blocked on all inward supplies leading to the establishment of such immovable property. Inward supply of services from real estate agent, architect, interior decorators and contractors are all blocked as these are involved in the establishment of the immovable property. But, if inward supplies such as security, house-keeping and property maintenance are used after construction, then such credits are not blocked as these are received after establishment of the immovable property. One needs to note the fine line that the law draws to prevent indiscriminate extension of this credit blockage beyond the purpose for which it is specified.

Factors to be considered for deciding whether the credits on costs associated with works contract or construction of immovable property are available or not

- (i) If rent charged separately for bare shell and the fitouts – No Credit in respect of inputs used in construction of bare shell whereas credits could be available on fitouts related material;
- (ii) Accounting treatment in the books – Are the costs capitalized with the Building or separately disclosed in the fixed asset register? Separate capitalization – Credit would be available;
- (iii) Things which cannot be retrieved without damage to the goods – Immovable and hence no credit;
- (iv) HSN Code in the Bill – If classified under the category of construction – Then credit is may not be available. There is a settled principle of law that incorrect classification by the supplier should not lead to denial if in normal circumstances it would be eligible;
- (v) Separate PO and Invoice from the vendor to bifurcate between transactions on which one would avail credits and on transactions on which one would not avail credits;
- (vi) Accounting of transactions and assigning the Project / Cost Code.

Please note that every structure is not immovable property. Please examine if the structure is a 'means of production' or the 'location of production'. Steel structures for gantry crane to move about would not be building but part of the supports for the crane. This area requires some technical insight and cannot be dismissed based on visual inspection by an untrained eye.

(e) Not used in business

Since credit reversal is required whenever inputs are lost, stolen or destroyed, distinction is to be made between inputs 'lost' and 'loss' of inputs. As stated earlier, credit is not liable to be reversed in case of 'loss' of inputs that do not amount to inputs being 'lost'. The loss could be either normal or abnormal (as per industry standards). Reversal of credit is occasioned when there is any event that results in inputs being 'lost'.

Stocks given away as gifts or free samples appear to be covered by this clause (h), but it is important to note that the manner of giving away gifts or free samples is qualified with the word 'disposal'. Disposal has already been used once before in section 7(1)(a) which is not the same as 'sale' or 'transfer'. Therefore, it appears that gift or free samples given must be such that they are not by way of 'sale' or 'transfer' (or any other form of supply). From our earlier discussion, undervaluation of stocks given away for non-monetary consideration was concluded to be a taxable supply. Here 'disposal' by way of gift or free samples must necessarily be stocks 'not meant for supply' that are to be distributed for non-monetary consideration. Some examples of goods 'not meant for supply' are as follows:

- Prescription drug samples marked 'Physician's sample not to be sold'
- As per the Legal Metrology (Packaged Commodity) Rules, 2011 sale of packaged commodities by a manufacturer, importer or wholesale dealer to an Industrial consumer shall have the declaration 'Not for retail sale'.

It is also important to understand that a supply that is rightly taxable cannot be substituted based on its being given away as gift or free samples by mere reversal of relatable input tax credit. Meaning to say, prescription drugs supplied across the counter free of cost cannot be classified as 'free sample' merely because it is supplied for free. The supplier of such goods cannot exempt himself from payment of tax on such goods by claiming to have reversed input tax credit proportionate to goods supplied for free. It is only when stocks that are 'not meant for sale' for supply are 'disposed off', the words 'in respect of' manages to recover input tax credit relatable to the inputs used in the production of such stocks that no longer make a taxable supply.

Some experts argue that nothing done in business is free and therefore reversal of ITC would be sufficient as it is in course and furtherance of business. This matter may also be tested in time to come.

CGST Amendment Act, 2018

Multiple amendments have been made to Section 17(5) of the CGST Act. The implications of the same have been provided below

1. Credits relating to motor vehicles (MV)

Category of Service	MV with seating capacity of 14 or more	MV with seating capacity or 13 or less*	
		For Re-sale, Transport by Transport Operator, Driving School	Other Use
Credit on MV	Available	Available	Not Available
Credit on repair,	Available	Available	Not

insurance, servicing etc			Available
Credit on Renting, Leasing or Hiring	Available	Available	Not Available

* Similar conditions prescribed for Aircraft and Vessel. Additionally, Aircraft and Vessel used for transport of goods will also be eligible purchases for credit availment

2. The Current law disallows credit on Motor Vehicle and other conveyances which can include two wheelers. However, the amended provisions refers to disallowance of credit only in case of Motor Vehicles. Section 2(17) of the Motor Vehicles Act, 1939 defines the term Motor Cycle to mean “two-wheeled motor vehicle” and Section 2(18) of the said Act defines Motor Vehicle to exclude “vehicle having less than four wheels”. Based on the above, we can observe that Motor Vehicles do not include Motor Cycles / Two wheelers and hence credit of the will be available under the Amendment Act.
3. Other employee benefit related entries have been merged and continue restriction of credit on the same unless they are used for providing output services or have been provided based on an obligation arising out of any law. For all the entries in clause (b) of Section 17(5), the input tax credit will be available in respect of goods or services where it is obligatory for an employer to provide the same to its employees under any law.

(f) Reversal of Input tax credit - Computation of Exempt Turnover and Total Turnover in the State

Rule 42 requires common credits used for taxable and exempt supplies to be availed in the same proportion as that of the taxable supplies to the Total Turnover in the State.

Total Turnover in the State means

- (i) Value of all taxable supplies (other than inward supplies covered under reverse charge) made within the State
- (ii) Value of all exempt supplies made within the State
- (iii) Exports
- (iv) Inter State Supplies

but excludes CGST, SGST, IGST and Compensation Cess.

Exempt Turnover means

Supply of any goods or services or both

- (i) which attracts nil rate of tax or

- (ii) which may be wholly exempt from tax under section 11, or under section 6 of the Integrated Goods and Services Tax Act, 2017

and includes

- (i) non-taxable supply – Supplies not leviable to tax under GST. Eg: Alcohol
- (ii) supplies on which the recipient is liable to pay tax on reverse charge basis – it would be treated as exempt in the hands of the supplier and not recipient. Eg: Sponsorship Services by Educational Institution would be treated as exempt supplies in the hands of educational institution since it attracts GST under reverse charge;
- (iii) Transaction in securities – Value shall be 1% of the sale value;
- (iv) Sale of Land – Value shall be the same as adopted for stamp duty purposes;
- (v) Sale of Completed Building on which GST is not applicable (sale after receipt of occupancy certificate or after first occupation) – Value shall be the same as adopted for stamp duty purposes.

but excludes

- (i) Excise Duty levied under Entry 84 of List 1 of the Seventh Schedule to the Constitution of India [applicable on petroleum crude, high speed diesel, motor spirit (commonly known as petrol), natural gas aviation turbine fuel and tobacco and tobacco products];
- (ii) Excise Duty levied under Entry 51 of List 2 of the Seventh Schedule to the Constitution of India [applicable on alcoholic liquor for human consumption and opium, Indian Hemp and other Narcotic drugs and narcotics];
- (iii) VAT on sale of goods under Entry 54 of List 2 of the Seventh Schedule to the Constitution of India [applicable on petroleum crude, high speed diesel, motor spirit (commonly known as petrol), natural gas aviation turbine fuel and tobacco and tobacco products];
[Explanation to Rule 43 – Amendment effective from January 25, 2018]
- (iv) Supply of Services to Nepal and Bhutan against Indian Rupee covered under Notification No.42/2017 – IGST (Rate) dated 27.10.2017 [Explanation to Rule 43]
- (v) Interest / Discount received on deposits, loans etc (except for Banks and other Financial Institutions) [Explanation to Rule 43]
- (vi) Services by Transport of Goods by vessel from customs station to place outside India [Explanation to Rule 43]

Exemption from GST was provided on services of transport of goods by vessel / aircraft from customs station to place outside India but only transport of vessel is excluded from definition of exempt supplies and hence input tax credit would have to reversed on transport of goods by aircraft.

The value of activities or transactions specified in Schedule III other than sale of land and subject to clause (b) of Paragraph 5 of Schedule III, sale of building. This provision is yet to be notified. Thereby, the following supplies will not be categorized as exempt supplies for the purpose of reversal even though they may be considered as activities or transactions which are considered as neither supply of goods nor supply of services:

1. Services by an employee to the employer in the course of or in relation to his employment.
2. Services by any court or Tribunal established under any law for the time being in force.
3.
 - (a) the functions performed by the Members of Parliament, Members of State Legislature, Members of Panchayats, Members of Municipalities and Members of other local authorities;
 - (b) the duties performed by any person who holds any post in pursuance of the provisions of the Constitution in that capacity; or
 - (c) the duties performed by any person as a Chairperson or a Member or a Director in a body established by the Central Government or a State Government or local authority and who is not deemed as an employee before the commencement of this clause.
4. Services of funeral, burial, crematorium or mortuary including transportation of the deceased.
5. Actionable claims, other than lottery, betting and gambling.
6. Supply of goods from a place in the non-taxable territory to another place in the non-taxable territory without such goods entering into India.
7.
 - (a) Supply of warehoused goods to any person before clearance for home consumption;
 - (b) Supply of goods by the consignee to any other person, by endorsement of documents of title to the goods, after the goods have been dispatched from the port of origin located outside India but before clearance for home consumption.”

It is pertinent to highlight high sea sales and merchant trading sales as mentioned in point (6) and (7) above in the above list of activities or transactions. Both these transactions were opined to be non taxable supply before the amendment. Since, non-taxable supplies are covered within the definition of exempt supplies the aforesaid transactions would also have been classified within exempt supplies. As a result they would have entailed reversal of input tax credit before the amendment. However, after the amendment has been notified, they are mandatorily out of the purview of exempt supply for the purpose of reversal. Thereby any input tax credit attributable to these transactions will not be considered for the purpose of reversal.

On completion of the financial year, input tax credit shall be determined accurately based on actuals, in the same manner as provided in Rule 42. A 'true up' is required to be done on an annual basis (between the amounts reversed for each tax period during the year and the

amount determined at the end of the financial year) and any excess credit availed needs to be reversed with interest while short credit, if any, needs to be re-availed within 6 months from end of the financial year.

(g) Goods or services or both on which tax has been paid under Section 10

Section 10 depicts the conditions to be fulfilled for a person falling under composition scheme. One of the conditions state that a person opting for the composition scheme should not collect any taxes from the recipient. As no taxes are paid by the recipient, no input tax credit can be availed by them either. This clause within Section 17(5) casts the restriction upon the recipient to not avail any input tax credit for taxes paid under composition scheme.

(h) Goods or services or both received by a non resident taxable person except on goods imported by him

A non resident taxable person is a person who temporarily supplies any goods or services within India even though they are not a resident of the taxable territory. For these persons, a restriction has been cast in respect of the goods or services received within India. In respect of the goods or services received within India, no input tax credit can be availed by them. However, they are free to avail the input tax credit of the goods imported by them from outside India.

(i) Goods lost, stolen, destroyed, written off or disposed of by way of gift or free samples

When any goods are bought, input tax credit on it may be eligible. However, if the goods are treated in any one of the ways given above, then the input tax credit availed may have to be reversed. Ofcourse, if the goods are purchased with the intent of using it for any of the aforesaid purposes, then input tax credit may not be availed in the first place.

It may be noted here that all the above ways stated in respect of goods are exhaustive. Any goods which are treated in any other manner will not be restricted from input tax credit. Any inward supplies in respect of goods which are used for business promotion or exhibition may not attract any of the restrictive words given above. Thereby, input tax credit in respect of those may be considered as available. A short description of each of the words given above are depicted below:

- a. Lost – This can include goods getting lost as part of process loss due to any abnormal dysfunction. Ideally normal losses should not entail any reversal of input tax credit.
- b. Stolen – When any goods are found to be lower upon physical verification, it may be considered as stolen. This will require reversal of any input tax credit taken earlier
- c. Destroyed – Any goods which get destructed due to any natural calamity like flood, earthquake or a man made event like fire, water leakage etc. However, if the goods reach to a certain level of destruction that it cannot be possibly reversed, then this clause gets attracted.
- d. Written off – If any goods are having a certain value as per the books of accounts but

are completely written off due to any reason, this clause will get attracted. This can include goods getting written off due to obsolescence or lapse of time.

- e. Disposed off by way of gift or free samples – Any goods which are disposed through these two mechanisms will be covered here. Ideally gift is given out of natural love and affection and does not involve any business motive (at least not clearly evident). For instance, a shirt manufacturer giving his relative his brand of shirt during any occasion will be covered here.

The second instance of disposal covered here can be free samples. Any goods which are disposed as a free sample to enthruse the buyer to buy more in future can be covered here. The input tax credit on such goods are considered to be blocked by Section 17(5)(h). It may be noted that the free sample should only be in respect of the goods getting marketed. If lets us say a calendar, diary etc. is given a manufacturer to their dealers as part of brand promotion, the same will not be covered here. Ideally, input tax credit on this should be allowed on these goods assuming the manufacturer is not dealing in them.

Implications under GST in case of Expired Medicines

In case of Pharmaceutical Industry, the medicines carry expired date and it is the duty of the manufacturer to destroy the unsold medicines on the date of expiry. Accordingly, the manufacturer collects such unsold expired medicines from various levels in the supply chain and destroys the expired medicine based on the provisions of the Drugs and Cosmetics Act, 1940. It would be relevant to note that the manufacturer compensates the supply chain for loss due to expired medicine. Circular 72/2018 has been issued to highlight the implications under GST on such expired medicine. These implications have been discussed below by way of an example

Assumption

- Medicine purchased / imported at Rs 100 and GST paid Rs 5
- Medicine sold to Distributor at Rs 200 and GST charged Rs 10

Scenario	Clarification Issued – Options	Implications
Original Sale 2017-18 (till March 31, 2018) Expired Stock Returned By September 30, 2018	<u>Option 1</u> 1. Seller to issue credit note to Distributor for Rs 100 + 10 2. Distributor to reverse credit of Rs 10 3. Seller to reverse credit of Rs 5 (GST paid on procurement)	Seller to receive expired stock under credit note route (option 1) and thereby restrict credit reversal to the tax paid on procurement
	<u>Option 2</u> 1. Distributor to issue Invoice	

	<p>for Rs 100 + 10</p> <ol style="list-style-type: none"> 2. Seller to avail credit of the same 3. On destruction of goods, Seller to reverse credit of Rs 10 (GST paid on sales) 	
<p>Original Sale 2017-18 (till March 31, 2018)</p> <p>Expired Stock Returned after September 30, 2018</p>	<p>Option 1</p> <ol style="list-style-type: none"> 1. Seller to issue credit note to Distributor for Rs 100 + Rs 0 2. No implications on distributor and credit availed by them on original supply may not be questioned as per the clarification of the Circular which provides that credit notes can be issued even after 6 months from the end of the FY but from the perspective of the distributor, he has availed credit on stocks against which he does not have a corresponding output and hence issues on credit eligibility in the hands of distributor may arise. Hence, distributor can ask for compensation of Rs 10 credit lost by him 3. Seller to reverse credit of Rs 5 (GST paid on procurement) <p>Option 2</p> <ol style="list-style-type: none"> 1. Distributor to issue Invoice for Rs 100 + 10 2. Seller to avail credit of the same 3. On destruction of goods, Seller to reverse credit of Rs 10 (GST paid on sales) 	<p>Option 1 leads to reversal of credit of Rs 15 whereas Option 2 leads to reversal of credit of Rs 10.</p> <p>Effectively, the manufacturer is required to reverse credit on the selling price which can be substantial amount.</p> <p>This needs to be examined specifically in terms of Section 18 of Drugs and Cosmetics Act, 1940 which prohibits sale of Expired Stock</p>

* It is a wonder how 'expired medicines' can at all enjoy same HSN and 'medicines'. Surely, something has occurred that brings about this categorization as 'expired'. And when HSN cannot remain the same, inquiry is required into what is the 'object of supply'. Is it some other goods or when it is not any kind of goods, is it therefore a service (in GST terms)?

(j) Any taxes paid in accordance with the provisions of Sections 74, 129 and 130

Section 74 talks about payment of taxes in a situation where taxes is not paid or short paid or erroneously refunded or input tax credit wrongly availed or utilized by reason of fraud or willful misstatement or suppression of facts. If the supplier is making payment of taxes under forward charge due to the aforesaid reasons, no input tax credit will be available to the recipient. In case of reverse charge, if the recipient is making payment of taxes under this section, even the recipient will not be allowed to avail input tax credit.

Section 129 talks about detention, seizure and release of goods and conveyance in transit. Further, Section 130 mentions about confiscation of goods and/or conveyance and levy of penalty. In both the cases if any payment is made by any person under these sections, no input tax credit in respect of these will be available.

Through this point, input tax credit is proposed to be blocked wherever mens rea is proven/accepted. In such cases, since taxes had not been paid earlier due to any fraudulent intent, no input tax credit is allowed by the law.

17.3 Issues and Concerns

- (i) Sub-Sections (c) and (d) of Section 17(5) restricts input tax credit when received towards construction of immovable property. The term 'construction' used in Section 17 has been explained to includes re-construction, renovation, additions or alterations or repairs to an immovable property only to the extent it has been capitalised in the books of accounts. Would this mean that any renovation, additions or alterations or repairs to an immovable property which is not capitalised would still be an eligible input tax credit as long as it fulfils the conditions in Section 16 of the Act. For example, a service provider replaces broken windows in his office, the cost of which has not been capitalised in its books of accounts, instead the entire amount has been charged to the profit and loss account along with taxes. Would the company still be eligible to avail input tax credit since there is no restriction on availing the said tax credits either under Section 17(5) or under Section 16(3).
- (ii) Now the question arises as to whether input tax credit incurred on special purpose motor vehicles such as cranes, drilling and excavation vehicles such as bore well drilling lorries and bulldozers which cannot be claimed to be used in transportation of goods. Section 17(5) restricts input tax credit on Motor vehicles and other conveyances unless the same has been used in the transportation of goods or for effecting taxable supplies such as further supply of the motor vehicle, transportation of passengers or imparting training for driving such vehicles. The GST Act borrows the definition of a motor vehicle from section 2(28) of the Motor Vehicles Act, 1988 which is defined as "*any mechanically propelled vehicle adapted for use upon roads whether the power of propulsion is transmitted thereto from an external or internal source and includes a*

chassis to which a body has not been attached and a trailer; but does not include a vehicle running upon fixed rails or a vehicle of a special type adapted for use only in a factory or in any other enclosed premises or a vehicle having less than four wheels fitted with engine capacity of not exceeding thirty-five cubic centimeters;” In view of the above definition, a crane, borewell or a bulldozer can be said to be a motor vehicle. In the past cenvat regime where similar restriction existed, the credit was allowed. This aspect may be tested in time to come.

- (iii) The credit which is not specifically attributable to exempt or taxable supplies would be treated as common credit and would be subject to reversal of credits in the proportion of exempt supplies over total supplies. There could be circumstances where the credit is not related to an exempt or taxable supply and yet not common for the entire business but only a particular cost centre / project. Eg. XYZ Builders are engaged in construction of residential complexes and sale thereof. Currently, two projects at two different locations in the State of Uttar Pradesh are under execution. Project 1 – OC received and certain improvement cost incurred on which GST has been charged by the vendor. Project 2 – Under Construction. Credits of Projects 1 are not exclusively used for exempt nor exclusively used for taxable purposes. To the extent the credit relates to apartments sold before OC, these are for taxable purposes and to the extent the credit relates to apartments sold after OC, these are for exempt purposes. Since these are not exclusive to taxable or exempt supplies, these would be treated as common credits and their availment would depend on the turnover of the entire company and not merely Project 1. It would be important to note that Rule 6 of the CENVAT Credit Rules, 2004 allowed for maintenance of separate records for availment of credit and a tax payer would use this rule to reverse the credit related to Project 1 based on the turnover / area sold after OC of project 1.

17.4 Comparative Review

Aspect	Credit under old regime	Input tax credit under GST regime
Proportionate credit	No explicit distinction made between goods or services used for business and non-business	Specific distinction made between goods or services used for business and non-business
Works contract credit	Restriction to inputs only	Credit allowed when used for further supply of works contract
Credit on inputs used for construction of immovable property	Input or Input Service used for civil construction not eligible.	Restriction to both inputs and input services.
Credit related to works contract and	Plant and machinery not excluded from restriction of	Plant and machinery is excluded from restriction of

construction w.r.t plant and machinery	credit	credit unless depreciation has been claimed on the tax component.
--	--------	---

17.5 FAQs

Q1. Where goods or services or both received, is used for both taxable and non-taxable supplies, what would be the input tax credit entitlement for the registered person?

Ans. The input tax credit of goods or service or both used in respect of taxable supplies can only be availed by the registered person

Q2. Whether the taxable supply would include supplies on which tax is payable by recipient on reverse charge basis?

Ans. No.

17.6 MCQs

Q1. Which of the following is included for computation of taxable supplies for the purpose of availing credit?

- (a) Zero-rated supplies
- (b) Exempt supplies
- (c) Both
- (d) None of the above

Ans. (a) Zero Rated supplies

Statutory Provisions**18. Availability of credit in special circumstances**

- (1) *Subject to such conditions and restrictions as may be prescribed-*
- (a) *A person who has applied for registration under the Act within thirty days from the date on which he becomes liable to registration and has been granted such registration shall, be entitled to take credit of input tax in respect of inputs held in stock and inputs contained in semi-finished or finished goods held in stock on the day immediately preceding the date from which he becomes liable to pay tax under the provisions of this Act.*
 - (b) *A person, who takes registration under sub-section (3) of section 25 shall, be entitled to take credit of input tax in respect of inputs held in stock and inputs contained in semi-finished or finished goods held in stock on the day immediately preceding the date of grant of registration.*
 - (c) *Where any registered person ceases to pay tax under section 10, he shall be entitled to take credit of input tax in respect of inputs held in stock, inputs contained in semi-finished or finished goods held in stock and on capital goods on the day immediately*

preceding the date from which he becomes liable to pay tax under section 9

Provided that the credit on capital goods shall be reduced by such percentage points as may be prescribed

- (d) *Where an exempt supply of goods or services or both by a registered person becomes a taxable supply, such person shall be entitled to take credit of input tax in respect of inputs held in stock and inputs contained in semi-finished or finished goods held in stock relating to such exempt supply and on capital goods exclusively used for such exempt supply on the day immediately preceding the date from which such supply becomes taxable:*

Provided that the credit on capital goods shall be reduced by such percentage points as may be prescribed

- (2) *A registered person shall not be entitled to take input tax credit under sub-section (1), in respect of any supply of goods or services or both to him after the expiry of one year from the date of issue of tax invoice relating to such supply.*
- (3) *Where there is a change in the constitution of a registered person on account of sale, merger, demerger, amalgamation, lease or transfer of the business with the specific provision for transfer of liabilities, the said registered person shall be allowed to transfer the input tax credit which remains unutilized in his electronic credit ledger to such sold, merged, demerged, amalgamated, leased or transferred business in such manner as may be prescribed.*
- (4) *Where any registered person who has availed of input tax credit opts to pay tax under section 10 or, where the goods or services or both supplied by him become wholly exempt, he shall pay an amount, by way of debit in the electronic credit ledger or electronic cash ledger, equivalent to the credit of input tax in respect of inputs held in stock and inputs contained in semi-finished or finished goods held in stock and on capital goods, reduced by such percentage points as may be prescribed, on the day immediately preceding the date of exercising such option or, as the case may be, the date of such exemption:*
- Provided that after payment of such amount, the balance of input tax credit, if any, lying in his electronic credit ledger shall lapse.*
- (5) *The amount of credit under sub-section (1) and the amount payable under sub-section (4) shall be calculated in such manner as may be prescribed*
- (6) *In case of supply of capital goods or plant and machinery, on which input tax credit has been taken, the registered person shall pay an amount equal to the input tax credit taken on the said capital goods or plant and machinery reduced by such percentage points as may be prescribed or the tax on the transaction value of such capital goods or plant and machinery determined under section 15, whichever is higher:*

Provided that where refractory bricks, moulds and dies, jigs and fixtures are supplied as scrap, the taxable person may pay tax on the transaction value of such goods determined under section 15.

Extract of the CGST Rules, 2017**40. Manner of claiming credit in special circumstances.**

(1) *The input tax credit claimed in accordance with the provisions of sub-section (1) of section 18 on the inputs held in stock or inputs contained in semi-finished or finished goods held in stock, or the credit claimed on capital goods in accordance with the provisions of clauses (c) and (d) of the said sub-section, shall be subject to the following conditions, namely, -*

- a) *the input tax credit on capital goods, in terms of clauses (c) and (d) of sub-section (1) of section 18, shall be claimed after reducing the tax paid on such capital goods by five percentage points per quarter of a year or part thereof from the date of the invoice or such other documents on which the capital goods were received by the taxable person.*
- b) *the registered person shall within a period of thirty days from the date of becoming eligible to avail the input tax credit under sub-section (1) of section 18, or within such further period as may be extended by the Commissioner by a notification in this behalf, shall make a declaration, electronically, on the common portal in FORM **GST ITC-01** to the effect that he is eligible to avail the input tax credit as aforesaid:*

Provided that any extension of the time limit notified by the Commissioner of State tax or the Commissioner of Union territory tax shall be deemed to be notified by the Commissioner.

- c) *the declaration under clause (b) shall clearly specify the details relating to the inputs held in stock or inputs contained in semi-finished or finished goods held in stock, or as the case may be, capital goods—*
 - i. *on the day immediately preceding the date from which he becomes liable to pay tax under the provisions of the Act, in the case of a claim under clause (a) of sub-section (1) of section 18;*
 - ii. *on the day immediately preceding the date of the grant of registration, in the case of a claim under clause (b) of sub-section (1) of section 18;*
 - iii. *on the day immediately preceding the date from which he becomes liable to pay tax under section 9, in the case of a claim under clause (c) of sub-section (1) of section 18;*
 - iv. *on the day immediately preceding the date from which the supplies made by the registered person becomes taxable, in the case of a claim under clause (d) of sub-section (1) of section 18;*

- d) *the details furnished in the declaration under clause (b) shall be duly certified by a practicing chartered accountant or a cost accountant if the aggregate value of the claim because central tax, State tax, Union territory tax and integrated tax exceeds two lakh rupees;*
- e) *the input tax credit claimed in accordance with the provisions of clauses (c) and (d) of sub-section (1) of section 18 shall be verified with the corresponding details furnished by the corresponding supplier in FORM GSTR-1 or in FORM GSTR- 4 , on the common portal.*
- (2) *The amount of credit in the case of supply of capital goods or plant and machinery, for the purposes of sub-section (6) of section 18, shall be calculated by reducing the input tax on the said goods at the rate of five percentage points for every quarter or part thereof from the date of the issue of the invoice for such goods.*

41. Transfer of credit on sale, merger, amalgamation, lease or transfer of a business

- (1) *A registered person shall, in the event of sale, merger, de-merger, amalgamation, lease or transfer or change in the ownership of business for any reason, furnish the details of sale, merger, de-merger, amalgamation, lease or transfer of business, in FORM GST ITC-02, electronically on the common portal along with a request for transfer of unutilized input tax credit lying in his electronic credit ledger to the transferee:*
- Provided that in the case of demerger, the input tax credit shall be apportioned in the ratio of the value of assets of the new units as specified in the demerger scheme.*
- (2) *The transferor shall also submit a copy of a certificate issued by a practicing chartered accountant or cost accountant certifying that the sale, merger, de-merger, amalgamation, lease or transfer of business has been done with a specific provision for the transfer of liabilities.*
- (3) *The transferee shall, on the common portal, accept the details so furnished by the transferor and, upon such acceptance, the un-utilized credit specified in FORM GST ITC02 shall be credited to his electronic credit ledger.*
- (4) *The inputs and capital goods so transferred shall be duly accounted for by the transferee in his books of account.*

41A. Transfer of credit on obtaining separate registration for multiple places of business within a State or Union territory

- 1) *A registered person who has obtained separate registration for multiple places of business in accordance with the provisions of rule 11 and who intends to transfer, either wholly or partly, the unutilised input tax credit lying in his electronic credit ledger to any or all of the newly registered place of business, shall furnish within a period of thirty days from obtaining such separate registrations, the details in FORM GST ITC-02A electronically on the common portal, either directly or through a Facilitation Centre notified in this behalf by the Commissioner:*

Provided that the input tax credit shall be transferred to the newly registered entities in the ratio of the value of assets held by them at the time of registration.

Explanation.- For the purposes of this sub-rule, it is hereby clarified that the 'value of assets' means the value of the entire assets of the business whether or not input tax credit has been availed thereon.

- 2) The newly registered person (transferee) shall, on the common portal, accept the details so furnished by the registered person (transferor) and, upon such acceptance, the unutilised input tax credit specified in FORM GST ITC-02A shall be credited to his electronic credit ledger.

44. Manner of reversal of credit under special circumstances

- 1) *The amount of input tax credit relating to inputs held in stock, inputs contained in semi-finished and finished goods held in stock, and capital goods held in stock shall, for the purposes of sub-section (4) of section 18 or sub-section (5) of section 29, be determined in the following manner, namely,-*
 - a) *for inputs held in stock and inputs contained in semi-finished and finished goods held in stock, the input tax credit shall be calculated proportionately on the basis of the corresponding invoices on which credit had been availed by the registered taxable person on such inputs;*
 - b) *for capital goods held in stock, the input tax credit involved in the remaining useful life in months shall be computed on pro-rata basis, taking the useful life as five years.*

Illustration:

Capital goods have been in use for 4 years, 6 month and 15 days.

The useful remaining life in months= 5 months ignoring a part of the month

Input tax credit taken on such capital goods= C

Input tax credit attributable to remaining useful life= C multiplied by 5/60

- 2) *The amount, as specified in sub-rule (1) shall be determined separately for input tax credit of central tax, State tax, Union territory tax and integrated tax.*
- 3) *Where the tax invoices related to the inputs held in stock are not available, the registered person shall estimate the amount under sub-rule (1) based on the prevailing market price of the goods on the effective date of the occurrence of any of the events specified in subsection (4) of section 18 or, as the case may be, sub-section (5) of section 29.*
- 4) *The amount determined under sub-rule (1) shall form part of the output tax liability of the registered person and the details of the amount shall be furnished in FORM GST ITC03, where such amount relates to any event specified in sub-section (4) of section 18 and in FORM GSTR-10, where such amount relates to the cancellation of registration.*

- 5) *The details furnished in accordance with sub-rule (3) shall be duly certified by a practicing chartered accountant or cost accountant.*
- 6) *The amount of input tax credit for the purposes of sub-section (6) of section 18 relating to capital goods shall be determined in the same manner as specified in clause (b) of sub-rule (1) and the amount shall be determined separately for input tax credit of central tax, State tax, Union territory tax and integrated tax:*
- Provided that where the amount so determined is more than the tax determined on the transaction value of the capital goods, the amount determined shall form part of the output tax liability and the same shall be furnished in FORM GSTR-1.*

44A. Manner of reversal of credit of Additional duty of Customs in respect of Gold dore bar. -

The credit of Central tax in the electronic credit ledger taken in terms of the provisions of section 140 relating to the CENVAT Credit carried forward which had accrued on account of payment of the additional duty of customs levied under sub-section (1) of section 3 of the Customs Tariff Act, 1975 (51 of 1975), paid at the time of importation of gold dore bar, on the stock of gold dore bar held on the 1st day of July, 2017 or contained in gold or gold jewellery held in stock on the 1st day of July, 2017 made out of such imported gold dore bar, shall be restricted to one-sixth of such credit and five-sixth of such credit shall be debited from the electronic credit ledger at the time of supply of such gold dore bar or the gold or the gold jewellery made therefrom and where such supply has already been made, such debit shall be within one week from the date of commencement of these Rules.

Relevant circulars, notifications, clarifications issued by Government:

- Chapter Nineteen of the compilation of the GST Flyers as issued by the CBIC on 'Input Tax Credit Mechanism in GST'

Related Provisions of the Statute

Section or Rule	Description
Section 2(19)	Definition of 'Capital Goods'
Section 2(59)	Definition of 'Inputs'
Section 2(60)	Definition of 'Input Services'
Section 25	Procedure for registration
Section 9	Levy and collection
Section 10	Composition levy
Rule 44	Manner of reversal of credit under special circumstances

18.1 Introduction

Input tax credit is normally available to a registered person who engages in taxable outward supplies and such person not being a composition person. However, in certain cases, credit would be available on inputs held in stock, inputs contained in semi-finished and finished goods and on capital goods even though the supplier was unregistered or engaged in exempt supplies or was under the composition scheme on the date of procurement of such goods or services. Conversely, instances where input tax credit legitimately availed needs to be reversed has also been dealt with under this Section.

18.2 Analysis

Eligibility of input tax credit on inputs held in stock and contained in semi-finished and finished goods held in stock: The credit on inputs held in stock and inputs contained in semi-finished goods and finished goods held in stock is available in the following manner:

Supplier	Inputs	Input Services	Capital Goods	Stock to be considered as on
Liabe for registration (crosses the turnover of Rs 20 Lakhs) – Applies for registration within 30 days of becoming liable for registration and obtains registration	Available	Not Available	Not Available	Day immediately preceding the date from which he becomes liable to pay tax
Voluntary Registration	Available	Not Available	Not Available	Day immediately preceding the date of grant of registration
Composition Scheme to Regular Scheme	Available	Not Available	Available	Day immediately preceding the date from which supplier is liable to pay tax under regular scheme
Exempt Supplies become Taxable	Available	Not Available	Available (Only for capital goods used exclusively for exempt supplies)	Day immediately preceding the date from which exempt supplies become taxable

Note – The challenges on eligibility uniformly is before the Courts under Article 14, which may enable one to avail the credit in case the decisions are favourable..

Credit on inputs includes inputs and inputs contained in semi-finished and finished goods. Credit on input services is not available under any circumstance.

- Declaration in Form GST ITC-01 must be filed within thirty days from the date of becoming eligible to input tax credit. Rule 40 of Central Goods and Service Tax Rules, 2017 requires a declaration to be filed containing details of stocks and capital goods along with a certificate from a practicing Chartered Accountant or Cost Accountant where the aggregate credit of CGST, SGST/UTGST and IGST so claimed exceeds ₹ 2 lakhs.
- The supplier would not be entitled to credit of goods or services or both after expiry of 1 year from date of issue of tax invoice (this restriction applies even to capital goods though this may not have been the intention).
- The credit on capital goods shall be reduced by five percentage per quarter or part thereof from the date of invoice.
- Credits are subject to verification of details furnished by the supplier in GSTR-1 or GSTR-4 on the common portal only in case of conversion from composition to regular scheme or when exempt supplies become taxable supplies. Verification is not possible for new registration cases as the supplier was unregistered at the time of procurement.

Examples:

- (i) A person becomes liable to pay tax on 1st August 2017 and has obtained registration on 15th August 2017. Such person is eligible for input tax credit on inputs held in stock as on 31st July 2017.
- (ii) Mr. Ann applies for voluntary registration on 5th June 2017 and obtained registration on 22th June 2017. Mr. A is eligible for input tax credit on inputs in stock as on 21st June 2017.
- (iii) Mr. B, registered person was paying tax under composition rate upto 30th July 2017. However, w.e.f 31st July 2017. Mr. B becomes liable to pay tax under regular scheme. Mr. B is eligible for input tax credit on inputs held in stock as on closure of business hours on 30th July 2017.

Illustration (Rule 40): Manner of claiming credit in special circumstances

Akshay Steels Limited is a manufacturer of iron & steel. It procures raw materials and inputs such as iron ore, chemicals, gases, etc. and capital goods including plant & machinery, for the manufacture of such iron & steel. In this example, it has been assumed that iron & steel (which is the outward supply of Akshay Steels Ltd) is exempt from payment of taxes until 31-Mar-2020. Iron & steel become taxable with effect from 01-Apr-2020. The method of availment of input tax credits on inputs contained in stock and capital goods as on 31-Mar-2020 is covered by this illustration

Particulars	Amount (₹)
Value of inputs in stock on 31-Mar-2020	1,00,000
IGST @18%	18,000
All inputs were procured after 01-Jul-2019	
Value of inputs contained in semi-finished goods held in stock on 31-Mar-2020	4,00,000
CGST @ 6%	24,000
SGST @ 6%	24,000
All inputs contained in semi-finished goods were procured after 01-May-2019	
Value of inputs contained in finished goods held in stock on 31-Mar-2020	50,000
CGST @ 6%	3,000
SGST @ 6%	3,000
Only inputs worth ₹ 40,000 in finished goods were procured after 01-Apr-2019	
Capital Goods procured vide invoice dated 22.01.2020	20,00,000
IGST Paid @ 18%	3,60,000
Credit available in respect of inputs:	
CGST (Note 1)	26,400
SGST (Note 2)	26,400
IGST (Note 3)	18,000
Total credit available on inputs	70,800
Value of capital goods used exclusively in relation to exempted goods held on 31-Mar-2020	20,00,000
IGST @ 18%	3,60,000
Credit available in respect of capital goods:	
Date of invoice of capital goods	22-Jan-2020
Date from which the exempt goods become taxable	01-Apr-2020
No. of quarters from date of invoice	1

Percentage points to be reduced (5% per quarter) (Note 4)	5%
IGST paid on the capital goods used exclusively in relation to goods exempted up to 31-Mar-2020	3,60,000
ITC to be reduced by 5%	(18,000)
Credit (IGST) available on capital goods	3,42,000

Working notes:

Note 1: CGST credits on inputs in stock held on 31-Mar-2020:

a	ITC on the value of inputs		
b	ITC on the value of inputs contained in semi-finished goods: All inputs were acquired within 1 year prior to the effective date on which the goods become taxable. Hence, entire ITC would be allowed.	24,000	
c	ITC on the value of inputs contained in finished goods: Out of the total stock of ₹ 50,000/-, inputs totalling to ₹ 10,000/- are older than 1 year from the effective date on which the goods become taxable. Therefore, ITC to this extent stands disallowed. ITC on inputs contained in stock of ₹ 40,000 would be eligible. [Eligible credit = 40,000 * 6%]	2,400	
	CGST credit available on inputs		26,400

Note 2: SGST credits on inputs in stock held on 31-Mar-2020:

a	ITC on the value of inputs		
b	ITC on the value of inputs contained in semi-finished goods: <i>Refer Note 1</i>	24,000	
c	ITC on the value of inputs contained in finished goods: <i>Refer Note 1</i>	2,400	
	SGST credit available on inputs		26,400

Note 3: IGST credits on inputs on stock held on 31-Mar-2020:

a	ITC on the value of inputs: All inputs were acquired within 1 year prior to the effective date on which the goods become taxable. Hence, entire ITC would be allowed.	18,000	
b	Input tax credit on the value of inputs contained in semi-finished goods	-	
c	Input tax credit on the value of inputs contained in finished goods	-	
	IGST credit available on inputs		18,000

Note 4: Rule 40(1)(a) of the Central Goods and Service Tax Rules, 2017 provides that input tax credit on capital goods can be claimed after reducing 5% per quarter of a year or part thereof, from the date of invoice in respect of which capital goods are received. Therefore, the number of quarters is 1, being the first quarter of the year 2020. The reversal of credit would therefore be, to the extent of ₹ 18000 (5% of ₹ 3,60,000).

Illustration (Rule 42): Manner of determination of ITC in respect of inputs or input services and reversal thereof

Rule 42 of the Central Goods and Services Tax Rules, 2017

Sl. No	Particulars	Reference	CGST	SGST/UTGST	IGST
1	Total input tax on inputs and input services for the tax period May 2018	T	1,00,000	1,00,000	50,000
	Out of the total input tax (T):				
2	Input tax used exclusively for non-business purposes (Note 1)	T1	10,000	10,000	5,000
3	Input tax used exclusively for effecting exempt supplies (Note 1)	T2	10,000	10,000	5,000
4	Input tax ineligible under Section 17(5) (Note 1)	T3	5,000	5,000	2,500
	Total		25,000	25,000	12,500
	ITC credited to Electronic Credit Ledger (Note 1)	$C1 = T - (T1 + T2 + T3)$	75,000	75,000	37,500
	Input tax credit used exclusively for taxable supplies (including zero-rated supplies)	T4	50,000	50,000	25,000
	Common credit	$C2 = C1 - T4$	25,000	25,000	12,500
	Aggregate value of exempt supplies for the tax period May 2018 (Note 2 & 3)	E	25,00,000	25,00,000	25,00,000

	Total Turnover of the registered person for the tax period May 2018 (Note 2)	F	1,00,00,000	1,00,00,000	1,00,00,000
	Credit attributable to exempt supplies	$D1 = (E/F) * C2$	6,250	6,250	3,125
	Credit attributable to non-business purposes	$D2 = C2 * 5\%$	1,250	1,250	625
	Net eligible common credit	$C3 = C2 - (D1 + D2)$	17,500	17,500	8,750
	Total credit eligible (Exclusive + Common)	G = T4 + C3	67,500	67,500	33,750

Note 1: T1, T2, T3 and T4 shall be determined as above and declared in Form GSTR-2 at the invoice level.

Note 2: If the registered person does not have any turnover for May 2018, then the value of Exempt Supplies (E) and Total Turnover (F) shall be considered for the last tax period for which such details are available

Note 3: Aggregate value excludes taxes

Note 4: The registered person is expected to make such computation for each tax period and reverse the same in the periodic returns being filed by such registered person. However, on completion of the financial year, input tax credit shall be determined accurately based on actuals, in the same manner as provided in Rule 42. A true up is required to be done on an annual basis (between the amounts reversed for each tax period during the year and the amount determined at the end of the financial year) and any excess credit availed needs to be reversed with interest while short credit, if any, needs to be re-availed within 6 months from end of the financial year.

It is to be noted that the registered person would be required to remit excess ITC claimed (as determined in Note 4 above) with interest calculated at for the period starting from the first day of April of the succeeding financial year till the date of payment. However, no interest can be claimed if, at the end of the financial year, it is found that short credit was availed.

Illustration (Rule 43): Manner of determination of ITC in respect of capital goods and reversal thereof in certain cases

Sl. No	Particulars	Reference	IGST
1	ITC on capital goods used exclusively for non-business purposes (Note 1)	T1	10,000

2	ITC on capital goods used exclusively for effecting exempt supplies (Note 1)	T2	10,000
	Total		20,000
3	ITC on capital goods used exclusively for taxable supplies (including zero-rated supplies) (Note 1)	T3	50,000
4	ITC on capital goods (other than T1, T2 and T3) (Annexure A)	A= b+f	3,90,000
5	ITC on capital goods whose residual life remain in beginning of tax period (Annexure A)	Tr	6,500
7	Aggregate value of exempt supplies for the tax period May 2018 (Note 2 & 3)	E	25,00,000
8	Total Turnover of the registered person for the tax period May 2018 (Note 2)	F	1,00,00,000
10	Credit attributable to exempt supplies	$T_e = \frac{(E/F) *}{Tr}$	1,625

Note 1: T1, T2 and T3 should be declared in Form GSTR-2. T3 (being ITC on capital goods used for taxable supplies) and A (being common credit in respect of capital goods) shall only be credited to the electronic credit ledger

Note 2: If the registered person does not have any turnover for May 2018, then the value of E and F shall be considered for the last tax period for which such details are available

Note 3: Aggregate value excludes taxes

Annexure A - ITC on capital goods whose residual life is remaining

Sl. No	Particulars	Reference	Amount
For May 2018			
1	Inward supply value of Machinery X	A	12,50,000
	IGST @ 12%	B	1,50,000
	Invoice Value		14,00,000
	Date of inward supply		12 April 2018
	Life of the capital goods (in months) - for GST purpose is 5 years	C	60
	ITC attributable for 1 month	$T_{m1} = b/c$	2500
2	Inward supply value of Machinery Y	E	20,00,000
	IGST @ 12%	F	2,40,000

	Invoice Value		22,40,000
	Date of inward supply		21 May 2018
	Life of the capital goods (in months) - for GST purpose is 5 years	G	60
	ITC attributable for May 2018 (1 month)	$Tm2 = f/g$	4000
	Aggregate of ITC on common credits	$Tr = Tm1 + Tm2$	6500

Rule 44 mandates credit reversal when a registered person switches from regular scheme to composition scheme or goods and services supplied by him become wholly exempt:

- Pay an amount by debiting electronic cash ledger / credit ledger, equivalent to input tax credit of -
 - Inputs held in stock
 - Inputs contained in semi-finished or finished goods held in stock and
 - Capital goods
- On the day immediately preceding the date of such switch over.
- Balance of input tax credit lying in the electronic credit ledger, after payment of the above said amount, shall lapse.
- Such amount is calculated in manner to be prescribed

Pay and Exit Scheme:

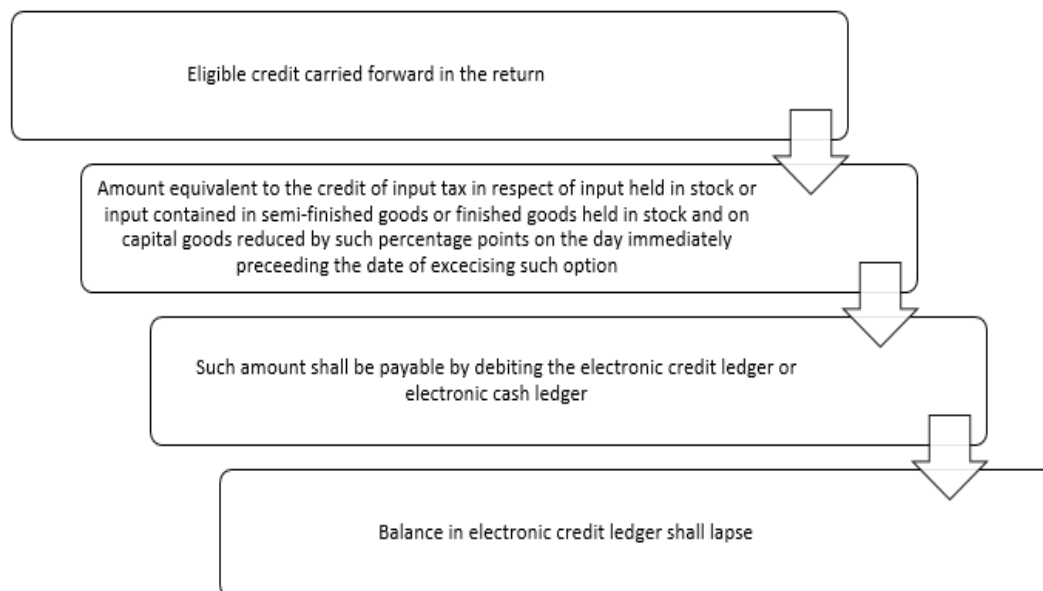

Illustration 1: Where input tax credit lapses

Sl. No	Particulars	Reference	Amount
1	Value of capital goods		1,00,000
	IGST @ 12%	A	12,000
	Invoice Value		1,12,000
2	Date of shift to composition scheme		01 April 2019 (Can be opted in Financial year beginning)
3	Date of inward supply and use of capital goods		01 September 2017
4	Period of use (days)		577
	Period of use (months)		19
5	Residual life in months	B	41
	(Considering full life as 5 years)		
6	ITC attributable to residual life (To be added to the output tax liability of the registered person)	$C = (A*B/60)$	8,200
5	Balance of ITC as on 31.03.2019		10,000
6	ITC utilized for capital goods for residual life		8,200
7	Balance ITC - would lapse		1,800

Illustration 2: Where input tax credit becomes payable

Sl. No	Particulars	Reference	Amount
1	Value of capital goods		1,00,000
	IGST @ 12%	A	12,000
	Invoice Value		1,12,000
2	Date of shift to composition scheme		1st April 2019
3	Date of inward supply and use of capital goods		01 September 2017
4	Period of use (days)		577
	Period of use (months)		19
5	Residual life in months	B	41
	(Considering full life as 5 years)		

6	ITC attributable to residual life	C = (A*B/60)	8,200
	(To be added to the output tax liability of the registered person)		
5	Balance of ITC as on 31.03.2019		1,500
6	ITC utilized for capital goods for residual life		8,200
7	Balance tax payable		6,700

Illustration 3: Where no payment is required

Sl. No	Particulars	Reference	Amount
1	Value of capital goods		1,00,000
	IGST @ 12%	A	12,000
	Invoice Value		1,12,000
2	Date of shift to composition scheme		1st April, 2023
3	Date of inward supply and use of capital goods		01 September 2017
4	Period of use (months)		67
	Period of use (years)		5 years 7 months
5	Residual life in months	B	-
	(Considering full life as 5 years)		
6	ITC attributable to residual life	C = (A*B/60)	0
	(No payment required)		

Input tax credit and change in constitution of registered person: The change in constitution of registered person due to sale, merger, demerger, amalgamation, lease or transfer or change in the ownership of business including transfer of liabilities provides for the following:

- (i) The registered person is allowed to transfer the input tax credit remaining unutilized in the electronic credit ledger .to such sold, merged, demerged, amalgamated, leased or transferred business.
- (ii) Rule 41 prescribes such credit transfer be made on the Common Portal in FORM GST ITC-02 and in case of demerger, credit to be transferred must be apportioned to the value of assets transferred in the arrangement to each such unit.

- (iii) A practicing Chartered Accountant or Cost Accountant to certify that the arrangement contains a specific provision for the transfer of liabilities.
- (iv) Details furnished in Form GST ITC-02 by the transferor would have to be accepted by the transferee on the Common Portal. Please refer to discussion on Registrations in case of such arrangements to examine the timing of seeking registration by transferee.
- (v) Transferee to duly account for the stocks & capital goods received in books of accounts.

The analysis of above provision in a pictorial form is summarised as follows:

ITC: Change in Constitution of registered Person

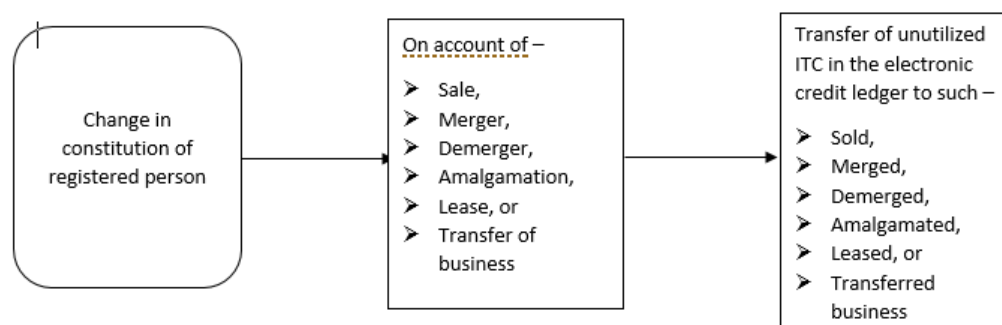

Supply of capital goods on which input tax credit is taken: The registered person shall pay an amount equal to the higher of:

- Input tax credit taken on such capital goods as reduced by such prescribed percentage points or
- the tax on the transaction value of such capital goods,

One striking difference becomes evident in Rule 40 in the manner of computation of ITC in respect of used capital goods under sub rule (1a) and sub rule (2). While sub rule (1a) deals with availment of input tax credit on capital goods after reducing “five percentage points **per quarter of a year** or part thereof”, sub rule (2) specifies computation of input tax credit by reducing “ five percentage points **for every quarter or part thereof** from the date of the issue of the invoice”.

From the above we may come to the following conclusion:

- For the purpose of sub-rule (1a), quarter shall mean a ‘calendar quarter’
- For the purpose of sub-rule (2), the quarter shall be computed from the date on the invoice.
- For example: a capital good purchased on 25th March, 2018 would be reduced by 5 percentage points for the quarter ending March 2018 for the purpose of sub-rule (1a) while the same assets would be reduced by 5 percentage points for the period ranging between 25.03.2018 to 24.06.2018 and so on.

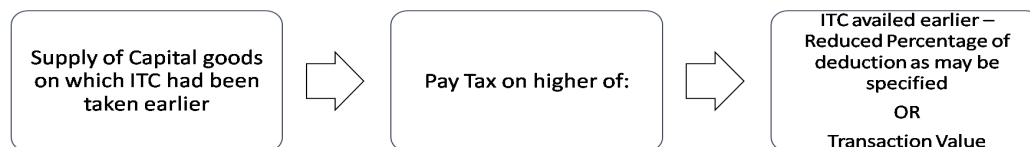
Supply of Capital goods on which ITC already taken

Please note that there is no saving clause in the event the taxable person entertained a *bona fide* view as to the non-taxability of certain supplies or availability of an exemption which is later overturned by a superior Court and the demand crystallizes. In this scenario, limitation of availment of input tax credit lands a double blow to this taxable person. That is, not only would GST have been paid on inputs, input services and capital goods on which no credit would have been availed (due to this *bona fide* view having been entertained) but also, the full extent of the output tax becomes payable (without any relief towards credit that would otherwise have been available) due to the decision of the superior Court. One needs to exercise caution while entertaining a view about non-taxability or exemption. At the same time, it is not permitted to take a hyper-conservative view – where even with the availability of a clear and absolute exemption, the taxable person chooses to pay GST in order to protect credit from the limitation. This option cannot be taken in view of the mandatory nature of such exemptions as clearly stated in explanation to section 11. It could lead to denial of credits as the supply was not taxable!

The difference between 'taxable person' and 'registered person' is important – they are two deliberately dissimilar phrases used in the law – and credit is allowed u/s 16(1) only to a 'registered person' whereas u/s 9(1) tax levied is payable by every 'taxable person' implying that the liability subsists even if not registered but credit is available only if registered.

Refractory bricks, moulds and dies, jigs and fixtures are supplied as scrap: Taxable person may pay tax on transaction value under section 15.

18.3 Issues and Concerns

It is important to note that unlike Rule 42 which mandates determination of the actual amount of reversal on the completion of the financial year, Rule 43 does not prescribe any re-computation at the end of the financial year. This could be presumed to be due to the fact that reversal of input tax credits under Rule 43 is based on number of tax periods unlike that of Rule 42. But considering the fact that reversal of common credits under Rule 43 is also based on the proportion of turnover of exempt supplies to the total turnover in the State for that tax period, due consideration should be given to the fact that any shortage of availment of ITC on account of any reason cannot be subsequently availed under Rule 43. On the other hand, any excess credit availed would promptly be subject to scrutiny by the proper officer.

18.4 Comparative review

Aspect	Credit under old regime	Input tax credit under GST regime
Credit on stock-in-hand	Rule 3(2) of CCR Rules, 2004	Specified persons in specified situations are eligible for input tax credit on stock
Credit on sale merger or transfer of business	Rule 10 of CCR Rules, 2004	Specific section covering the sale, merger etc
Reversal on goods becoming exempt	Rule 11(3) of CCR, 2004	To be reversed as per section 18(4)

Statutory Provisions**19. Taking input tax credit in respect of inputs and capital goods sent for job work**

- (1) *The “principal” shall, subject to such conditions and restrictions as may be prescribed, be allowed input tax credit on inputs sent to a job worker for job work.*
- (2) *Notwithstanding anything contained in clause (b) of sub-section (2) of section 16, the “principal” shall be entitled to take credit of input tax on inputs even if the inputs are directly sent to a job worker for job-work without being first brought to his place of business.*
- (3) *Where the inputs sent for job-work are not received back by the “principal” after completion of job-work or otherwise or are not supplied from the place of business of the job worker in accordance with clause (a) or clause (b) of sub-section (1) of section 143 within one year of being sent out, it shall be deemed that such inputs had been supplied by the principal to the job worker on the day when the said inputs were sent out:*
- Provided that where the inputs are sent directly to a job worker, the period of one year shall be counted from the date of receipt of inputs by the job worker.*
- (4) *The “principal” shall, subject to such conditions and restrictions as may be prescribed, be allowed input tax credit on capital goods sent to a job-worker for job-work.*
- (5) *Notwithstanding anything contained in clause (b) of sub-section (2) of section 16, the “principal” shall be entitled to take credit of input tax on capital goods even if the capital goods are directly sent to a job worker for job-work without being first brought to his place of business.*
- (6) *Where the capital goods sent for job-work are not received back by the “principal” within a period of three years of being sent out, it shall be deemed that such capital goods had been supplied by the principal to the job worker on the day when the said capital goods were sent out:*

Provided that where the capital goods are sent directly to a job worker, the period of three years shall be counted from the date of receipt of capital goods by the job worker.

- (7) *Nothing contained in sub-section (3) or sub-section (6) shall apply to moulds and dies, jigs and fixtures, or tools sent out to a job-worker for job-work.*

Explanation. —For the purpose of this section, “principal” means the person referred to in section 143

Extract of the CGST Rules, 2017

45. Conditions and restrictions in respect of inputs and capital goods sent to the job worker.

- (1) *The inputs, semi-finished goods or capital goods shall be sent to the job worker under the cover of a challan issued by the principal, including where such goods are sent directly to a job-worker.*
- (2) *The challan issued by the principal to the job worker shall contain the details specified in rule 55.*
- (3) *The details of challans in respect of goods dispatched to a job worker or received from a job worker or sent from one job worker to another during a quarter shall be included in FORM GST ITC-04* furnished for that period on or before the twenty-fifth day of the month succeeding the said quarter [or within such further period as may be extended by the Commissioner by a notification in this behalf:*

Provided that any extension of the time limit notified by the Commissioner of State tax or the Commissioner of Union territory tax shall be deemed to be notified by the Commissioner.]

- (4) *Where the inputs or capital goods are not returned to the principal within the time stipulated in section 143, it shall be deemed that such inputs or capital goods had been supplied by the principal to the job worker on the day when the said inputs or capital were sent out and the said supply shall be declared in FORM GSTR-1* and the principal shall be liable to pay the tax along with applicable interest.*

Explanation.- *For the purposes of this Chapter,-*

- (1) *the expressions “capital goods” shall include “plant and machinery” as defined in the Explanation to section 17;*
- (2) *for determining the value of an exempt supply as referred to in sub-section (3) of section 17-*
- (a) *the value of land and building shall be taken as the same as adopted for the purpose of paying stamp duty; and*
- (b) *the value of security shall be taken as one per cent. of the sale value of such security.*

Relevant circulars, notifications, clarifications issued by Government:

1. Chapter Nineteen of the compilation of the GST Flyers as issued by the CBIC on 'Input Tax Credit Mechanism in GST'
2. Chapter Twenty Seven of the compilation of the GST Flyers as issued by the CBIC on 'Job Work under GST'
3. Circular No. 38/2018 dated 26.03.2018 issued by CBIC being clarifications on issues related to Job Work

Related Provisions of the Statute:

Section or Rule	Description
Section 16	Eligibility and conditions for taking input tax credit
Section 143	Job work procedure
Rule 55	Transportation of goods without issue of invoice

19.1 Introduction

This provision relates to availment of credit of input tax on goods sent for job work.

19.2 Analysis**(i) Relevant Definitions:**

- **Job work:** Any treatment or process undertaken by a person on goods belonging to another registered person (section 2(68)).
- **Job worker:** A person who undertakes any treatment or process on goods belonging to another registered person.
- **Principal:** A person on whose behalf an agent carries on the business of supply or receipt of goods or services or both.

(ii) Entitlement of credit on inputs: The principal can take credit of input tax on inputs sent to job-worker subject to fulfilment of the following conditions:

- Rule 45 of Central Goods and Service Tax Rules, 2017 provides the following:
 - To issue a delivery challan for transfer of inputs to the job-worker including where they are sent directly (to maintain paper trail of transaction)
 - The details of delivery challans for goods dispatched to job worker or received from job worker or sent from one job worker to another during the quarter are to be included in Form GST ITC-04 to be furnished on or before 25th day of the month succeeding that quarter. Date of filing ITC-04 has however been extended from time to time.
 - Delivery challan is to contain all details as required in respect of an invoice prescribed in Rule 55 of Central Goods and Service Tax Rules, 2017. All delivery

challans issued in respect of inputs sent to a job-worker and those received back are to be reported in GSTR-1

- The inputs, after completion of job-work, are to be received back by the principal within 1 year of their being sent out.
- In case of non-receipt of the inputs within the time prescribed, the principal shall issue an invoice for the same and declare such supplies in his return for that particular month in which the time period of one year has expired.
- In case of direct supply, the period of 1 year shall be reckoned from the date the job worker receives such inputs.
- The credit of inputs can be taken even if inputs are sent directly to job-worker's premises without bringing it to principal's place of business.
- If the inputs are not received back within 1 year, it shall be deemed that such inputs had been supplied by principal to the job worker on the day when the said inputs were sent out.

(iii) Entitlement to credit on capital goods: The principal can take credit of input tax on capital goods sent to job-worker subject to the fulfilment of the following conditions:

- The capital goods, after completion of job-work, are received back by him within 3 years of their being sent out.
- The principal can take credit of capital goods even if such capital goods are sent directly to job-worker's place without bringing to principal's place of business.
- If the capital goods are not received back within 3 years, it shall be deemed that such capital goods had been supplied by principal to the job worker on the day when the said capital goods were sent out.
- Procedures listed in respect of inputs under Rule 45 of the Central Goods and Service Tax Rules, 2017 will equally apply to capital goods also (refer above).

Given that non-receipt of inputs or capital goods within a period of one year and three years respectively would be deemed to be a supply as on the date on which goods were originally dispatched to the job worker, it is preferred that a principal raises a tax invoice and supplies the goods against such invoice at the time of original supply, if he is certain that such goods would not be received within the period specified above. This would enable the principal from having to bear the burden of interest, as interest would be calculated from the date on which the goods were originally dispatched and not from the date on which the period of one year or three years, as the case may be, expires.

Some experts are of the view that unless the Principal is 'registered', the activity would not be 'job-work'. And when the supply – treatment or process – is not job-work, then it would also not be eligible to be classified under HSN 9988 in the Annexure – Scheme of Classification of Services. Although the nature of work performed is the same whether the Principal is registered or not, the classification of supplies would need to be based on another suitable

HSN code in chapter 99 because paragraph 3, Schedule II does refer to 'another person's goods' and not 'another registered person's goods'. Hence, due to the registration status of the Principal, the treatment or process may or may not qualify as job-work but in either case, the work of the supplier would continue to be 'treated as supply of services' though not under HSN 9988. It must be noted that while every manufacture may encompass 'process or job-work' every job-work need not necessarily result in manufacture. It is for this reason that in the rate notification manufacturing services has been separately mentioned for work carried out on "physical inputs owned by others".

Treatment of process undertaken may or may not result in manufacture (section 2(72)) where processing of raw material or inputs that results in the emergence of a new product. Whether it results in manufacture or not, the treatment or process would always be 'treated as supply of services' in view of the mandate specified in paragraph 3, schedule II.

Now, 'goods belonging to another' does not mean 100% of the goods required in the job-work must be provided by the Principal. It is common, and often inevitable, for the job-worker to apply his own goods. Goods required for job-work can generally be identified as primary, secondary and ancillary material. If the job-worker applies ancillary material in the course of carrying out the treatment or process, the transaction does not cease to be job-work. Similarly, if the Principal provides only ancillary material, it is not justifiable to regard the transaction as job-work. Hence, a reasonable construction of the definition of paragraph 3, schedule II requires the Principal to provide the 'primary material' at least to qualify a transaction to be termed as 'job work'. Although there are no infallible tests or undisputed guiding principle or no one-rule can be prescribed -the classification into primary-secondary-ancillary itself is a subjective matter. Reasonable construction is required based on the role, each component plays in relation to the finished product in terms of function and identity to determine 'goods belonging to another' correctly.

Please note that job-working must not be confused with repair or maintenance. Job-working creates the functionality of an article but repair or maintenance restores or improves the functionality already created and possessed by that article or thing.

As regards 'movement of goods' by Principal to job-worker, it is not a supply for the reason that the ingredients required to constitute supply (as detailed in the explanation of clause (a) to (c) under section 7(1)) are not satisfied. It is for this reason that section 19(3) and 19(6) is required to 'deem' this movement of goods to be a supply in the event of failure of job-worker to return processed goods within the permitted time (1 year for inputs and 3 years for capital goods, respectively). Further, 19(3) and 19(6) 'deem' it to be a supply not on the date of expiry of the permitted time to return them, but retrospectively on the date when the inputs / capital goods were originally sent 'for' job-work.

Deeming fiction is capable of providing a meaning that is otherwise not available to a work or phrase. Deeming fiction is used with great caution by the law-maker and when it is used, its construction must be with the same caution and seriousness. Hence, 'movement of goods' for

the purpose of job-work is not supply but is 'deemed' to be a supply by failure of a contingency or condition-subsequent.

It is section 16 and not section 19 that allows input tax credit, but section 19 permits availment of input tax credit even when the inputs (or capital goods) are not first received at the premises of the Principal but delivered directly to job-worker. Section 19 also does not deny or recover the input tax credit already availed by the Principal on the occasion of sending them to the job-worker. When movement of goods for job-work is not a supply, where is the need for a provision to permit continuation of credit that was already availed validly. Since credit has been availed, failure to use the inputs (or capital goods) as 'intended' under section 16(1) would cause a break-down of the credit scheme – to allow credit only when the said goods are subsequently supplied and are taxable. And for this reason, transfer of business assets on which credit availed is 'declared' to be supply in paragraph 1, schedule I and diversion for non-business use (in certain cases) is 'treated' as supply in paragraph 4(a) and 4(b), schedule II. But there is no provision to impute supply characteristics to 'movement of goods for job-work'. This responsibility is cast by section 19(3) and 19(6), respectively.

This can be contrasted with the 'time of supply' of goods sent-on-approval under section 31(7). Here, the date of acceptance by customer (or end of 6th month) is recognized as supply and hence registers 'time of supply'. It is interesting to note that there is deeming fiction employed here because none is required. In other words, 'sending goods on approval' is not a supply for the same reason that the ingredients required to constitute supply (as detailed in the explanation of clause (a) to (c) under section 7(1)) are not satisfied. And such a test can validly be applied for verifying whether 'movement of goods for job-work' is supply or not. By applying the same test to 'sending goods on approval', the 'time of supply' is not the date of sending them but the date of their acceptance by customer (or end of 6th month).

19.3 Comparative review

Aspect	Credit under erstwhile system	Input tax credit under CGST
Definition of "job work"	Defined in Cenvat Credit Rules to mean processing of material supplied to job worker to complete whole or part of manufacturing process	Defined to mean undertaking any treatment or process by a person on goods belonging to another registered person
Eligibility of Cenvat credit to principal manufacturer	Principal is eligible for Cenvat credit	Similar in CGST. Principal is eligible for Cenvat credit
Conditions for return of inputs and capital goods	For inputs – 180 days For capital goods – 2 years	For inputs – 1 year For capital goods – 3 years
Reversal of credit if inputs/capital goods not	Credit to be reversed	To be treated as deemed supply on the day when

returned within specified time		such inputs/capital goods are sent out
Re-credit if goods returned after specified time	Re-credit allowed	No such provision

19.4 FAQs

Q1. Whether the principal is eligible to avail input tax credit of inputs sent to job worker for job work?

Ans. Yes. The principal is eligible to avail the input tax credit on inputs sent to job worker for job work.

19.5 MCQs

Q1. The inputs sent to job work has to be received back within:

- (a) 1 year
- (b) 2 years
- (c) 180 days

Ans. (a) 1 year.

Q2. The principal is entitled to avail the credit on capital goods sent to job worker directly:

- (a) Yes
- (b) No
- (c) May be

Ans. (a) Yes.

Q3. If the capital goods sent to job worker has not been received within 3 years from the date of being sent:

- (a) Principal has to pay amount equal to credit taken on such capital goods
- (b) No need to pay amount equal to credit taken on such capital goods
- (c) It shall be treated as deemed supply of capital goods to the job worker
- (d) None of the above

Ans. (c) It shall be treated as deemed supply of capital goods to the job worker

Statutory provisions**20. Manner of distribution of credit by Input Service Distributor**

(1) *The Input Service Distributor shall distribute the credit of central tax as central tax or integrated tax and integrated tax as integrated tax or central, by way of issue of a document*

containing, the amount of input tax credit being distributed in such manner as may be prescribed.

(2) The Input Service Distributor may distribute the credit subject to the following conditions, namely:

- (a) the credit can be distributed to recipients of credit against a document containing such details as may be prescribed;
- (b) the amount of the credit distributed shall not exceed the amount of credit available for distribution;
- (c) the credit of tax paid on input services attributable to recipient of credit shall be distributed only to that recipient;
- (d) the credit of tax paid on input services attributable to more than one recipient of credit shall be distributed amongst such recipient(s) to whom the input service is attributable and such distribution shall be pro rata on the basis of the turnover in a State or turnover in a Union Territory of such recipient, during the relevant period, to the aggregate of the turnover of all such recipients to whom such input service is attributable and which are operational in the current year, during the said relevant period;.
- (e) the credit of tax paid on input services attributable to all recipients of credit shall be distributed amongst such recipients and such distribution shall be pro rata on the basis of the turnover in a State or turnover in a Union Territory of such recipient, during the relevant period, to the aggregate of the turnover of all recipients and which are operational in the current year, during the said relevant period.

Explanation –For the purposes of this section,

- (a) the “relevant period” shall be-
 - (i) if the recipients of credit have turnover in their States or Union Territories in the financial year preceding the year during which credit is to be distributed, the said financial year; or
 - (ii) if some or all recipients of the credit do not have any turnover in their States or Union Territories in the financial year preceding the year during which the credit is to be distributed, the last quarter for which details of such turnover of all the recipients are available, previous to the month during which credit is to be distributed.
- (b) the expression of ‘recipient of credit’ means the supplier of goods or services or both having the same Permanent Account Number as that of Input Service Distributor.
- (c) the term ‘turnover’ in relation to any registered person engaged in the supply of taxable goods as well as goods not taxable under this Act, means the value of

*turnover, reduced by the amount of any duty or tax levied **under entries 84 and entry 92A**³ of List I of the Seventh Schedule to the Constitution and entry 51 and 54 of List II of the said Schedule*

Extract of the CGST Rules, 2017

39. Procedure for distribution of input tax credit by Input Service Distributor

(1) An Input Service Distributor shall distribute input tax credit in the manner and subject to the following conditions, namely, -

- (a) the input tax credit available for distribution in a month shall be distributed in the same month and the details thereof shall be furnished in FORM GSTR 6* in accordance with the provisions of Chapter VIII of these rules;
- (b) the Input Service Distributor shall, in accordance with the provisions of clause (d), separately distribute the amount of ineligible input tax credit (ineligible under the provisions of sub-section (5) of section 17 or otherwise) and the amount of eligible input tax credit;
- (c) the input tax credit because central tax, State tax, Union territory tax and integrated tax shall be distributed separately in accordance with the provisions of clause (d);
- (d) the input tax credit that is required to be distributed in accordance with the provisions of clause (d) and (e) of sub-section (2) of section 20 to one of the recipients 'R1', whether registered or not, from amongst the total of all the recipients to whom input tax credit is attributable, including the recipient(s) who are engaged in making exempt supply, or are otherwise not registered for any reason, shall be the amount, "C₁", to be calculated by applying the following formula –

$$C_1 = (t_1 \div T) \times C$$

where,

"C" is the amount of credit to be distributed,

"t₁" is the turnover, as referred to in section 20, of person R₁ during the relevant period, and

"T" is the aggregate of the turnover, during the relevant period, of all recipients to whom the input service is attributable in accordance with the provisions of section 20;

- (e) the input tax credit on account of integrated tax shall be distributed as input tax credit of integrated tax to every recipient;
- (f) the input tax credit on account of central tax and State tax or Union territory tax shall
 - (i) in respect of a recipient located in the same State or Union territory in which the

³ Inserted vide The Central Goods and Services Tax Amendment Act, 2018 w.e.f. 01.02.2019

- Input Service Distributor is located, be distributed as input tax credit of central tax and State tax or Union territory tax respectively;
- (ii) in respect of a recipient located in a State or Union territory other than that of the Input Service Distributor, be distributed as integrated tax and the amount to be so distributed shall be equal to the aggregate of the amount of input tax credit of central tax and State tax or Union territory tax that qualifies for distribution to such recipient in accordance with clause (d);
 - (g) the Input Service Distributor shall issue an Input Service Distributor invoice, as prescribed in sub-rule (1) of rule 54, clearly indicating in such invoice that it is issued only for distribution of input tax credit;
 - (h) the Input Service Distributor shall issue an Input Service Distributor credit note, as prescribed in sub-rule (1) of rule 54, for reduction of credit in case the input tax credit already distributed gets reduced for any reason;
 - (i) any additional amount of input tax credit on account of issuance of a debit note to an Input Service Distributor by the supplier shall be distributed in the manner and subject to the conditions specified in clauses (a) to (f) and the amount attributable to any recipient shall be calculated in the manner provided in clause (d) and such credit shall be distributed in the month in which the debit note is included in the return in FORM GSTR-6*;
 - (j) any input tax credit required to be reduced on account of issuance of a credit note to the Input Service Distributor by the supplier shall be apportioned to each recipient in the same ratio in which the input tax credit contained in the original invoice was distributed in terms of clause (d), and the amount so apportioned shall be
 - (i) reduced from the amount to be distributed in the month in which the credit note is included in the return in FORM GSTR-6*; or
 - (ii) added to the output tax liability of the recipient where the amount so apportioned is in the negative by the amount of credit under distribution being less than the amount to be adjusted.
 - (2) If the amount of input tax credit distributed by an Input Service Distributor is reduced later for any other reason for any of the recipients, including that it was distributed to a wrong recipient by the Input Service Distributor, the process specified in clause (j) of sub-rule (1) shall apply, mutatis mutandis, for reduction of credit.
 - (3) Subject to sub-rule (2), the Input Service Distributor shall, on the basis of the Input Service Distributor credit note specified in clause (h) of sub-rule (1), issue an Input Service Distributor invoice to the recipient entitled to such credit and include the Input Service Distributor credit note and the Input Service Distributor invoice in the return in FORM GSTR-6* for the month in which such credit note and invoice was issued.

Relevant circulars, notifications, clarifications issued by Government:

1. Chapter Nineteen of the compilation of the GST Flyers as issued by the CBIC on 'Input Tax Credit Mechanism in GST'
2. Chapter Ten of the compilation of the GST Flyers as issued by the CBIC on 'Input Service Distributor in GST'

Related Provisions of the Statute

Section or Rule	Description
Section 2(61)	Definition of 'Input Service Distributor'
Section 16	Eligibility and conditions for taking input tax credit
Section 17	Apportionment of credit and blocked credits
Rule 54	Tax invoice in special cases
Rule 65	Form and manner of submission of return by an Input Service Distributor

20.1 Introduction

This Section sets forth the way input tax credit (of services) is distributed to supplier of goods or services or both of same entity having same PAN. Procedure for distribution is given in Rule 39 of Central Goods and Service Tax Rules, 2017.

20.2 Analysis

- (i) An ISD shall distribute the eligible ITC in accordance with Rule 39 elucidated in the following paras.
- (ii) Input Service Distributor (ISD) is an office of the supplier of goods or services or both where a document (like invoice) of services attributable to other locations are received (since they might be registered separately). Since the services relate to other locations the corresponding credit should be transferred to such locations (having separate registrations) as services are supplied from there. Care should be taken to ensure that an inter-branch supply of services should not be misinterpreted as a distribution by ISD. Please recollect that ISD cannot be an office that does any supply of its own but must be one that merely collects invoice for services and issues prescribed document for its distribution.
- (iii) ISD cannot normally be used in a situation where there is a liability to pay GST. It can only receive input tax credits on invoices related to input services and distribute such credits in the manner discussed below. An ISD cannot discharge tax liability under reverse charge. This would require obtaining another registration as a regular registered person and discharge RCM liability.

Examples hereunder are as per rules.

Illustration: Corporate office of XYZ company Ltd., is at New Delhi, having its business locations of selling and servicing of goods at New Delhi, Chennai, Mumbai and Kolkata. For example, if the software license and maintenance is used at all the locations, invoice indicating CGST and SGST is received at Corporate Office. Since the software is used at all the four locations, the input tax credit of entire services cannot be claimed at New Delhi. The same has to be distributed to all four locations. For that reason, the Delhi Corporate office has to act as ISD to distribute the credit.

Rule 39: Central Goods and Service Tax Rules, 2017

The example provided below illustrates the application of Rule 39 of the Central Goods and Service Tax Rules, 2017 for distribution of credits by an Input Service Distributor (ISD) in terms of Section 20.

Yoko Infotech Ltd. has its head office in Mumbai, for which it additionally has an ISD registration. The company has 12 units across India including its head office. It receives the following invoices in the name of the ISD at Mumbai, for the month of January 2018:

Invoice A: ₹ 100,000 @ **IGST** 18,000 issued by Peace Link Technologies (registered in Uttar Pradesh) for repairs executed in 3 units – **Bangalore, Kolkata, Gurgaon** (Note: Gurgaon location is not registered as it is engaged in making only exempt supplies);

Invoice B: ₹ 300,000 @ **CGST** 27,000, **SGST** 27,000 issued by M/s. Tec Force (registered in Pune) for repairs executed in 3 units – **Mumbai, Bangalore, Kolkata**;

Invoice C: ₹ 500,000 @ **IGST** 90,000 issued by M/s. Georgia Marketing (registered in Bangalore) for marketing services for the **company**;

Invoice D: ₹ 10,000 @ **CGST** 900 & **SGST** ₹900 issued by M/s. Gopal Coffee works (registered in Mumbai) for supply of beverages during the month to its **Mumbai unit**.

All taxes have been considered at 18% (CGST and SGST at 9% each).

The turnover of each of the units during the year 2016-17 is: Mumbai: 1 crore; Bangalore 2 crore; Kolkata 1 crore; Gurgaon 2 crore; each of the other 8 units: 50 lakhs, resulting in the aggregate turnover of the company in the previous financial year, of 10 crores.

Distribution of credits by the ISD:

Particulars	Invoice	Bangalore	Kolkata	Mumbai	Gurgaon	8 units	Total
Invoice A							
T/o in State	Note 1	2 crore	1 crore	-	2 crore	-	5 crore
Pro-rata ratio		40%	20%	-	40%	-	100%
Credit	18,000	7,200	3,600	-	7,200	-	18,000
Type	IGST	IGST	IGST	-	IGST	-	

Invoice B							
T/o in State	Note 2	2 crore	1 crore	1 crore	-	-	4 crore
Pro-rata ratio		50%	25%	25%	-	-	100%
CGST Credit	27,000						
• Distribution		13,500	6,750	6,750	-	-	27,000
Type	CGST	IGST	IGST	CGST	-	-	
SGST Credit	27,000						
• Distribution		13,500	6,750	6,750	-	-	27,000
Type	SGST	IGST	IGST	SGST	-	-	
Invoice C							
T/o in State	Note 3	2 crore	1 crore	1 crore	2 crore	0.5 * 8 crore	10 crore
Pro-rata ratio		20%	10%	10%	20%	5% * 8 units	100%
Credit	90,000	18,000	9,000	9,000	18,000	4,500 * 8 units	90,000
Type	IGST	IGST	IGST	IGST	IGST	IGST	
Invoice D							
Attributable to	Note 4	-	-	Yes	-	-	-
Credit (ineligible)	900	-	-	900	-	-	900
Type	CGST	-	-	CGST	-	-	
Credit (ineligible)	900	-	-	900	-	-	900
Type	SGST	-	-	SGST	-	-	
Credit of CGST, SGST and IGST on invoice		Total eligible credits distributed as CGST, SGST and IGST as applicable (Refer Note below)					
CGST	27,000	-	-	6,750	-	-	6,750

SGST	27,000	-	-	6,750	-	-	6,750
IGST	108,000	52,200	26,100	9,000	25,200	4,500 each (viz. total of 36,000)	148,500
TOTAL	162,000	52,200	26,100	22,500	25,200	36,000	162,000

It can be seen from the illustration that credit of CGST of ₹ 27,000 is distributed as CGST credit only to the extent of ₹ 6,750; likewise, credit of SGST of ₹ 27,000 is distributed as SGST credit only to the extent of ₹ 6,750. This is because, the intra-State service billed to the ISD is attributable to 1 unit in the same State as the ISD and 2 other units located in different State. Thus, the balance of CGST credit and SGST credit is distributed as IGST to such units. This is the reason why the credit of IGST lying with the ISD prior to distribution is only ₹ 108,000 while the credit of IGST that is distributed aggregates to ₹ 148,500.

Note 1: The credit of IGST should always be distributed as IGST credit to all the units to which the service is attributable, regardless of where they are located.

- The credits should be distributed only to those units to which the service is attributable. Given that the service mentioned in the case of Invoice A is attributable only to Bangalore, Kolkata and Gurgaon, the entire input tax credit applicable to the case should be distributed to the said 3 units, on a pro rata basis in the ratio of their respective 'Turnover in State' to the aggregate of the 3 'Turnover in State' (i.e., 2 Cr + 1Cr + 2 Cr). Further, no differentiation is made to whether the unit is registered or not, and therefore, credit attributable to the Gurgaon unit is distributed to that unit although it is not registered, which implies, it is a loss of credit.
- The 'turnover in State' is arrived at a value for the 'relevant period'. Since all 12 units were operational during the preceding financial year, the relevant period would be the preceding financial year.

Note 2: The credit of CGST and SGST should be distributed as IGST credit to all the units located outside the State in which the ISD is located, and as CGST and SGST respectively, in case of distribution of credit to a unit located in the same State as the ISD. Thus, the CGST and SGST credits are distributed as IGST credits to Bangalore and Kolkata, and as CGST & SGST respectively, to Mumbai.

- Given that the service supplied in terms of Invoice B is attributable only to Bangalore, Kolkata and Mumbai, the entire input tax credit applicable to the case should be distributed to the said 3 units, on a pro rata basis in the ratio of their respective 'Turnover in State' to the aggregate of the 3 'Turnover in State' (i.e., 2 Cr + 1Cr + 1 Cr).

Note 3: The credit of IGST is distributed as IGST to all the units to which the service is attributable.

- Invoice C relates to a supply of service that is attributable to all the units, and hence,

the credits would be distributed on a pro-rata basis of the 'Turnover in State' of each of the units, to the aggregate of 'Turnover in State' of all the 12 units, i.e., ₹10 Cr.;

- For convenience of presentation, only one column is shown to reflect the distribution to each of the 8 units, having the same 'turnover in State', and to which the same invoice is attributable.

Note 4: Given that the services for receipt of food and beverages would not be eligible input services, the taxes relating to Invoice D should be distributed as ineligible input tax (900 + 900), and the distribution must be done separately.

Since the service is wholly attributable to the Mumbai unit, the distribution is done only to such unit.

- (iv) **Distribution of credit where ISD and recipient are located in different States under CGST Act:** As per Rule 39(1)(e) and (f) of Central Goods and Service Tax Rules, 2017 ISD shall distribute as prescribed, credit of CGST as CGST or IGST and credit of IGST as IGST by issuing prescribed document mentioning the amount of credit distributed to recipient of credit located in different States.

Illustration: In the above illustration, if the corporate office of XYZ Ltd being an ISD situated in Delhi receives invoices indicating ₹ 4 lakhs of CGST in one service and ₹ 7 lakhs as of IGST in another case. It shall distribute CGST of ₹ 4 Lakhs IGST and credit of IGST of ₹ 7 Lakhs also as IGST to its locations at Chennai, Mumbai and Kolkata under a prescribed document containing the amount of credit distributed.

- (v) **Distribution of credit where ISD and recipient are located in different States under SGST Act:** ISD could distribute as prescribed credit of SGST as IGST only (and not as SGST of other State) by issuing a prescribed document containing the amount of credit distributed.

Illustration: In the above illustration, corporate office of XYZ Ltd., also received SGST of ₹ 6 Lakhs along with ₹ 4 Lakhs of CGST. It can distribute SGST credit as IGST to its locations at Chennai, Mumbai and Kolkata under a prescribed document containing the amount of credit distributed.

- (vi) **Distribution of credit where ISD and recipient are located within the State under CGST Act:** In cases where an entity has different registration within the same State by an entity, it may have to distribute credit to such location also similar to locations with different registrations outside the State. In order to enable the same, it is provided that ISD can distribute in the prescribed manner, credit of CGST as CGST and credit of IGST as IGST by issuing prescribed document mentioning the amount of credit distributed to recipient being a business vertical.

Illustration: ABC Ltd., having its office at Bangalore is having another business vertical in Mysore which is separately registered. In such a case, out of input tax credit of ₹ 4 lakhs of CGST, the credit attributable to ABC Ltd, Bangalore, shall be distributed to

Mysore location as CGST. Similarly out of input tax credit of ₹ 10 Lakh of IGST, the credit attributable to ABC Ltd, Bangalore shall be distributed to Mysore location as IGST.

- (vii) **Distribution of credit where ISD and recipient are located within the State under SGST Act:** Similar to the provisions of CGST as indicated supra under CGST Act, even under the SGST Act, it is provided that an ISD can distribute in the prescribed manner, credit of SGST and IGST as SGST (of the same State and not other State) and IGST respectively, by issuing a prescribed document mentioning the amount of credit distributed to recipient being a business vertical.

Illustration: In the same example of ABC Ltd., above the input tax credit say ₹ 6 lakhs of SGST shall be distributed as SGST.

- (viii) **Conditions to distribute credit by ISD:** The conditions to distribute the credit by ISD are as follows:
- Credit to be distributed to recipient under prescribed documents containing prescribed details. Such document should be issued to each of the recipient of credit.
 - Credit distributed should not exceed the credit available for distribution.
 - Tax paid on input services used by a particular location (registered as supplier), is to be distributed only to that location.
 - Credit of tax paid on input service used by more than one location who are operational is to be distributed to all of them based on the pro rata basis of turnover of each location in a State to aggregate turnover of all such locations who have used such services.

Note: The period to be considered for computation is the previous financial year of that location. If it does not have any turnover in the previous financial year, then previous quarter of the month to which the credit is being distributed.

- (ix) For a detailed discussion on Tax invoice or Credit note to be issued by an ISD reference maybe made to Chapter VII. The said Chapter VII clearly indicates the particulars to be included in such a document.

Illustration 1: A Ltd as an ISD has input service credit of ₹ 35 lakhs used by more than one locations, to be distributed among recipients locations X, Y and Z. The turnover of X, Y, Z in preceding financial year, is ₹ 10 crores, ₹ 15 crores and ₹ 5 crores respectively. The credit of ₹ 5 lakhs pertains to input service received only by Z. The credit attributable to X, Y, Z are as follows:

Particulars	Amount (in ₹)
Total Credit to be distributed as ISD	35 Lakhs
Credit of service used only by Z location	5 Lakhs

Credit available for distribution for all units	30 Lakhs
Credit distributable to X 10 crores / 30 crores * 30 Lakhs	10 Lakhs
Credit distributable to Y 15 crores / 30 crores * 30 Lakhs	15 Lakhs
Credit distributable to Z 5 crores / 30 crores * 30 Lakhs = 5 Lakhs Credit directly attributable to Z = 5 Lakhs	10 Lakhs

Illustration 2: Distribution of input tax credit by an ISD to its units is shown as under:

M/s XYZ Ltd, having its head Office at Delhi, is registered as ISD. It has three units in different State namely 'Delhi', 'Jaipur' and 'Gujarat' which are operational in the current year. M/s XYZ Ltd furnishes the following information for the month of July 2018 & asks to distribute the credit to various units.

- (i) CGST paid on services used only for Delhi Unit: ₹ 300000/-
- (ii) IGST, CGST & SGST paid on services used for all units: ₹ 1200000/-
- (iii) Total Turnover of the units for the Financial Year 2017-18 are as follows:-

Unit	Turnover (₹)
Delhi	5,00,00,000
Jaipur	3,00,00,000
Gujarat	2,00,00,000
Total	10,00,00,000

Solution: Computation of Input Tax Credit Distributed to various units: -

Particulars	Total Credit Available	Delhi	Jaipur	Gujarat
		Credit distributed to all Units		
CGST paid on services used only for Delhi Unit.	300000	300000	0	0
IGST, CGST & SGST paid on services used in all units- Distribution on pro rata basis to all the units which are operational in the current year (Refer Note1)	1200000	600000	360000	240000
Total	1500000	900000	360000	240000

Note 1: Credit distributed pro rata basis based on the turnover of all the units are as under: -

- (a) Unit Delhi: $(50000000/100000000)*1200000 = ₹ 600000$
- (b) Unit Jaipur: $(30000000/100000000)*1200000 = ₹ 360000$
- (c) Unit Gujarat: $(20000000/100000000)*1200000 = ₹ 240000$

Relevant period for distribution of credit:

- (a) If the recipient of credit has turnover in their State in preceding financial year of the year in which credit is distributed – Such financial year.
- (b) If some or all recipients do not have any turnover in their State in preceding financial year of the year in which credit is distributed – Last quarter for which details of such turnover of all the recipients are available, previous to the month during which credit is to be distributed.

The analysis of above provision in a pictorial form is summarised as follows:

Input Service Distributor – Sec. 20.

- ITC is distributed to supplier of goods or services or both of same entity having the same PAN as the ISD
- Common Services used at for

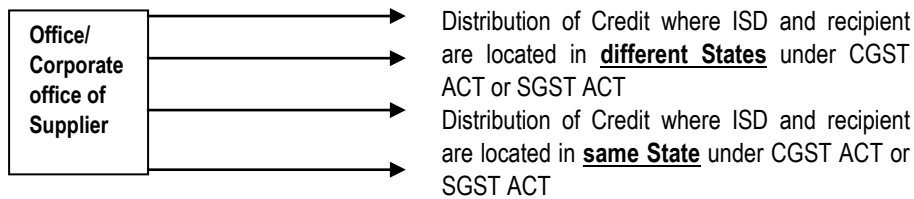

Input Service Distributor

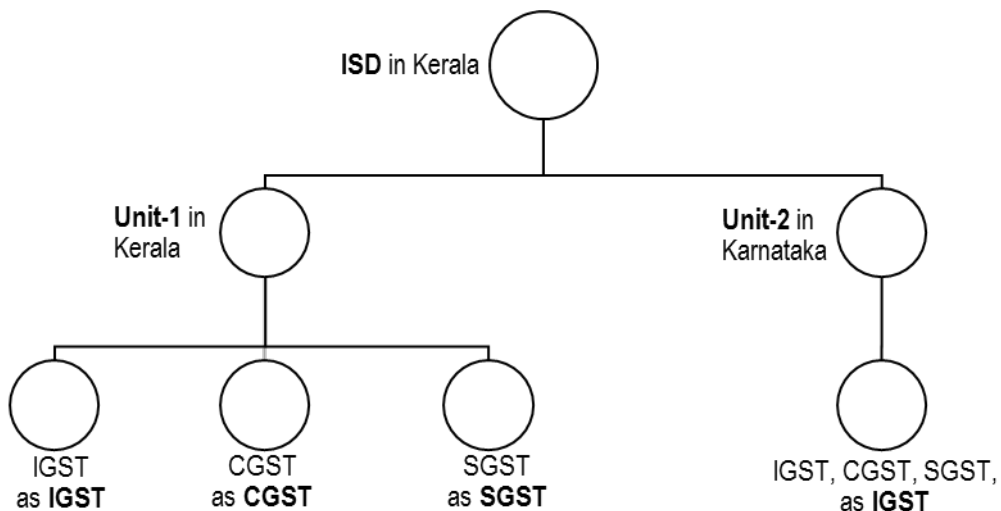

Illustration 3: Consider an example where a Company has a Branch-M in Mumbai and a Branch-D in Delhi. This Company is also incorporated in Delhi. Branch-M incurs various expenses that are supply of services in Delhi where CGST-SGST is liable to be charged in Delhi by that supplier. Obviously, credit of this tax cannot be availed by Branch-D because the underlying expense is not 'in relation to business' of Branch-D because it is exclusively in relation to business of Branch-M. When credit cannot be claimed by Branch-D and Branch-M does not want to forego this credit, the option available is for Branch-M to obtain ISD registration in Delhi. Now, in exactly, the same manner, if Branch-M incurs expenses in Maharashtra (say in Nasik), the implications would be that credit not allowable to Branch-M for these supplies and Branch-D is eligible to obtain ISD registration in Maharashtra, if credit is not to be foregone.

From this example, the following questions arise for careful consideration:

Question	Response
(i) Is ISD registration required in 'all but one' States for a registered taxable person? (All but one may all States/UT other than Home State)	Yes. If tax charged by the supplier is not IGST but CGST-SGST of the host-State where supplies are taking place, then a registered taxable person would require ISD registration in each those host-States except home-State
(ii) Is ISD registration an entity-level office in a given State or is it a registered taxable persons-specific office in other States (outside the home State of that registered taxable person)?	Yes, ISD is an entity-level office because section 2(61) defines ISD as "... means an office of the supplier which receives tax invoice...." It does not say it is an "office of the registered taxable person which receives tax invoice...."
(iii) Will ISD registration be required for each registered taxable person in 'all but one' States? (All but one may all States/UT other than Home State)	No. One entity-level ISD registration in all States will suffice for credit distribution requirement of all registered taxable persons having same PAN
(iv) Can an ISD distribute credit of taxes paid in that State alone (whether IGST or CGST-SGST) to registered taxable persons in all other States or only to that State for whose benefit the ISD registration was obtained?	Since ISD is an entity-level registration, one ISD in a State can distribute credit to all registered taxable persons in all other States having same PAN. Further, this ISD can also distribute credit to separately registered business verticals in that same State
(v) When GSTIN registration is obtained in	Yes, GSTIN registration does not permit

<p>one State, is there any need to also obtain ISD in the same State or is GSTIN and ISD registrations mutually exclusive in a given State?</p>	<p>distribution of credit. If taxes are paid that is not related to the business of that registered taxable person in that State, then for want of 'nexus', credit cannot be availed by him. And to save from loss of credit, ISD registration is the only option to distribute this credit whichever registered taxable person (called 'recipient of credit') satisfies this nexus test.</p>
<p>(vi) Can a Company who has independent operations in all 29 States and 2 UTs and is therefore registered in all 31 locations also be required to have 31 ISD registrations?</p>	<p>Yes, the Company could opt to do so.. This is because each registered taxable person stated to be truly independent of other business (of registered taxable persons) and receives supplies in those host-States where CGST-SGST paid in those host-States is to be distributed to the relevant home-State</p>
<p>(vii) Is it possible, when GSTIN registration is already available in any given State, for the Company to completely avoid ISD registration?</p>	<p>No, for the reasons stated in (vi) & (i) above, it would not be possible to avoid ISD registration</p>
<p>(viii) If a Company, to avoid ISD compliances, decides to avoid ISD registration in every State where it is already having GSTIN registration?</p>	<p>It is possible that a Company may consider the possibility of doing so subject to loss of legitimate credits which could have been availed as an ISD</p>
<p>(ix) If a Company were to instruct all registered taxable persons in a State who may have credit loss in other States misdirect the suppliers into issuing tax invoice with GSTIN of that State?</p>	<p>Yes, it is possible for a Company to misdirect a supplier. This supplier would only look for genuine GSTIN and similarity of name. It is not the supplier's responsibility to examine 'nexus' while issuing tax invoice</p>
<p>(x) Is ISD registration, therefore, necessary in every State where this 'nexus' test cannot be fulfilled by each registered taxable person?</p>	<p>Yes, as explained in (vii) above, ISD registration is necessary in every State where 'nexus' test is not fulfilled</p>
<p>(xi) Therefore, if multiple ISD registrations or GSTIN-plus-ISD registrations are unavoidable (as explained above), is there any solution to resolve this multiplicity of monthly and quarterly</p>	<p>Yes, only if 'link is established between the 'no nexus' supplies in a State and the registered taxable person in that same State. If no such 'nexus' exists, credit claim by registered taxable person becomes</p>

compliances?	improper. If nexus is established, please examine valuation of inter-branch supply of services is as per proviso to Rule 28 or as per Rule 30 of Central Goods and Service Tax Rules, 2017 relating to Valuation.
--------------	---

ISD is not merely a matter of compliance but involves great revenue implications to a registered taxable person. Compliance would also not be nominal. So, this is yet another indicator that the business model that has been in place until now has reached end-of-life and a new model needs to be examined. Please consider the following example of a CA in practice with branches in 3 States where the facts are as follows:

Common facts for consideration:	
Head office	Maharashtra
Branch offices	West Bengal and Delhi
Client base	All 3 States
Skills based	Distributed in all offices, based on the assignment, staff from all offices join to complete the assignment
Completion	Sign-off only by Partners who are in Maharashtra and West Bengal

Business models and their comparison are as follows:

Criteria	Under Erstwhile Law	Under GST Law – A	Under GST Law – B
ST (GST) registration	Centralized at Mumbai	All 3 branches	All 3 branches
Billing to clients	From all 3 offices	From Mumbai only	From all 3 offices
Internal billing	None	Branches issue tax invoice to HO at 'cost plus 10%' as per Rule 30 of Central Goods and Service Tax Rules, 2017 relating to Valuation	Every branch including HO to bill each other for their respective contribution on 'revenue split' or 'proportion of contribution' method
ST credit of branches	Availed at Mumbai due to centralized registration (ISD registration not required)	Branches and HO avail input tax credit on tax invoices issued by respective suppliers	Branches and HO avail input tax credit on tax invoices issued by respective suppliers including internal bills

ST credit at HO	Mumbai credits, entity-level credits and branch-specific credits	HO retains credit of all entity-level credits and avails credit of tax invoice issued by branches	HO retains credit of all entity-level credits
Loss, cost or risk	None	IGST outflow on non-credit costs included in valuation and 10% mark-up. Non-credit costs of branches are salaries, depreciation, etc.	Nexus risk on credits: <ul style="list-style-type: none"> entity-level costs like audit fee central vendor bills like data-telecom, travel, etc. Administrative challenge in assignment-level billing allocation
Mitigation	NA	Branch to invoice HO on 30 th in respect of client-level billings due on 1 st of next month so that the incremental IGST outflow from HO to branches is recovered quickly	GST does not impose any 'one-to-one' correlation of credits. Entity-level credit can be contended to be allowed in HO. Assignment-level billing allocation left to each branch to self-regulate

There is no doubt that the above are not recommendations but case for comparative illustration regarding application of the law to a business and to highlight that it is impossible to continue the erstwhile business model in GST, at least in many sectors.

The illustrations considered in this section are matters to be considered for discussion/deliberations only and are not views envisaged. The reader may or may not agree with the views in the discussion in this Chapter/section.

20.3 Comparative review

These provisions are similar to the provisions contained in the Rule 7 of CENVAT credit rules for distribution of credit of input service by an ISD.

It appears that the distribution of credit among the recipients prescribed in CENVAT credit Rules has been continued in proposed GST law. The conditions for distribution of credit for each recipient also appear to be continued as before.

20.4 FAQs

Q1. Whether CGST and IGST credit can be distributed by ISD as IGST credit to units located in different States?

Ans. Yes. CGST credit can be distributed as IGST and IGST credit can be distributed as IGST by an ISD for the units located in different States.

Q2. Whether SGST credit can be distributed as IGST credit by an ISD to units located in different States?

Ans. Yes. ISD can distribute SGST credit as IGST for the units located in different States.

Q3. What are the conditions to be fulfilled by ISD to distribute the credit?

Ans. The conditions to be fulfilled by ISD to distribute credit are:

- (a) Credit distributed to recipient under prescribed documents, which is issued to each of the recipient of credit.
- (b) Credit distributed should not exceed the credit available for distribution.
- (c) Tax paid on input services used by a particular location (registered as supplier), to be distributed only to that location.
- (d) Credit of tax paid on input service used by more than one location who are operational is to be distributed to all of them based on the pro rata basis of turnover of each locations in a State to aggregate turnover of all such locations who have used such services.

Q4. What are the documents through which the credit can be distributed by ISD?

Ans. An ISD can distribute credit to its recipient units by way of an ISD invoice prescribed in Rule 54 of the CGST Rules, 2017

Q5. How to distribute common credit among all the units of a ISD?

Ans. The common credit used by all the units can be distributed by ISD on pro rata basis i.e. based on the turnover of each unit to the aggregate turnover of all the units to which credit is distributed.

20.6 MCQs

Q1. The ISD may distribute the CGST and IGST credit to recipient outside the State as_____

- (a) IGST
- (b) CGST
- (c) SGST

Ans. (a) IGST

Q2. The ISD may distribute the CGST credit within the State as _____

- (a) IGST
- (b) CGST
- (c) SGST
- (d) Any of the above.

Ans. (b) CGST

Q3. According to the condition laid down for distribution of credit, ISD can distribute _____

- (a) Credit in excess of credit available
- (b) Only certain percentage of total credit available
- (c) Credit equal to the total credit available for distribution.
- (d) All of the above.

Ans. (c) Credit equal to the total credit available for distribution.

Q4. The credit of tax paid on input service used by more than one supplier is _____

- (a) Distributed among the suppliers who used such input service on pro rata basis of turnover in such State.
- (b) Distributed equally among all the suppliers
- (c) Distributed only to one supplier.
- (d) Cannot be distributed.

Ans. (a) Distributed among the suppliers who used such input service on pro rata basis of turnover in such State.

Statutory provisions

21. Manner of recovery of credit distributed in excess

Where the Input Service Distributor distributes the credit in contravention of the provisions contained in section 20 resulting in excess distribution of credit to one or more recipients of credit, the excess credit so distributed shall be recovered from such recipient(s) along with interest, and the provisions of section 73 or 74, as the case may be, shall mutatis mutandis apply for determination of amount to be recovered

Related Provisions of the Statute

Section or Rule	Description
Section 2(61)	Definition of 'Input Service Distributor'
Section 20	Manner of distribution of credit by Input Service Distributor
Section 73	Determination of tax not paid or short paid or erroneously

	refunded or input tax credit wrongly availed or utilised for any reason other than fraud or any wilful misstatement or suppression of facts.
Section 74	Determination of tax not paid or short paid or erroneously refunded or input tax credit wrongly availed or utilised by reason of fraud or any wilful misstatement or suppression of facts
Rule 65	Form and manner of submission of return by an Input Service Distributor

Relevant circulars, notifications, clarifications issued by Government:

1. Chapter Nineteen of the compilation of the GST Flyers as issued by the CBIC on 'Input Tax Credit Mechanism in GST'
2. Chapter Ten of the compilation of the GST Flyers as issued by the CBIC on 'Input Service Distributor in GST'

21.1 Introduction

The CGST Act clearly lays down that credit distribution is not 'to self', that is, a registered taxable person cannot distribute credit to himself. Each registered person being a distinct person u/s 25, must distribute to another registered taxable person but having the same PAN to whom the credit is most accurately attributable. And the consequence of incorrect distribution, due to inadvertence or misapplication of the provisions, are discussed here.

21.2 Analysis

(i) Excess Credit distributed in contravention of provision:

Excess credit distributed to one or more recipient of credit in contravention of ISD provision under Section 20 is recoverable from the recipient of such credit along with Interest. The recovery would be under the provisions of Section 73 or 74.

Example-1 Total Credit Available to ISD is 15,00,000/- & the credit distributed to all the units is ₹ 16,50,000/- (i.e. Delhi 10,00,000, unit Jaipur ₹ 4,00,000 & unit Gujarat ₹ 2,50,000). What will be the consequences?

Solution: The excess credit of 1,50,000 (₹ 16,50,000- ₹ 15,00,000) distributed would be recovered from the recipient along with interest and the provisions of section 73 or 74 shall apply mutatis mutandis for effecting such recovery.

Example-2 Total Credit Available to ISD is ₹ 15,00,000/- & the credit should have been distributed equal to all the units as all units had equal turnover, however credit distributed in violation of Section 21, as under:

Delhi ₹ 7,00,000, Jaipur ₹ 6,00,000, Gujarat ₹ 2,00,000.

What will be the consequences?

Solution: The excess credit of ₹ 2,00,000 (₹ 7,00,000- ₹ 5,00,000) shall be recovered from Delhi and ₹ 1,00,000 (₹ 600,000 – ₹ 5,00,000) shall be recovered from Jaipur along with interest and the provisions of section 73 or 74 shall apply mutatis mutandis for effecting such recovery.

The analysis of above provision in a pictorial form is summarised as follows:

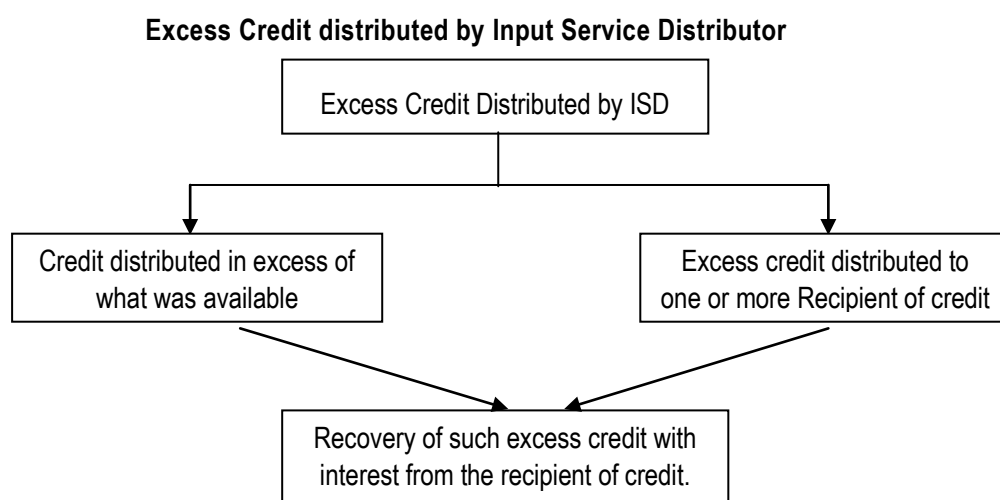

21.3 Comparative review

Earlier recovery provision was specified in Rule 14 of CENVAT Credit Rules. The CENVAT credit taken or utilized wrongly or has been erroneously refunded, was recovered along with interest under the provisions of sections 11A and 11AB of the Excise Act or sections 73 and 75 of the Finance Act.

Earlier, there was no specific provision for excess distribution of credit by ISD. Now specific provision is provided in the GST law providing for recovery of amount along with interest. Further, the relevant period for recovery of excess amount distributed is also provided in GST law.

21.4 FAQs

Q1. Whether the excess credit distributed could be recovered by the department?

Ans. Yes. Excess credit distributed could be recovered along with interest from recipient by the department.

Q2. What are the consequences of credit distributed in contravention of the provision of the Act?

Ans. The credit distributed in contravention of the provision of the Act is to be recovered from the unit to which it is distributed along with interest.

Chapter 7

Registration

Sections	Rules
22. Persons liable for registration	8. Application for registration
23. Persons not liable for registration	9. Verification of the application and approval
24. Compulsory registration in certain cases	10. Issue of registration certificate
25. Procedure for registration	11. Separate registration for multiple places of business within a State or a Union territory
26. Deemed registration	12. Grant of registration to persons required to deduct tax at source or to collect tax at source
27. Special provisions relating to casual taxable person and non-resident taxable person	13. Grant of registration to non-resident taxable person
28. Amendment of registration	14. Grant of registration to a person supplying online information and database access or retrieval services from a place outside India to a non-taxable online recipient
29. Cancellation or Suspension of registration	15. Extension in period of operation by casual taxable person and non-resident taxable person
30. Revocation of cancellation of registration	16. <i>Suo-moto</i> registration
	17. Assignment of Unique Identity Number to certain special entities
	18. Display of registration certificate and Goods and Services Tax Identification Number on the name board
	19. Amendment of registration
	20. Application for cancellation of registration

	<p>21. Registration to be cancelled in certain cases</p> <p>21A. Suspension of registration</p> <p>22. Cancellation of registration</p> <p>23. Revocation of cancellation of registration</p> <p>24. Migration of persons registered under the existing law</p> <p>25. Physical verification of business premises in certain cases</p> <p>26. Method of authentication</p>
--	--

Statutory Provisions- Effective from 1st July 2017 to 31st January 2019

22. Persons liable for registration

- (1) *Every supplier shall be liable to be registered under this Act in the State or Union territory, other than special category States, from where he makes a taxable supply of goods or services or both, if his aggregate turnover in a financial year exceeds twenty lakh rupees:*

Provided that where such person makes taxable supplies of goods or services or both from any of the special category States, he shall be liable to be registered if his aggregate turnover in a financial year exceeds ten lakh rupees.

- (2) *Every person who, on the day immediately preceding the appointed day, is registered or holds a licence under an existing law, shall be liable to be registered under this Act with effect from the appointed day.*
- (3) *Where a business carried on by a taxable person registered under this Act is transferred, whether on account of succession or otherwise, to another person as a going concern, the transferee or the successor, as the case may be, shall be liable to be registered with effect from the date of such transfer or succession.*
- (4) *Notwithstanding anything contained in sub-sections (1) and (3), in a case of transfer pursuant to sanction of a scheme or an arrangement for amalgamation or, as the case may be, demerger of two or more companies pursuant to an order of a High Court, Tribunal or otherwise, the transferee shall be liable to be registered, with effect from the date on which the Registrar of Companies issues a certificate of incorporation giving effect to such order of the High Court or Tribunal.*

Explanation. For the purposes of this section, —

- (i) *the expression “aggregate turnover” shall include all supplies made by the taxable person, whether on his own account or made on behalf of all his principals;*
- (ii) *the supply of goods, after completion of job work, by a registered job worker shall be treated as the supply of goods by the principal referred to in section 143, and the value of such goods shall not be included in the aggregate turnover of the registered job worker;*
- (iii) *the expression “special category States” shall mean the States as specified in sub-clause (g) of clause (4) of article 279A of the Constitution.*

Statutory Provisions- Effective from 1st February 2019 vide The Central Goods & Services Tax Amendment Act, 2018

22. Persons liable for registration

- (1) *Every supplier shall be liable to be registered under this Act in the State or Union territory, other than special category States, from where he makes a taxable supply of goods or services or both, if his aggregate turnover in a financial year exceeds twenty lakh rupees:*

Provided that where such person makes taxable supplies of goods or services or both from any of the special category States, he shall be liable to be registered if his aggregate turnover in a financial year exceeds ten lakh rupees.

Provided further that the Government may, at the request of a special category State and on the recommendations of the Council, enhance the aggregate turnover referred to in the first proviso from ten lakh rupees to such amount, not exceeding twenty lakh rupees and subject to such conditions and limitations, as may be so notified.

- (2) *Every person who, on the day immediately preceding the appointed day, is registered or holds a licence under an existing law, shall be liable to be registered under this Act with effect from the appointed day.*
- (3) *Where a business carried on by a taxable person registered under this Act is transferred, whether on account of succession or otherwise, to another person as a going concern, the transferee or the successor, as the case may be, shall be liable to be registered with effect from the date of such transfer or succession.*
- (4) *Notwithstanding anything contained in sub-sections (1) and (3), in a case of transfer pursuant to sanction of a scheme or an arrangement for amalgamation or, as the case may be, demerger of two or more companies pursuant to an order of a High Court, Tribunal or otherwise, the transferee shall be liable to be registered, with effect from the date on which the Registrar of Companies issues a certificate of*

incorporation giving effect to such order of the High Court or Tribunal.

Explanation. For the purposes of this section, —

- (iv) the expression “aggregate turnover” shall include all supplies made by the taxable person, whether on his own account or made on behalf of all his principals;*
- (v) the supply of goods, after completion of job work, by a registered job worker shall be treated as the supply of goods by the principal referred to in section 143, and the value of such goods shall not be included in the aggregate turnover of the registered job worker;*
- (vi) the expression “special category States” shall mean the States as specified in sub-clause (g) of clause (4) of article 279A of the Constitution except the State of Jammu & Kashmir and States of Arunachal Pradesh, Assam, Himachal Pradesh, Meghalaya, Sikkim and Uttarakhand.*

Extract of the CGST Rules, 2017

18. Display of registration certificate and Goods and Services Tax Identification Number on the name board.

- (1) Every registered person shall display his certificate of registration in a prominent location at his principal place of business and at every additional place or places of business.*
- (2) Every registered person shall display his Goods and Services Tax Identification Number on the name board exhibited at the entry of his principal place of business and at every additional place or places of business.*

Relevant circulars, notifications, clarifications, flyers issued by Government:

1. Chapter one of the compilation of the GST Flyers titled ‘Registration under GST Law’, as issued by the CBIC (erstwhile CBEC).
2. Notification No. 2/2019-Central Tax, dated 29-Jan-2019, seeks to bring in force Central Goods and Services Tax (Amendment) Act, 2018, w.e.f. 1-Feb-2019

Related provisions of the Statute:

Section or Rule	Description
Section 2(6)	Definition of “aggregate turnover”
Section 24	Compulsory registration
Section 25	Procedure for registration

22.1 Introduction

This section provides for registration of every supplier effecting taxable supplies, subject to a threshold limit. Registration of a business with the tax authorities implies obtaining a unique identification code (i.e. GSTIN) from the concerned tax authorities so that all the operations of, and data relating to the business can be agglomerated and correlated. In any tax system, this is the most fundamental requirement for identification of the business for tax purposes and for having any compliance verification mechanism. A registration from the concerned tax authorities will confer, among others, the following advantages to the registrant.

- Legally recognised as a supplier of goods and/or services;
- Proper accounting of taxes paid on the input goods and/ or services;
- Utilisation of input taxes for payment of GST due on supply of goods and/ or services;
- Pass on the credit of the taxes paid on the goods and/ or services supplied to purchasers or recipients.

22.2 Analysis

- Every supplier shall be liable to be registered under the Act in the State from which he makes a taxable supply of goods or services or both. **It is important to note that registration is required 'in' the State 'from which' taxable supplies are made.** Registration is not required 'in' the State 'to' which taxable supplies are made, even though this is a destination-based tax. This greatly reduces the burden of the taxable person from having to seek registration in every State 'to' which taxable supplies are made. If the supplies are 'to' another State, then the nature of tax will not be CGST-SGST but IGST and is paid to the Centre who will ensure that the same reaches the appropriate 'destination' State. Therefore, for purposes of obtaining registration, it is important to identify the 'origin' of supply even though GST is a 'destination' based tax. Tax goes to the destination-State but registration is in the origin-State. Place of Supply (as determined from IGST Act) provides the 'destination' and this is not relevant for registration. The location of Supplier is relevant for registration.

The State "from" where taxable supply is made is a question of fact and that must be determined based on the requirement of law. In the case of services, location of Supplier of services is defined in section 2(71) of CGST Act but in the case of goods, location of Supplier of goods is not defined. And this is not an oversight but deliberate. Services leave no trail as to the location 'from' where they are supplied and for that reason, a definition is required. Whereas goods leave a trail, that is, where the goods are actually 'located'. This can be seen from the definition of Place of Business [Section 2(85)] of CGST Act. **Place of Business** is where business is 'ordinarily carried on' – this would be the location 'from' where taxable supplies are made, whether for goods or for services. But, if this is not (in case of goods), this definition goes on to include 'place where goods are stored'. Hence, location of Supplier of goods is where

business is ordinarily carried on or where the goods themselves are located, if that were more accurate. *For example*, a company incorporated outside India purchases goods from a manufacturer and instructs that the goods be deposited with a warehouse-keeper in India. And then after some time, supplies the goods from the warehouse to a customer also within India. By being incorporated outside India, the place where business is ordinarily carried on is not in India but the location where goods are stored being within India, attracts the requirement to register at the warehouse. It is true that mere storage is not the 'place of business' in general understanding but in GST this appears to the unequivocal intent of the law-maker. Care should be taken to correctly identify where registration ought to be obtained so as not to end up with a serious misapplication of the requirements of law.

At this point, it would also be relevant to note the difference in sections 22(1) of CGST Act when compared with sections 22(1) of any State GST Act:

Section 22(1) of the CGST Act	Section 22(1) of any SGST Act
<i>Every supplier shall be liable to be registered under this Act in the State or Union territory, other than special category States, from where he makes a taxable supply of goods or services or both, if his aggregate turnover in a financial year exceeds twenty lakh rupees</i>	<i>Every supplier making a taxable supply of goods or services or both in the State shall be liable to be registered under this Act if his aggregate turnover in a financial year exceeds twenty lakh rupees</i>

Comparison of the provisions:

Point of Difference	CGST Act	SGST Act
Applicable to	<i>Every supplier</i>	<i>Every supplier</i>
Responsibility	<i>shall be liable to be registered under this Act</i>	<i>shall be liable to be registered under this Act</i>
Jurisdiction	<i>in the State or Union territory from where</i>	<i>in the State</i>
Exception	<i>other than special category States</i>	
Activity	<i>makes a taxable supply of goods or services or both</i>	<i>making a taxable supply of goods or services or both in the State</i>
Criteria	<i>if his aggregate turnover in a financial year exceeds twenty lakh rupees</i>	<i>if his aggregate turnover in a financial year exceeds twenty lakh rupees</i>

Given the difference in sections 22(1) of CGST and SGST Act, one may argue that based on the provisions of SGST Act, the registration is required “in the State” where the supply has been executed and not “from” the State and that if the intention was to require registration based on the “from” State then the provisions of SGST Act should have mirrored the provisions of CGST Act.

Registration is required if the aggregate turnover in a financial year exceeds rupees twenty lakhs. This threshold limit will be rupees ten lakhs if a taxable person conducts his business in any of the special category States as specified in sub-clause (g) of clause (4) of Article 279A of the Constitution. However, vide CGST (Amendment) Act, 2018 second proviso to section 22(1) has been inserted to provide that Government may, at the request of a special category State and on the recommendations of the Council, enhance the aggregate turnover referred to in the first proviso from ₹ 10 lakh to such amount, not exceeding ₹ 20 lakh and subject to such conditions and limitations, as may be so notified. Accordingly, threshold limit remains rupees twenty lakhs for the States of Jammu and Kashmir, Arunachal Pradesh, Assam, Himachal Pradesh, Meghalaya, Sikkim and Uttarakhand w.e.f. 1-Feb-2019 and rupees ten lakhs for the States of Manipur, Mizoram, Nagaland and Tripura.

How the Aggregate Turnover is calculated?

The expression “aggregate turnover” has been defined under section 2(6) of the CGST Act (please refer Chapter 1 of the BGM for discussion for the scope and coverage of the term “aggregate turnover”). Aggregate Turnover is PAN based and not State/ Union Territory based.

In the below table, illustrations have been provided to understand how aggregate turnover is calculated and what will be the requirement of registration in each of these illustrations-

Illustration 1

State	Turnover	Registration Requirement
Maharashtra	15,00,000	Since the turnover of the entire entity exceeds ₹ 20,00,000, (15,00,000+7,00,000) registration will be required in both the States
Tamil Nadu	7,00,000	

Illustration 2

State	Turnover	Registration Requirement
Maharashtra	9,00,000	Since the entity has presence in special category State, the threshold limit is only Rs.10,00,000. Since the entity crosses such limit, registration will be required in both the States*
Manipur Tripura	2,00,000	

* Please note that the *proviso* to section 22(1) appearing in CGST Act also appears in SGST Act(s). As a result, for a taxable person in a non-Special Category State, who has a branch in Special Category State, the threshold becomes 10 lacs and not 20 lacs.

- Registration requirements under the pre GST Laws-

Statute	Registration Requirement	Registration Level
Excise	For each factory	Unit Level
VAT	Per State (branches in the State were considered as additional places of business)	State Level
Service Tax	One centralized registration (option for de-centralized registration was also available)	National Level

- GST has adopted VAT model for registration. Hence, the supplier will be liable to obtain registration for each of the locations spread across various States/ Union territories, though he operates as a single person for the purpose of other statutes like Companies Act, 2013, Income Tax Act, 1961 etc.
- A proper reading of section 22 read with section 25 helps us to understand that a State is the smallest registrable unit in GST – and multiple places of registrations can also be taken separately in one particular state if the conditions specified in rule 11 are satisfied.
- For calculating the threshold limit, the turnover shall include all supplies made by the taxable person, whether on his own account or made on behalf of all his principals. Further, supply of goods by a registered job worker, after completion of job work, shall be treated as the supply of goods by the “principal” referred to in section 143 (i.e. Job work procedure) of this Act. The value of such goods shall not be included in the aggregate turnover of the registered job worker.
- It is necessary to appreciate the difference between ‘person’ and ‘taxable person’. Person is defined in section 2(84) of CGST Act to include various types of business structures and association of persons whereas taxable person is defined in section 2(107) to mean a person who is registered or is under obligation to get register under GST.

Exemption Limit vs. Registration Limit

In the erstwhile law the facility of SSI/ SSP exemptions were provided wherein even though assessee has taken the registration it was not required to collect and pay tax unless they crossed the threshold limit. However, in GST regime no such exemption is provided under the law. Once registration is taken the taxpayer is mandatorily required to collect and pay tax to the Government irrespective of threshold. As per sections 2(107) of the CGST Act, 2017 “*taxable person*” means a person who is registered or liable to be registered under section 22

or section 24; this means a registered person is a taxable person. It is important to note that section 9 of CGST Act, 2017 imposes liability to taxable person and, therefore, once registration is obtained the concept of taxable person gets triggered.

Other persons requiring registration under this provision – irrespective of threshold limit

- Every person who, on the day immediately preceding the appointed day, is registered or holds a license under an earlier law, shall be liable to be registered under this Act with effect from the appointed day.

Based on this provision, all the persons registered under the prep GST law were mandatorily required to migrate to GST and then the option for cancellation of registration was provided.

- Transfer of business – Detailed below.

Transfer of Business and Registration

If a registered taxable person transfers business on account of succession or otherwise, to another person as a going concern, the transferee, or the successor, as the case may be, shall be liable to be registered with effect from the date of such transfer or succession. This means that the Registration Certificate issued under sections 22 of the Act is not transferable to any other person. In a case of transfer pursuant to sanction of a scheme or an arrangement for amalgamation or, as the case may be, de-merger of two or more companies by an Order of a High Court, the transferee shall be liable to be registered with effect from the date on which the Registrar of Companies issues a certificate of incorporation giving effect to such Order of the High Court.

Obligations after registration

- As per rule 18, every registered person shall display his Certificate of Registration in a prominent location at his principal place of business and at every additional place or places of business.
- Every registered person shall display his Goods and Services Tax Identification Number on the name board exhibited at the entry of his principal place of business and at every additional place or places of business.

Issues/ Concerns

- (a) Requirement of registration in respect of construction works undertaken outside the State: Works contractors, having a principal place of business in one State may undertake execution of works across India in many States. It may so happen that the contractor procures and or stores his goods at the site (in another state) and thereafter carries on the construction work at the site. Alternatively, it may also happen that the contractor does not keep any of his goods at the site and merely

Now, as per section 2(85), a “place of business” is defined “...to include any other place, where a taxable person stores his goods or receives goods or services...” Hence, in

case the taxable person stores his goods at the construction site, it will be considered as his place of business and he will be liable to take registration at the construction site.

Statutory provisions

23. Persons not liable for registration

- (1) *The following persons shall not be liable to registration, namely: —*
- (a) *any person engaged exclusively in the business of supplying goods or services or both that are not liable to tax or wholly exempt from tax under this Act or under the Integrated Goods and Services Tax Act;*
 - (b) *an agriculturist, to the extent of supply of produce out of cultivation of land.*
- (2) *The Government may, on the recommendations of the Council, by notification, specify the category of persons who may be exempted from obtaining registration under this Act.*

Relevant circulars, notifications, clarifications, flyers issued by Government: -

1. Notification No. 5/2017–Central Tax, dated 19.06.2017 regarding exemption from registration to persons engaged only in making taxable supplies where total tax is liable to be paid on reverse charge basis.
2. Notification No. 65/ 2017–Central Tax, dated 15.11.2017 regarding exemption from compulsory registration to suppliers of services through an e-commerce platform where aggregate turnover is not exceeding ₹ 20 lakhs.
3. Notification No. 56/2018-Central Tax, dated 23.10.2018 seeks to supersede Notification No. 32/2017-Central Tax, dated 15.09.2017 and specifies categories of casual taxable persons making taxable supplies of handicraft goods having aggregate turnover upto ₹ 20 lakhs who shall be exempted from obtaining registration.
4. Notification No. 7/2017–Integrated Tax, dated 14.09.2017 as amended vide Notification No. 2/2019-Integrated Tax, dated 29-Jan-2019, w.e.f. 1-Feb-2019, regarding exemption from registration to job-workers making inter-State supply of services to a registered person where aggregate turnover is not exceeding ₹ 20 lakhs.
5. 10/2017–Integrated Tax, dated 13.10.2017 as amended vide 3/2019-Integrated Tax, dated 29-Jan-2019, w.e.f. 1-Feb-2019, regarding exemption from registration to persons making inter-State supplies of taxable services where turnover is not exceeding ₹ 20 Lacs
6. Notification No. 3/2018-Integrated Tax, dated 22.10.2018 seeks to supersede Notification No. 8/2017-Integrated Tax, dated 14.09.2017 and specifies categories of persons making inter-State taxable supplies of handicraft goods and having aggregate turnover upto ₹ 20 lakhs who shall be exempted from obtaining registration.

7. Notification No. 10/2019-Central Tax, dated 07.03.2019 seeks to give exemption from registration for any person engaged in exclusive supply of goods and whose aggregate turnover in the financial year does not exceed Rs 40 lakhs. [w.e.f. 01.04.2019]
8. Advance Ruling under the West Bengal GST Act, 2017 regarding non-requirement of registration where a person is engaged exclusively in supply of exempt goods/ services except where he is otherwise liable to pay tax under reverse charge basis under section 9(3) or 5(3) of CGST Act/ IGST Act, 2017.
9. Chapter one of the compilation of the GST Flyers titled 'Registration under GST Law', as issued by the CBIC (erstwhile CBEC).

Related provisions of the Statute

Section or Rule	Description
Section 2(7)	Definition of 'agriculturist'
Section 2(47)	Definition of "exempt supply"
Section 25	Procedure for registration

23.1 Analysis

Section 23 provides relaxation from the requirement of obtaining registration to two categories of persons

- (a) Agriculturist;
- (b) Persons engaged exclusively in the supply of exempted goods or services or both.

Thus, the aforementioned persons would not be required to obtain registration even if their turnover exceeds ₹ 20 Lakhs. To this extent, section 23 overrides the provisions of section 22.

Agriculturist

As per section 2(7), agriculturist means an individual or HUF who undertakes cultivation of land:

- (a) By own labour, or
- (b) By the labour of family, or
- (c) By servants on wages payable in cash or kind or by hired labour under personal supervision or the personal supervision of any member of the family.

Thus, an agriculturist is not liable for registration only to the extent of supply of produce out of cultivation of land. If an agriculturist undertakes supplies which are not linked to the cultivation of land, he will fall within the provisions of sections 22 and may have to take registration in respect of such supplies. It is important to consider the nature of activities undertaken by the agriculturist. If the process deviates from 'cultivation' it will travel outside the scope of this exclusion from registration. The exclusion states – to the extent of supply of 'produce out of

cultivation' of land – any further processing of the primary produce from cultivation will continue not to avail this exclusion.

Cultivation of land does not include pisciculture on inland water body or cattle rearing that graze the produce of land. The produce that emerge from land is 'cultivation of land'. For example, harvesting paddy is cultivation but production of rice is not.

Please note that the exclusion from the requirement to be registered does not result in non-collection of tax on agricultural produce. Section 9(3) of the CGST Act and sections 5(3) of the IGST Act notifies certain commodities (like cashew nuts) on which tax is required to be discharged under reverse charge basis by the recipient of goods when such commodities are purchased from an agriculturist. Thus, the exemption from registration is dependent on status of the supplier and not based on the commodity involved. Needless to say, if the supplier of goods is not an agriculturist, then he will have to obtain registration under the regular provisions sections 22 if his aggregate turnover exceeds ₹ 20 Lakhs.

Exclusively engaged in Exempt Supplies

The term exclusive indicates engaging in only those supplies which are exempted. Therefore, if a supplier is supplying both exempted and non-exempted goods and/or services, then this provision is not applicable, and he is required to obtain registration under sections 22.

Further, this section also permits any person whose 'entire' supply consists of 'exempt supplies', then such person is excluded from obtaining registration. Care should be taken to validate the premises about (a) entire supply and (b) exempt. Even if small value of supplies is taxable, then even exempt supplies will be included to determine if aggregate turnover has exceeded the threshold limit under section 22 for attracting registration.

Now, a question may arise as to whether registration is required in case a person is engaged exclusively in supplying exempted goods or services and also incurs certain expenses which are listed in section 9(3) as Reverse charge items.

For example: Mr. Akshay is engaged in exclusive supply of exempted goods (say puja samagri) and has a turnover of ₹ 50 crores. He also pays transportation charges to a GTA. Whether Mr. Akshay will be required to take registration? Now, to answer this question, we should take a note that registration requirement for payment of tax under RCM is specified in section 24, which starts with a non-obstante clause and overrides section 22(1) [*cases of registration where aggregate turnover exceeds ₹ 20/10 lakhs*] and it does not override section 23 [*which grants exemption from liability to register*]. So in case a person is exempted from obtaining registration u/s. 23 (and its notifications), he cannot be made liable for registration u/s. 24 till the time he continues to satisfy the conditions of section 23. Further, a person who only supplies exempted goods cannot be covered by section 22(1), because section 22(1) mandates registration in the state, from where a person **makes taxable supply** of goods or services. However, the department may contend otherwise and this issue needs to be litigated based on merits.

Engaged

Notified persons may also be granted an exemption from registration. In this regard, the Government has exempted the following persons from obtaining registration:

- (a) Persons engaged in rendering taxable services which are liable to GST under reverse charges are not required to take registration - (*Notification No. 5/2017–Central Tax, dated 19.06.2017*)
- (b) Job-workers engaged in making inter-State supply of services to a registered person except those who are liable to be registered under section 22(1) of the CGST Act, 2017 or persons opting for voluntary registration or persons engaged in making supply of services in relation to jewellery, goldsmiths' and silversmiths' wares and other articles (w.e.f. 14.09.2017) - *Notification No. 7/2017–Integrated Tax, dated 14.09.2017* as amended vide Notification No. 2/2019-Integrated Tax, dated 29-Jan-2019, w.e.f. 1-Feb-2019.
- (c) Persons effecting inter-State supplies of taxable services – where the aggregate value of supplies on PAN-India basis does not exceed ₹ 20 Lakhs in a year (₹ 10 Lakhs for special category States- Manipur, Mizoram, Nagaland and Tripura) (w.e.f. 13.10.2017) - *Notification No. 10/2017–Integrated Tax, dated 13.10.2017* as amended vide Notification No. 3/2019-Integrated Tax, dated 29-Jan-2019, w.e.f. 1-Feb-2019.
- (d) Categories of persons effecting inter-State taxable supplies of handicraft goods – where the aggregate value of supplies on PAN-India basis does not exceed ₹ 20 Lakhs in a year (₹ 10 Lakhs for special category States- Manipur, Mizoram, Nagaland and Tripura) - (w.e.f. 22.10.2018) - *Notification No. 3/2018–Integrated Tax dated 22.10.2018*. This notification has superseded Notification No. 8/ 2017-Integrated Tax, dated 14.09.2017
- (e) Persons providing services through an e-commerce who is required to collect tax at source, provided their aggregate turnover does not exceed ₹ 20 lakh (₹ 10 lakh in special category States-Manipur, Mizoram, Nagaland and Tripura) (w.e.f. 15.11.2017). - *Notification No. 65/2017–Central Tax, dated 15.11.2017* as amended vide Notification No. 6/2019-Central Tax, dated 29-Jan-2019, w.e.f. 1-Feb-2019
- (f) Categories of casual taxable persons making taxable supplies of handicraft goods-where the aggregate value of supplies on PAN-India basis does not exceed ₹ 20 Lakhs in a year (₹ 10 Lakhs for special category States-Manipur, Mizoram, Nagaland and Tripura) - (w.e.f. 23.10.2018) – *Notification No. 56/2018-Central Tax, dated 23.10.2018*. This notification has superseded Notification No. 32/ 2017-Central Tax, dated 15.09.2017.
- (g) **W.e.f. 01.04.2019** – the basic limit beyond which obtaining registration becomes mandatory is increased from ₹ 20 lakhs to ₹ 40 lakhs for certain categories of persons vide notification No. 10/2019-Central Tax, dated 07.03.2019.

As per the said notification, any person, who is engaged in **exclusive supply of goods** and whose aggregate turnover in the financial year does not exceed forty lakh rupees, except, -

- (a) persons required to take compulsory registration under section 24 of the said Act;
- (b) persons engaged in making supplies of the following goods,;

Sl. No.	Tariff item, sub heading, heading or Chapter	Description
1	2105 00 00	Ice cream and other edible ice, whether or not containing cocoa
2	2106 90 20	Pan masala
3	24	All goods, i.e. Tobacco and manufactured tobacco substitutes

- (c) persons engaged in making intra-State supplies in the States of Arunachal Pradesh, Manipur, Meghalaya, Mizoram, Nagaland, Puducherry, Sikkim, Telangana, Tripura, Uttarakhand; and
- (d) persons exercising option under the provisions of sub-section (3) of section 25 [voluntary registration], or such registered persons who intend to continue with their registration under the said Act.

Therefore,

Issues/ Concerns:

- (a) The new exemption from registration (w.e.f. 01.04.2019) upto ₹ 40 lakhs is applicable only for those taxable persons, who are engaged in exclusive supply of goods. Therefore, in case a person is supplying goods but also earns a nominal amount of service income (*whether taxable or not*) such as commission income, or interest income say from bank (*which is exempt*), then he shall be liable to take registration above ₹ 20 lakhs and not ₹ 40 lakhs.
- (b) Exemption to Charitable Organizations: Pursuant to Notification No. 12/2017-Central Tax (Rate), dated 28th June, 2017, the Government has exempted services by way of charitable activities, provided by charitable organisations from the levy of GST. Thus, charitable organizations engaged exclusively in charitable activities are exempted from obtaining registration. However, charitable organisations are compelled to register where they have receipts on account of ancillary activities like providing a shop on rent to outsider (so that the visitors get tea and food), charitable hospitals running pharmacy and providing medicines at concessional rate or free of cost etc, as these are taxable supply and thus liable for registration.

- (c) Separate Registration for ISD to discharge tax on RCM basis: Under the erstwhile Service Tax laws, an ISD was allowed to discharge tax liability under reverse charge mechanism without seeking a separate registration. However, under GST regime, the ISD is required to obtain a separate GSTIN other than the ISD registration for discharging such taxes. But, an ISD is not one who will have any taxable outward supplies except distribution of credit. When an ISD attracts RCM or other liability of its own, then it is more likely that the ISD will become a regular taxable person because of these taxable inward supplies cannot be received without creating outward supply event. This is adding to the multiplicity of registrations and complexity in documentation and compliance and impacting the matrix of 'ease of doing business'.
- (d) Inclusion of non-operational income for threshold limit: The inclusion of non-operational income like interest income as 'exempt supplies' for the purpose of determining the aggregate turnover for registration would bring into the forte a huge number of persons who are otherwise undertaking only a minimal amount of supply. In case a person is earning interest income from Fixed Deposit Receipts (FDR) of ₹ 15 Lakhs and a rental income from renting of immovable property of ₹ 6 Lakhs, he would need to take registration and collect GST on such supply of rental services.

Statutory Provisions

24. Compulsory registration in certain cases

- (1) *Notwithstanding anything contained in sub-section (1) of section 22, the following categories of persons shall be required to be registered under this Act, —*
- (i) *persons making any inter-State taxable supply;*
 - (ii) *casual taxable persons making taxable supply;*
 - (iii) *persons who are required to pay tax under reverse charge;*
 - (iv) *person who are required to pay tax under sub-section (5) of section 9;*
 - (v) *non-resident taxable persons making taxable supply;*
 - (vi) *persons who are required to deduct tax under section 51, whether or not separately registered under this Act;*
 - (vii) *persons who make taxable supply of goods or services or both on behalf of other taxable persons whether as an agent or otherwise;*
 - (viii) *Input Service Distributor, whether or not separately registered under this Act;*
 - (ix) *persons who supply goods or services or both, other than supplies specified under sub-section (5) of section 9, through such electronic commerce operator who is required to collect tax at source under section 52;*

- (x) every electronic commerce operator who is required to collect tax at source under section 52¹;
- (xi) every person supplying online information and database access or retrieval services from a place outside India to a person in India, other than a registered person; and
- (xii) such other person or class of persons as may be notified by the Government on the recommendations of the Council.

Relevant circulars, notifications, clarifications, flyers issued by Government:

1. Notification No. 2/2019-Central Tax, dated 29-Jan-2019, seeks to bring in force Central Goods and Services Tax (Amendment) Act, 2018, w.e.f. 1-Feb-2019
2. Chapter one of the compilation of the GST Flyers titled 'Registration under GST Law', as issued by the CBIC (erstwhile CBEC).
3. Circular No. 10/10/2017-GST, dated 18.10.2017 clarifying issues wherein the goods are moved within the State or from the State of registration to another State for supply on approval basis.
4. Circular No. 57/31/2018-GST, dated 4.09.2018 clarifying the scope of principal-agent relationship and requirement of registration of an agent.

Related provisions of the Statute:

Section or Rule	Description
Section 2(20)	Definition of "casual taxable person"
Section 2(47)	Definition of "exempt supply"
Section 9(5)	Tax on reverse charge basis to be paid by e-commerce operator
Section 22	Persons liable for registration
Section 25	Procedure for registration
Section 51	Tax Deduction at source
Section 52	Collection of tax at source

24.1 Analysis

Section 22 prescribes certain conditions, subject to fulfilment of which, registration must be obtained. However, sections 24 enlists 12 categories of persons who shall compulsorily obtain the registration, whether or not the provisions prescribed under section 22(1) are triggered in such cases. Section 24 begins with a non-obstante clause and is thus, an overriding section

¹ Inserted vide The Central Goods and Services Tax Amendment Act, 2018 w.e.f. 01.02.2019

that makes it mandatory for the prescribed persons to obtain registration even though the turnover conditions prescribed under section 22(1) are not fulfilled.

Categories of persons who shall be required to be registered under this Act irrespective of the threshold limit:

The following categories of persons are required to obtain registration compulsorily under this Act:

- Persons making any inter-State taxable supply;
- Casual taxable persons making taxable supply;
- Persons who are required to pay tax under reverse charge;
- Persons who are required to pay tax under sub-section (5) of section 9 (electronic commerce operator)
- Non-resident taxable persons making taxable supply;
- Persons who are required to deduct tax under section 51 (Tax Deduction at Source);
- Persons who supply goods or services or both on behalf of other registered taxable persons whether as an agent or otherwise;
- input service distributor;
- persons who supply goods and/or services, other than supplies specified under sub-section (5) of section 9, through such electronic commerce operator who is required to collect tax at source under section 52,
- Every electronic commerce operator **who is required to collect tax at source under section 52;**
- every person supplying online information and database access or retrieval services from a place outside India to a person in India, other than a registered taxable person; and
- Such other person or class of persons as may be notified by the Central Government or a State Government on the recommendations of the Council.

It may be noted that *vide* Notification 10/ 2017–Integrated Tax, dated 13th October 2017, persons making inter-States supply of services and having turnover not exceeding Rs. 20 lakhs have been exempted (*u/s. 23 as discussed in the above paragraphs*) from obtaining registration. Accordingly, only persons who make inter-State supply of goods have to compulsorily obtain registration irrespective of the all-India turnover.

However, the aggregate value of supply of services should not exceed Rs. 10 lakhs in respect of special category Special Category States except the States of Jammu and Kashmir, Arunachal Pradesh, Assam, Himachal Pradesh, Meghalaya, Sikkim and Uttarakhand.

The Government has issued notifications under section 23(2) to provide exemption from registration to certain category of persons who are mentioned in the aforementioned list. Details of such exemption are provided under sections 23(2) and implications of such exemption to those persons requiring compulsory registration is tabulated below:

Category of Persons	Exemption Granted
Persons making any inter-State taxable supply	Inter State supplies of taxable services (<i>Notification No. 10/2017–Integrated Tax, dated 13.10.2017 amended vide Notification No. 3/2019-Integrated Tax, dated 29-Jan-2019, w.e.f. 1-Feb-2019</i>) and handicraft goods except when their turnover exceeds threshold limit (<i>dated14Notification No.3/2018–Integrated Tax, dated22.10.2018 which superseded Notification No. 8/ 2017-Integrated Tax, dated 14.9.2017</i>)
Casual taxable persons making taxable supply	Casual taxable persons making taxable supplies of handicraft goods if the aggregate turnover does not exceed ₹ 20 lakhs(<i>Notification No. 56/2018-Central Tax, dated 23.10.2018 which superseded Notification No. 32/ 2017–Central Tax, dated 15.9.2017</i>)
Persons who are required to pay tax under reverse charge	
Persons who are required to pay tax under sub-section (5) of section 9 (electronic commerce operator)	
Non-resident taxable persons making taxable supply	
Persons who are required to deduct tax under section 51 (Tax Deduction at Source)	
Persons who supply goods or services or both on behalf of other registered taxable persons whether as an agent or otherwise	
Input Service Distributors	
Persons who supply goods and/or services, other than supplies specified under sub-	Supplier providing services through an e-commerce operator if the aggregate

section (5) of section 9, through such electronic commerce operator who is required to collect tax at source under section 52	turnover does not exceed ₹ 20 Lakhs (Notification No. 65/2017–Central Tax, dated 15.11.2017 amended vide Notification No. 6/2019-Central Tax, dated 29-Jan-2019, w.e.f. 1-Feb-2019)
Every electronic commerce operator who is required to collect tax at source under section 52	CGST (Amendment) Act, 2018 came into effect from 1-Feb-2019 vide Notification No. 2/2019-Central tax, dated 29-Jan-2019
Every person supplying online information and database access or retrieval services from a place outside India to a person in India, other than a registered taxable person	
Such other person or class of persons as may be notified by the Central Government or a State Government on the recommendations of the Council	

Casual Taxable Person

Traders (especially Jewellers) registered in one State carry goods to another State and upon receipt of approval from the customers, sell the goods to such customers. The issue that arises for consideration is whether such jewellers are required to register as casual taxable persons in the State of the buyer. In this context, Circular No.10/10/2017-GST, dated 18.10.2017 has been issued to clarify that in the given case, Supplier is not able to ascertain the actual supplies beforehand and ascertainment of tax liability is a mandatory requirement for registration as a casual taxable person and hence, he is not required to get registered as a casual taxable person.

The concept of casual taxable person could get redundant based on the reasoning's provided in the aforementioned Circular. In a case where a trader travels to another State for participation in an exhibition-cum-sale, even he is unable to determine the actual supplies beforehand as a consequence of which he is unable to ascertain his tax liability and accordingly based on the aforementioned Circular, he is not required to obtain a casual taxable person registration. However, experts hold the view that the aforesaid situations are not *pari materia*, hence, in the later situation registration as casual taxable person may be mandatory.

“Sale/ Supply of goods on approval” would mean dispatch of goods to another person with an option to the other person to return or retain within a short period of time. In the above case, the goods are not being handed over to another person for retention/ return within a short period of time. This is a case where supply, if any, is getting confirmed immediately and is not significantly different from over the counter sale where the customer is shown say, ten designs of jewellery and he confirms one from the ten designs.

Alternatively, it would be relevant to note that the goods are being carried for “approval”. This would mean that the supplier carries the goods to “identified customer” who will approve the goods. In case of exhibition, the supplier carries the goods to “unidentified customer” and once the unidentified customer approves the product, the sale is confirmed. In the second case, the supplier becomes a casual taxable person while in the first case, it is an IGST sale.

Agent

Section 24 clause (vii) provides that an agent who makes taxable supply of goods or services on behalf of other person, is compulsorily required to obtain registration independent of the aggregate turnover threshold limit provided under section 22. The term “agent” here refers to the “agent” who supplies goods to the customers under his invoice on behalf of the principal (linked to Para 3 of Schedule I of the CGST Act which refers to deemed supply of goods by principal to agent where the agent undertakes to supply goods on behalf of the principal) and it does not cover within its ambit, all types of agents like those who act as intermediary. This matter has also been clarified in the Circular No. 57/31/2018-GST dated September 4, 2018 and also Circular No. 73/47/2018-GST, dated November 5, 2018.

Issues / Concerns:

- a. Section 23 v. Section 24: Section 24 overrides sections 22(1) and accordingly persons enumerated under sections 24 are required to obtain compulsory registration irrespective of whether their turnover exceeds the threshold limit specified under sections 22(1). However, sections 24 does not specifically override sections 23. In case there is a conflict between sections 23 and sections 24, the issue is which provision will prevail. Consider a scenario where a hospital is providing health care services which are exempt from GST. The turnover of the hospital is ₹ 10 Crores. The hospital has imported certain services from outside India worth ₹ 5 Lakhs. The impact of sections 22, 23 and 24 are provided below:

Provision	Impact
Section 22	Not Liable to register since they are NOT providing any taxable supply and it is a pre requisite u/s. 22(1) to take registration in that State from where a person makes TAXABLE SUPPLY of goods or services, provided aggregate turnover exceeds ₹ 20/10 lakhs.
Section 23	Not required to register since they deal exclusively in exempt supplies
Section 24	Mandates registration since liable to pay tax under reverse charge on import of services.

Further, since section 24 only overrides section 22(1) and not section 23, a logical view enumerates that registration is not required in the above case. However, in the absence of any clarification on the issue by the department, there are possibilities of department litigating the matter but the same needs to be defended based on merits.

In this context, it would be interesting to note that section 23(2) of the CGST Act empowers the Government to issue notification exempting category of persons from obtaining registration. The Central Government has issued various notifications under the said provision to exempt persons who were otherwise required to register based on section 24.

Statutory Provisions- Effective from 1st July 2017 to 31st January 2019

25. Procedure for registration

- (1) *Every person who is liable to be registered under section 22 or section 24 shall apply for registration in every such State or Union territory in which he is so liable within thirty days from the date on which he becomes liable to registration, in such manner and subject to such conditions as may be prescribed:*

Provided that a casual taxable person or a non-resident taxable person shall apply for registration at least five days prior to the commencement of business.

Explanation. - Every person who makes a supply from the territorial waters of India shall obtain registration in the coastal State or Union territory where the nearest point of the appropriate baseline is located.

- (2) *A person seeking registration under this Act shall be granted a single registration in a State or Union territory:*

Provided that a person having multiple business verticals in a State or Union territory may be granted a separate registration for each business vertical, subject to such conditions as may be prescribed.

- (3) *A person, though not liable to be registered under section 22 or section 24 may get himself registered voluntarily, and all provisions of this Act, as are applicable to a registered person, shall apply to such person.*

- (4) *A person who has obtained or is required to obtain more than one registration, whether in one State or Union territory or more than one State or Union territory shall, in respect of each such registration, be treated as distinct persons for the purposes of this Act.*

- (5) *Where a person who has obtained, or is required to obtain registration in a State or Union territory in respect of an establishment, has an establishment in another State or Union territory, then such establishments shall be treated as establishments of distinct persons for the purposes of this Act.*

- (6) *Every person shall have a Permanent Account Number issued under the Income Tax Act, 1961 (43 of 1961) in order to be eligible for grant of registration:*

Provided that a person required to deduct tax under section 51 may have, in lieu of a Permanent Account Number, a Tax Deduction and Collection Account Number issued under the said Act in order to be eligible for grant of registration.

- (7) *Notwithstanding anything contained in sub-section (6), a non-resident taxable person may be granted registration under sub-section (1) on the basis of such other documents as may be prescribed.*
- (8) *Where a person who is liable to be registered under this Act fails to obtain registration, the proper officer may, without prejudice to any action which may be taken under this Act or under any other law for the time being in force, proceed to register such person in such manner as may be prescribed.*
- (9) *Notwithstanding anything contained in sub-section (1), —*
- (a) *any specialised agency of the United Nations Organisation or any Multilateral Financial Institution and Organisation notified under the United Nations (Privileges and Immunities) Act, 1947 (46 of 1947), Consulate or Embassy of foreign countries; and*
- (b) *any other person or class of persons, as may be notified by the Commissioner, shall be granted a Unique Identity Number in such manner and for such purposes, including refund of taxes on the notified supplies of goods or services or both received by them, as may be prescribed.*
- (10) *The registration or the Unique Identity Number shall be granted or rejected after due verification in such manner and within such period as may be prescribed.*
- (11) *A certificate of registration shall be issued in such form and with effect from such date as may be prescribed.*
- (12) *A registration or a Unique Identity Number shall be deemed to have been granted after the expiry of the period prescribed under sub-section (10), if no deficiency has been communicated to the applicant within that period.*

Statutory Provisions- Effective from 1st February 2019 vide The Central Goods & Services Tax Amendment Act, 2018

25. Procedure for registration

- (13) *Every person who is liable to be registered under section 22 or section 24 shall apply for registration in every such State or Union territory in which he is so liable within thirty days from the date on which he becomes liable to registration, in such manner and subject to such conditions as may be prescribed:*

Provided that a casual taxable person or a non-resident taxable person shall apply for registration at least five days prior to the commencement of business.

Provided further that a person having a unit, as defined in the Special Economic Zones Act, 2005, in a Special Economic Zone or being a Special Economic Zone developer shall have to apply for a separate registration, as distinct from his place of

business located outside the Special Economic Zone in the same State or Union territory.

Explanation. - Every person who makes a supply from the territorial waters of India shall obtain registration in the coastal State or Union territory where the nearest point of the appropriate baseline is located.

- (14) *A person seeking registration under this Act shall be granted a single registration in a State or Union territory:*

Provided that a person having multiple places of business in a State or Union territory may be granted a separate registration for each such place of business, subject to such conditions as may be prescribed..

- (15) *A person, though not liable to be registered under section 22 or section 24 may get himself registered voluntarily, and all provisions of this Act, as are applicable to a registered person, shall apply to such person.*

- (16) *A person who has obtained or is required to obtain more than one registration, whether in one State or Union territory or more than one State or Union territory shall, in respect of each such registration, be treated as distinct persons for the purposes of this Act.*

- (17) *Where a person who has obtained, or is required to obtain registration in a State or Union territory in respect of an establishment, has an establishment in another State or Union territory, then such establishments shall be treated as establishments of distinct persons for the purposes of this Act.*

- (18) *Every person shall have a Permanent Account Number issued under the Income Tax Act, 1961 (43 of 1961) in order to be eligible for grant of registration:*

Provided that a person required to deduct tax under section 51 may have, in lieu of a Permanent Account Number, a Tax Deduction and Collection Account Number issued under the said Act in order to be eligible for grant of registration.

- (19) *Notwithstanding anything contained in sub-section (6), a non-resident taxable person may be granted registration under sub-section (1) on the basis of such other documents as may be prescribed.*

- (20) *Where a person who is liable to be registered under this Act fails to obtain registration, the proper officer may, without prejudice to any action which may be taken under this Act or under any other law for the time being in force, proceed to register such person in such manner as may be prescribed.*

- (21) *Notwithstanding anything contained in sub-section (1), —*

(a) any specialised agency of the United Nations Organisation or any Multilateral Financial Institution and Organisation notified under the United Nations

(Privileges and Immunities) Act, 1947 (46 of 1947), Consulate or Embassy of foreign countries; and

- (b) any other person or class of persons, as may be notified by the Commissioner, shall be granted a Unique Identity Number in such manner and for such purposes, including refund of taxes on the notified supplies of goods or services or both received by them, as may be prescribed.*
- (22) The registration or the Unique Identity Number shall be granted or rejected after due verification in such manner and within such period as may be prescribed.*
- (23) A certificate of registration shall be issued in such form and with effect from such date as may be prescribed.*
- (24) A registration or a Unique Identity Number shall be deemed to have been granted after the expiry of the period prescribed under sub-section (10), if no deficiency has been communicated to the applicant within that period.*

Extract of the CGST Rules, 2017

8. Application for registration

- (1) Every person, other than a non-resident taxable person, a person required to deduct tax at source under section 51, a person required to collect tax at source under section 52 and a person supplying online information and database access or retrieval services from a place outside India to a non-taxable online recipient referred to in section 14 of the Integrated Goods and Services Tax Act, 2017 (13 of 2017) who is liable to be registered under sub-section (1) of section 25 and every person seeking registration under sub-section (3) of section 25 (hereafter in this Chapter referred to as “the applicant”) shall, before applying for registration, declare his Permanent Account Number, mobile number, e-mail address, State or Union territory in Part A of FORM GST REG-01 on the common portal, either directly or through a Facilitation Centre notified by the Commissioner:*

²Provided ³that every person being an Input Service Distributor shall make a separate application for registration as such Input Service Distributor.

- (2) (a) The Permanent Account Number shall be validated online by the common portal from the database maintained by the Central Board of Direct Taxes.*
- (b) The mobile number declared under sub-rule (1) shall be verified through a one-time password sent to the said mobile number; and*

² Omitted vide Notf no. 03/2019-CT dt. 29.01.2019 wef 01.02.2019

³ Omitted vide Notf no. 03/2019-CT dt. 29.01.2019 wef 01.02.2019

(c) The e-mail address declared under sub-rule (1) shall be verified through a separate one-time password sent to the said e-mail address.

- (3) On successful verification of the Permanent Account Number, mobile number and e-mail address, a temporary reference number shall be generated and communicated to the applicant on the said mobile number and e-mail address.
- (4) Using the reference number generated under sub-rule (3), the applicant shall electronically submit an application in Part B of FORM GST REG-01, duly signed or verified through electronic verification code, along with the documents specified in the said Form at the common portal, either directly or through a Facilitation Centre notified by the Commissioner.
- (5) On receipt of an application under sub-rule (4), an acknowledgement shall be issued electronically to the applicant in FORM GST REG-02.
- (6) A person applying for registration as a casual taxable person shall be given a temporary reference number by the common portal for making advance deposit of tax in accordance with the provisions of section 27 and the acknowledgement under sub-rule (5) shall be issued electronically only after the said deposit.

9. Verification of the application and approval

- (1) The application shall be forwarded to the proper officer who shall examine the application and the accompanying documents and if the same are found to be in order, approve the grant of registration to the applicant within a period of three working days from the date of submission of the application.
- (2) Where the application submitted under rule 8 is found to be deficient, either in terms of any information or any document required to be furnished under the said rule, or where the proper officer requires any clarification with regard to any information provided in the application or documents furnished therewith, he may issue a notice to the applicant electronically in FORM GST REG-03 within a period of three working days from the date of submission of the application and the applicant shall furnish such clarification, information or documents electronically, in FORM GST REG-04, within a period of seven working days from the date of the receipt of such notice.

Explanation.- For the purposes of this sub-rule, the expression “clarification” includes modification or correction of particulars declared in the application for registration, other than Permanent Account Number, State, mobile number and e-mail address declared in Part A of FORM GST REG-01.

- (3) Where the proper officer is satisfied with the clarification, information or documents furnished by the applicant, he may approve the grant of registration to the applicant within a period of seven working days from the date of the receipt of such clarification or information or documents.
- (4) Where no reply is furnished by the applicant in response to the notice issued under sub-rule (2) or where the proper officer is not satisfied with the clarification,

information or documents furnished, he shall, for reasons to be recorded in writing, reject such application and inform the applicant electronically in FORM GST REG-05.

- (5) If the proper officer fails to take any action, -
- (a) within a period of three working days from the date of submission of the application; or
 - (b) within a period of seven working days from the date of the receipt of the clarification, information or documents furnished by the applicant under sub-rule (2),
- the application for grant of registration shall be deemed to have been approved.

10. Issue of registration certificate

- (1) Subject to the provisions of sub-section (12) of section 25, where the application for grant of registration has been approved under rule 9, a certificate of registration in FORM GST REG-06 showing the principal place of business and additional place or places of business shall be made available to the applicant on the common portal and a Goods and Services Tax Identification Number shall be assigned subject to the following characters, namely:-
- (a) two characters for the State code;
 - (b) ten characters for the Permanent Account Number or the Tax Deduction and Collection Account Number;
 - (c) two characters for the entity code; and
 - (d) one checksum character.
- (2) The registration shall be effective from the date on which the person becomes liable to registration where the application for registration has been submitted within a period of thirty days from such date.
- (3) Where an application for registration has been submitted by the applicant after the expiry of thirty days from the date of his becoming liable to registration, the effective date of registration shall be the date of the grant of registration under sub-rule (1) or sub-rule (3) or sub-rule (5) of rule 9.
- (4) Every certificate of registration shall be duly signed or verified through electronic verification code by the proper officer under the Act.
- (5) Where the registration has been granted under sub-rule (5) of rule 9, the applicant shall be communicated the registration number, and the certificate of registration under sub-rule (1), duly signed or verified through electronic verification code, shall be made available to him on the common portal, within a period of three days after the expiry of the period specified in sub-rule (5) of rule 9.

11. Separate registration for multiple places of business within a State or a Union territory

(1) Any person having multiple places of business within a State or a Union territory, requiring a separate registration for any such place of business under sub-section (2) of section 25 shall be granted separate registration in respect of each such place of business subject to the following conditions, namely: —

- (a) such person has more than one place of business as defined in clause (85) of section 2;
- (b) such person shall not pay tax under section 10 for any of his places of business if he is paying tax under section 9 for any other place of business;
- (c) all separately registered places of business of such person shall pay tax under the Act on supply of goods or services or both made to another registered place of business of such person and issue a tax invoice or a bill of supply, as the case may be, for such supply.

Explanation. —For the purposes of clause (b), it is hereby clarified that where any place of business of a registered person that has been granted a separate registration becomes ineligible to pay tax under section 10, all other registered places of business of the said person shall become ineligible to pay tax under the said section.

- (2) A registered person opting to obtain separate registration for a place of business shall submit a separate application in FORM GST REG-01 in respect of such place of business.
- (3) The provisions of rule 9 and rule 10 relating to the verification and the grant of registration shall, *mutatis mutandis*, apply to an application submitted under this rule.⁴

12. Grant of registration to persons required to deduct tax at source or to collect tax at source

(1) Any person required to deduct tax in accordance with the provisions of section 51 or a person required to collect tax at source in accordance with the provisions of section 52 shall electronically submit an application, duly signed or verified through electronic verification code, in FORM GST REG-07 for the grant of registration through the common portal, either directly or through a Facilitation Centre notified by the Commissioner.

(1A) A person applying for registration to collect tax in accordance with the provisions of section 52, in a State or Union territory where he does not have a physical presence, shall mention the name of the State or Union territory in PART A

⁴ Substituted vide Notf no. 03/2019-CT dt. 29.01.2019 wef 01.02.2019

of the application in FORM GST REG-07 and mention the name of the State or Union territory in PART B thereof in which the principal place of business is located which may be different from the State or Union territory mentioned in PART A.

- (2) The proper officer may grant registration after due verification and issue a certificate of registration in FORM GST REG-06 within a period of three working days from the date of submission of the application.
- (3) Where, upon an enquiry or pursuant to any other proceeding under the Act, the proper officer is satisfied that a person to whom a certificate of registration in FORM GST REG-06 has been issued is no longer liable to deduct tax at source under section 51 or collect tax at source under section 52, the said officer may cancel the registration issued under sub-rule (2) and such cancellation shall be communicated to the said person electronically in FORM GST REG-08:

Provided that the proper officer shall follow the procedure as provided in rule 22 for the cancellation of registration.

13. Grant of registration to non-resident taxable person

- (1) A non-resident taxable person shall electronically submit an application, along with a self-attested copy of his valid passport, for registration, duly signed or verified through electronic verification code, in FORM GST REG-09, at least five days prior to the commencement of business at the common portal either directly or through a Facilitation Centre notified by the Commissioner:

Provided that in the case of a business entity incorporated or established outside India, the application for registration shall be submitted along with its tax identification number or unique number on the basis of which the entity is identified by the Government of that country or its Permanent Account Number, if available.

- (2) A person applying for registration as a non-resident taxable person shall be given a temporary reference number by the common portal for making an advance deposit of tax in accordance with the provisions of section 27 and the acknowledgement under sub-rule (5) of rule 8 shall be issued electronically only after the said deposit in his electronic cash ledger.
- (3) The provisions of rule 9 and rule 10 relating to the verification and the grant of registration shall, *mutatis mutandis*, apply to an application submitted under this rule.
- (4) The application for registration made by a non-resident taxable person shall be duly signed or verified through electronic verification code by his authorised signatory who shall be a person resident in India having a valid Permanent Account Number.

14. Grant of registration to a person supplying online information and database access or retrieval services from a place outside India to a non-taxable online recipient

- (1) Any person supplying online information and database access or retrieval services

from a place outside India to a non-taxable online recipient shall electronically submit an application for registration, duly signed or verified through electronic verification code, in FORM GST REG-10, at the common portal, either directly or through a Facilitation Centre notified by the Commissioner.

- (2) *The applicant referred to in sub-rule (1) shall be granted registration, in FORM GST REG-06, subject to such conditions and restrictions and by such officer as may be notified by the Central Government on the recommendations of the Council.*

15. Extension in period of operation by casual taxable person and non-resident taxable person

- (1) *Where a registered casual taxable person or a non-resident taxable person intends to extend the period of registration indicated in his application of registration, an application in FORM GST REG-11 shall be submitted electronically through the common portal, either directly or through a Facilitation Centre notified by the Commissioner, by such person before the end of the validity of registration granted to him.*
- (2) *The application under sub-rule (1) shall be acknowledged only on payment of the amount specified in sub-section (2) of section 27*

16. Suo moto registration

- (1) *Where, pursuant to any survey, enquiry, inspection, search or any other proceedings under the Act, the proper officer finds that a person liable to registration under the Act has failed to apply for such registration, such officer may register the said person on a temporary basis and issue an order in FORM GST REG-12.*
- (2) *The registration granted under sub-rule (1) shall be effective from the date of such order granting registration.*
- (3) *Every person to whom a temporary registration has been granted under sub-rule (1) shall, within a period of ninety days from the date of the grant of such registration, submit an application for registration in the form and manner provided in rule 8 or rule 12:*
- Provided that where the said person has filed an appeal against the grant of temporary registration, in such case, the application for registration shall be submitted within a period of thirty days from the date of the issuance of the order upholding the liability to registration by the Appellate Authority.*
- (4) *The provisions of rule 9 and rule 10 relating to verification and the issue of the certificate of registration shall, mutatis mutandis, apply to an application submitted under sub-rule (3).*
- (5) *The Goods and Services Tax Identification Number assigned, pursuant to the verification under sub-rule (4), shall be effective from the date of the order granting registration under sub-rule (1).*

17. Assignment of Unique Identity Number to certain special entities

- (1) Every person required to be granted a Unique Identity Number in accordance with the provisions of sub-section (9) of section 25 may submit an application electronically in FORM GST REG-13, duly signed or verified through electronic verification code, in the manner specified in rule 8 at the common portal, either directly or through a Facilitation Centre notified by the Commissioner.
- (1A) The Unique Identity Number granted under sub-rule (1) to a person under clause (a) of sub-section (9) of section 25 shall be applicable to the territory of India.
- (2) The proper officer may, upon submission of an application in FORM GST REG-13 or after filling up the said form or after receiving a recommendation from the Ministry of External Affairs, Government of India, assign a Unique Identity Number to the said person and issue a certificate in FORM GST REG-06 within a period of three working days from the date of the submission of the application.

25. Physical verification of business premises in certain cases. -

Where the proper officer is satisfied that the physical verification of the place of business of a registered person is required after the grant of registration, he may get such verification done and the verification report along with the other documents, including photographs, shall be uploaded in **FORM GST REG-30** on the common portal within a period of fifteen working days following the date of such verification.

Relevant circulars, notifications, clarifications, flyers issued by Government:

- Chapter one of the compilation of the GST Flyers titled 'Registration under GST Law', as issued by the CBIC (erstwhile CBEC).
- Notification No. 2/2019-Central Tax, dated 29-Jan-2019, seeks to bring in force the Central Goods and Services Tax (Amendment) Act, 2018, w.e.f. 1-Feb-2019.
- Notification No. 3/2019-Central Tax, dated 29-Jan-2019, substituted rule 11 of CGST Rules, 2017 w.e.f. 1-Feb-2019.
- Notification No. 74/2018-Central Tax, dated 31-Dec-2018 inserted sub-rule (1A) to rule 12 for e-commerce operator applying for registration where it does not have physical presence.

Related provisions of the Statute

Section or Rule	Description
Section 22	Persons liable for registration
Section 24	Compulsory registration in certain cases
Section 51	Tax deduction at source
Section 52	Collection of tax at source

25.1 Analysis

Every registered person is considered a 'distinct person' for the limited purposes of GST. This is a very important fiction supplied by law so as to overcome the deficiency to constitute a 'supply' within branches of the same entity or person. But for this fiction, imputing 'supply' in respect of supply-like transactions between branches of the same entity or person would have been impossible, in spite of Schedule I. In fact, the fiction of 'distinct persons' flows into Schedule I and supports the levy of tax on branch-transfers. While branch transfer involving goods is understandable, branch transfers involving services too are taxable, but that is discussed under supply which may be referred.

Section 25 read with rules 8 to 26 of the CGST Rules related to registration provides a detailed road map on the procedural aspects of the registration. The time limit for application is within 30 days (for persons other than casual taxable person or a non-resident taxable person) and casual taxable person or a non-resident taxable person shall have to obtain the registration at least 5 days prior to the commencement.

Single registration will be granted from one State or Union Territory and in case of persons having business across different States, then multiple registrations are granted. Now, as per CGST (Amendment) Act, 2018 with effect from 1-Feb-2019, even in a single State, multiple registrations are possible wherever a person has multiple places of business in the same one State.

Implications of CGST (Amendment) Act, 2018

1. Concept of business vertical has been removed from GST (Business vertical meant different lines of businesses which carry different risk and reward);

Taxpayers can now opt for separate registrations in a State based on location for each of the business (though they are in similar line of business)

Illustration

Situation	Pre-Amendment	Post-Amendment
Business 1 – IT Software Services Business 2 – Employee Training Services Location – Common Office	Separate registration possible since the tax payer has separate business vertical	Separate registration not possible since the businesses are operating from a common location
Business 1 – Hotel Business 2 – Hotel Location – Separate Locations	Separate registration not possible since the tax payer has single business vertical	Separate registration possible since businesses are located at different locations

Further, as per second proviso to section 25, a Special Economic Zone unit or Special Economic Zone developer shall make a separate application for registration as distinct place

of business from its other units located outside the Special Economic Zone. Rule 8 provides detailed procedure for application of registration by a person desirous of seeking registration under GST.

Every person being an Input Service Distributor shall make a separate application for registration as such Input Service Distributor.

Where a person who is liable to be registered under this Act fails to obtain registration, the proper officer can proceed to register such person in the manner as may be prescribed.

The registration shall be effective from the date on which the person becomes liable to registration where the application for registration has been submitted within a period of thirty days from such date. Where an application for registration has been submitted by the applicant after the expiry of thirty days from the date of his becoming liable to registration, the effective date of registration shall be the date of the grant of registration.

Registration Certificate is issued in **FORM GST REG-06**.

The registration rules prescribe 30 different forms in respect of registration matters. The application for registration should be disposed off in a time bound manner and detailed time limits have been prescribed under the rules for various purposes.

Sl. No	Form No.	Title of the Form
1	GSTREG-01	Application for registration
2	GSTREG-02	Acknowledgement
3	GSTREG-03	Notice for seeking additional information/ clarification/ documents relating to application for registration/ amendment/ cancellation
4	GSTREG-04	Clarification/ additional information/ document for registration/ amendment/ cancellation
5	GSTREG-05	Order of rejection of application for registration/ amendment/ cancellation
6	GSTREG-06	Registration Certificate
7	GSTREG-07	Application for Registration as Tax Deductor at source u/s 51 or Tax Collector at source u/s 52
8	GSTREG-08	Order of cancellation of registration as Tax deductor at source or Tax collector at source
9	GSTREG-09	Application for Registration of Non-Resident Taxable Person
10	GSTREG-10	Application for registration of person supplying online information and data base access or retrieval services from a

		place outside India to a person in India, other than a registered person
11	GSTREG-11	Application for extension of registration period by causal taxable person or non-resident taxable person
12	GSTREG-12	Order of Grant of Temporary registration/ <i>Suo Moto</i> Registration
13	GSTREG-13	Application/ Form for grant of Unique Identity Number (UIN) to UN Bodies/ Embassies/ others
14	GSTREG-14	Application for Amendment in Registration Particulars (For all types of registered persons)
15	GSTREG-15	Order of Amendment
16	GSTREG-16	Application for Cancellation of Registration
17	GSTREG-17	Show Cause Notice for Cancellation of Registration
18	GSTREG-18	Reply to the Show Cause Notice issued for cancellation for registration
19	GSTREG-19	Order for Cancellation of Registration
20	GSTREG-20	Order for dropping the proceedings for cancellation of registration
21	GSTREG-21	Application for Revocation of Cancellation of Registration
22	GSTREG-22	Order for revocation of cancellation of registration
23	GSTREG-23	Show Cause Notice for rejection of application for revocation of cancellation of registration
24	GSTREG-24	Reply to the notice for rejection of application for revocation of cancellation of registration
25	GSTREG-25	Certificate of Provisional Registration
26	GSTREG-26	Application for Enrolment of Existing Taxpayer
27	GSTREG-27	Show Cause Notice for cancellation of provisional registration
28	GSTREG-28	Order for cancellation of provisional registration
29	GSTREG-29	Application for cancellation of registration of migrated taxpayers
30	GSTREG-30	Form for Field Visit Report

Requirement of a Permanent Account Number or Tax Deduction and Collection Account Number

Every person who is liable to obtain registration or wants to obtain voluntary registration is required to have a Permanent Account Number (PAN).

Every person required to deduct tax under section 51 may have, in lieu of a Permanent Account Number, a Tax Deduction and Collection Account Number (TAN)

A non-resident taxable person can obtain registration on the basis of any other document as may be prescribed.

Registration for United Nations or Consulate or Embassy:

Any specialized agency of the United Nations Organization or any Multilateral Financial Institution and Organization notified under the United Nations (Privileges and Immunities) Act, 1947 (46 of 1947), Consulate or Embassy of foreign countries and any other person or class of persons as may be notified by the Commissioner, shall obtain a Unique Identity Number. The registration shall be for the purpose(s) notified, including seeking to claim refund of taxes paid by them, on the notified supplies of goods and/or services received by them. The supplier supplying to these organization is expected to mention the UID on the invoices and treat such supplies as business to business (B2B) supplies.

Grant of Registration by Proper Officer

The registration or Unique Identity Number, (UID) is granted/ issued with effective dates. The registration or UID is granted or rejected after due verification. A certificate of registration shall also be issued in prescribed form with effective date as may be prescribed. The Unique Identity Number granted to any person shall be applicable to the territory of whole India. (Reference Notification No. 75/2017 - Central Tax, Dated 29th December 2017)

A registration or a UID shall be deemed to have been granted after the period prescribed under sub-section (10) of section 25 of the Act] if no deficiency has been communicated to the applicant within that period. Also, the grant of registration or the Unique Identity Number under the CGST Act/ SGST Act shall be deemed to be a grant of registration or the Unique Identity Number under the SGST/CGST Act provided that the application for registration or the UID has not been rejected/no deficiency has been communicated to applicant by the proper officer under SGST/CGST Act within the time specified. As per rule 17 of CGST Rules the proper officer may upon submission of FORM GST REG-13 assign UID to these persons and issue a certificate in FORM GST REG-06 within a period of 3 working days from the date of submission of application.

Physical Verification of place of business:

Where the proper officer is satisfied that the physical verification of the place of business of a registered person is required after the grant of registration, he may get such verification done. The verification report along with the other documents, including photographs, shall be uploaded in FORM GST REG-30 on the common portal within a period of 15 working days following the date of such verification.

Issues/ Concerns:

- (a) Relaxation of time-limit for effective date of registration: There are numerous ground level issues faced by the tax payers w.r.t. IT infrastructure glitches, plethora of notifications/ circulars, corrigendum, amendments, interpretation of laws etc. on account of which the industry has been grappling with various issues including registration procedures. In this background, in cases where the application for registration has been belatedly made, it would be unfair to the tax payer if the effective date of registration is not considered from the date of liability itself.

Statutory Provisions**26. Deemed registration**

- (1) *The grant of registration or the Unique Identity Number under the State Goods and Services Tax Act or the Union Territory Goods and Services Tax Act shall be deemed to be a grant of registration or the Unique Identity Number under this Act subject to the condition that the application for registration or the Unique Identity Number has not been rejected under this Act within the time specified in sub-section (10) of section 25.*
- (2) *Notwithstanding anything contained in sub-section (10) of section 25, any rejection of application for registration or the Unique Identity Number under the State Goods and Services Tax Act or the Union Territory Goods and Services Tax Act shall be deemed to be a rejection of application for registration under this Act.*

Relevant circulars, notifications, clarifications, flyers issued by Government: -

1. Chapter one of the compilations of the GST Flyers titled 'Registration under GST Law', as issued by the CBIC (erstwhile CBEC).

Related provisions of the Statute:

Section or Rule	Description
Section 22	Persons liable for registration
Section 25	Procedure for registration

26.1 Analysis

These are the linking provisions between the Central Goods and Services Tax and State/Union Territory Goods and Services Tax Act. By enabling these provisions, the burden of taking registrations under various Acts has been removed. Thus, if a supplier takes a registration under one Act it shall be deemed that the registration has also been obtained under the other Act and *vice-versa*. Even otherwise the registration must be taken on the

common portal and is based on the PAN hence the registration will remain common across various Acts.

However, if the registration is rejected under the Central Goods and Services Tax Act, then such rejection will be treated as if the registration has not been obtained under the Central Goods and Services Tax Act even though it has been obtained in State/Union Territory Goods and Services Tax Act.

If an application for registration has been rejected under State/Union Territory Goods and Services Tax Act then it shall be deemed that the same has been rejected under the Central Goods and Services Tax Act.

Rejection of Application for Registration:

The proper officer shall not reject the application for registration or the Unique Identification Number (UID) without giving a notice to show cause and without giving the person a reasonable opportunity of being heard.

This implies that the decision to reject an application under this section shall be only after following the principles of natural justice and after a due process of law by issuance of an order. It should also be noted that any rejection of application for registration or the Unique Identity Number under the CGST Act/ SGST Act shall be deemed to be a rejection of application for registration under the SGST Act/ CGST Act respectively as the case may be.

Statutory Provisions

27. Special provisions relating to casual taxable person and Non-resident taxable person

- (1) *The certificate of registration issued to a casual taxable person or a non-resident taxable person shall be valid for a period specified in the application for registration or ninety days from the effective date of registration, whichever is earlier and such person shall make taxable supplies only after the issuance of the certificate of registration:*

Provided that the proper officer may, on sufficient cause being shown by the said taxable person, extend the said period of ninety days by a further period not exceeding ninety days.

- (2) *A casual taxable person or a non-resident taxable person shall, at the time of submission of application for registration under sub-section (1) of section 25, make an advance deposit of tax in an amount equivalent to the estimated tax liability of such person for the period for which the registration is sought:*

Provided that where any extension of time is sought under sub-section (1), such taxable person shall deposit an additional amount of tax equivalent to the estimated tax liability of such person for the period for which the extension is sought.

- (3) *The amount deposited under sub-section (2) shall be credited to the electronic cash ledger of such person and shall be utilized in the manner provided under section 49.*

Extract of the CGST Rules, 2017**15. Extension in period of operation by casual taxable person and non-resident taxable person**

- (1) *Where a registered casual taxable person or a non-resident taxable person intends to extend the period of registration indicated in his application of registration, an application in FORM GST REG-11 shall be submitted electronically through the common portal, either directly or through a Facilitation Centre notified by the Commissioner, by such person before the end of the validity of registration granted to him.*
- (2) *The application under sub-rule (1) shall be acknowledged only on payment of the amount specified in sub-section (2) of section 27.*

Relevant circulars, notifications, clarifications, flyers issued by Government: -

1. Chapter one of the compilations of the GST Flyers titled 'Registration under GST Law', as issued by the CBIC (erstwhile CBEC).
2. Circular No. 71/45/2018-GST, dated 26thOctober, 2018, clarifying issues under GST related to casual taxable person

Related provisions of the Statute:

Section or Rule	Description
Section 2(20)	Definition of "casual taxable person"
Section 2(77)	Definition of "non-resident taxable person"
Section 22	Persons liable for registration
Section 24	Compulsory registration in certain cases
Section 25	Procedure for registration

27.1 Analysis

The certificate of registration issued to a "casual taxable person" or a "non-resident taxable person" shall be valid for a period specified in the application for registration or ninety days from the effective date of registration, whichever is earlier, extendable by proper officer for further period of maximum 90 days at the request of taxable person.

A casual taxable person or a non-resident taxable person, while seeking registration, shall make an advance deposit of tax in an amount equivalent to the estimated tax liability. Where any extension of time is sought, such taxable person shall deposit an additional amount of tax equal to the estimated tax liability for the period for which the extension is sought.

Such deposit shall be credited to the electronic cash ledger of casual taxable person or non-resident taxable person and utilized in the manner provided under section 49 (Payment of tax, interest, penalty and other amounts) of the Act.

Since the nature of the activity carried out by a casual taxable person and non-resident taxable person are temporary as compared to a regular taxable person, additional safeguards have been placed to ensure that the registration is granted for a limited period and the tax liability is recovered in advance.

Rule 13 of the CGST Rules, 2017, provides for the detailed process of grant of registration to non-resident taxable person and rule 15 provides for the process of extension in period of operation by casual taxable person and non-resident taxable person.

A non-resident taxable person shall electronically submit an application, along with a self-attested copy of his valid passport, for registration, duly signed or verified through electronic verification code, in FORM GST REG-09, at least five days prior to the commencement of business. In the case of business entity incorporated or established outside India, the application for registration shall be submitted along with its tax identification number or unique number on the basis of which the entity is identified by the Government of that country or its Permanent Account Number.

A person applying for registration as a non-resident taxable person shall be given a temporary reference number by the common portal for making an advance deposit of tax in accordance with the provisions of section 27 and the acknowledgement under sub-rule 5 of rule 8 shall be issued electronically only after the said deposit in his electronic cash ledger.

Rule 9 and rule 10 of the CGST Rules, 2017 shall also apply to an application submitted under this rule. The application for registration made by a non-resident taxable person shall be duly signed or verified through electronic verification code by his authorized signatory who shall be a person resident in India having a valid Permanent Account Number.

Where a registered casual taxable person or a non-resident taxable person intends to extend the period of registration indicated in his application of registration, an application in FORM GST REG-11 shall be submitted electronically, by such person before the end of the validity of registration granted to him. Such application shall be acknowledged only on payment of the amount specified in sub-section (2) of section 27.

Circular No. 71/45/2018-GST dated October 26, 2018, clarified that in case of long running exhibitions (for a period more than 180 days), the taxable person cannot be treated as a casual taxable person and thus, such person would be required to obtain registration as a normal taxable person. In such cases he would not be required to pay advance tax for the purpose of registration.

Deposit of tax

There was lack of clarity on whether the term 'tax liability' refers to output tax liability before adjustment of input tax or after adjustment of input tax. Having to make an advance deposit of tax on the output tax liability (without adjustment of input tax) would be unfair to the taxpayers and cause undue financial hardships. In this regard, Circular No. 71/45/2018-GST dated October 26, 2018 has been issued to clarify that tax to be deposited by the casual taxable

person will be “estimated net tax liability” after considering ITC available to such taxable person.

Statutory Provisions

28. Amendment of Registration

- (1) *Every registered person and a person to whom a Unique Identity Number has been assigned shall inform the proper officer of any changes in the information furnished at the time of registration or subsequent thereto, in such form and manner and within such period as may be prescribed.*
- (2) *The proper officer may, on the basis of information furnished under sub-section (1) or as ascertained by him, approve or reject amendments in the registration particulars in such manner and within such period as may be prescribed:*
Provided that approval of the proper officer shall not be required in respect of amendment of such particulars as may be prescribed:
Provided further that the proper officer shall not reject the application for amendment in the registration particulars without giving the person an opportunity of being heard.
- (3) *Any rejection or approval of amendments under the State Goods and Services Tax Act or the Union Territory Goods and Services Tax Act, as the case may be, shall be deemed to be a rejection or approval under this Act.*

Extract of the CGST Rules, 2017

19. Amendment of registration

- (1) *Where there is any change in any of the particulars furnished in the application for registration in FORM GST REG-01 or FORM GST REG-07 or FORM GST REG-09 or FORM GST REG-10 or for Unique Identity Number in FORM GSTREG-13, either at the time of obtaining registration or Unique Identity Number or as amended from time to time, the registered person shall, within a period of fifteen days of such change, submit an application, duly signed or verified through electronic verification code, electronically in FORM GST REG-14, along with the documents relating to such change at the common portal, either directly or through a Facilitation Centre notified by the Commissioner:*
Provided that – (a) where the change relates to,-
 - (i) *legal name of business;*
 - (ii) *address of the principal place of business or any additional place(s) of business; or*
 - (iii) *addition, deletion or retirement of partners or directors, Karta, Managing Committee, Board of Trustees, Chief Executive Officer or equivalent, responsible for the day to day affairs of the business,-*

which does not warrant cancellation of registration under section 29, the proper officer shall, after due verification, approve the amendment within a period of fifteen working days from the date of the receipt of the application in FORM GST REG-14 and issue an order in FORM GST REG-15 electronically and such amendment shall take effect from the date of the occurrence of the event warranting such amendment;

- (b) the change relating to sub-clause (i) and sub-clause (iii) of clause (a) in any State or Union territory shall be applicable for all registrations of the registered person obtained under the provisions of this Chapter on the same Permanent Account Number;*
- (c) where the change relates to any particulars other than those specified in clause (a), the certificate of registration shall stand amended upon submission of the application in FORM GST REG-14 on the common portal;*
- (d) where a change in the constitution of any business results in the change of the Permanent Account Number of a registered person, the said person shall apply for fresh registration in FORM GST REG-01:*

Provided further that any change in the mobile number or e-mail address of the authorised signatory submitted under this rule, as amended from time to time, shall be carried out only after online verification through the common portal in the manner provided under sub-rule (2) of rule 8.

- (1A) Notwithstanding anything contained in sub-rule (1), any particular of the application for registration shall not stand amended with effect from a date earlier than the date of submission of the application in FORM GST REG-14 on the common portal except with the order of the Commissioner for reasons to be recorded in writing and subject to such conditions as the Commissioner may, in the said order, specify.*
- (2) Where the proper officer is of the opinion that the amendment sought under sub-rule (1) is either not warranted or the documents furnished therewith are incomplete or incorrect, he may, within a period of fifteen working days from the date of the receipt of the application in FORM GST REG-14, serve a notice in FORM GST REG-03, requiring the registered person to show cause, within a period of seven working days of the service of the said notice, as to why the application submitted under sub-rule (1) shall not be rejected.*
- (3) The registered person shall furnish a reply to the notice to show cause, issued under sub-rule (2), in FORM GST REG-04, within a period of seven working days from the date of the service of the said notice.*
- (4) Where the reply furnished under sub-rule (3) is found to be not satisfactory or where no reply is furnished in response to the notice issued under sub-rule (2) within the period prescribed in sub-rule (3), the proper officer shall reject the application submitted under sub-rule (1) and pass an order in FORM GST REG-05.*

<p>(5) <i>If the proper officer fails to take any action,-</i></p> <p>(a) <i>within a period of fifteen working days from the date of submission of the application, or</i></p> <p>(b) <i>within a period of seven working days from the date of the receipt of the reply to the notice to show cause under sub-rule (3),</i></p> <p><i>the certificate of registration shall stand amended to the extent applied for and the amended certificate shall be made available to the registered person on the common portal.</i></p>
--

Relevant circulars, notifications, clarifications, flyers issued by Government: -

- Chapter one of the compilations of the GST Flyers titled 'Registration under GST Law', as issued by the CBIC (erstwhile CBEC).

Related provisions of the Statute

Section or Rule	Description
Section 22	Persons liable for registration
Section 25	Procedure for registration

28.1 Analysis

There are various situations in which the Registration Certificate issued by the competent authority requires amendment in line with real time situations. Under these circumstances, every registered taxable person shall inform any changes in the information furnished at the time of registration.

The proper officer shall not reject the request for amendment without affording a reasonable opportunity of being heard by following the principles of natural justice. Any rejection or approval of amendments under the State Goods and Services Tax Act or Union Territory Goods and Services Act shall be deemed to be a rejection or approval of amendments under the Central Goods and Services Tax Act.

Rule 19 of the CGST Rules, 2017 provide for the detailed process of amendment of registration under GST.

Important Points

- Any change in registration particulars has to be informed **within 15 days of change**
- Proper officer may approve/ reject amendment
- No rejection without giving an opportunity of being heard
- Rejection of amendment under CGST will be a deemed rejection under SGST and *vice-versa*

As per Notification No. 75/2017-Central Tax, Dated 29th December, 2017, it may be noted that amendment in Registration Certificate (in FORM GST REG-14) will stand amended only from the date of application for amendment and not earlier than the date of submission of application except with the order of Commissioner.

Statutory Provisions- Effective from 1st July 2017 to 31st January 2019

29. Cancellation of registration

- (1) *The proper officer may, either on his own motion or on an application filed by the registered person or by his legal heirs, in case of death of such person, cancel the registration, in such manner and within such period as may be prescribed, having regard to the circumstances where, —*
- (a) *the business has been discontinued, transferred fully for any reason including death of the proprietor, amalgamated with other legal entity, demerged or otherwise disposed of; or*
 - (b) *there is any change in the constitution of the business; or*
 - (c) *the taxable person, other than the person registered under sub-section (3) of section 25, is no longer liable to be registered under section 22 or section 24:*
- (2) *The proper officer may cancel the registration of a person from such date, including any retrospective date, as he may deem fit, where, —*
- (a) *a registered person has contravened such provisions of the Act or the rules made thereunder as may be prescribed; or*
 - (b) *a person paying tax under section 10 has not furnished returns for three consecutive tax periods; or*
 - (c) *any registered person, other than a person specified in clause (b), has not furnished returns for a continuous period of six months; or*
 - (d) *any person who has taken voluntary registration under sub-section (3) of section 25 has not commenced business within six months from the date of registration; or*
 - (e) *registration has been obtained by means of fraud, wilful misstatement or suppression of facts:*
- Provided that the proper officer shall not cancel the registration without giving the person an opportunity of being heard:*
- (3) *The cancellation of registration under this section shall not affect the liability of the person to pay tax and other dues under this Act or to discharge any obligation under this Act or the rules made thereunder- for any period prior to the date of cancellation whether or not such tax and other dues are determined before or after the date of cancellation.*

- (4) *The cancellation of registration under the State Goods and Services Tax Act or the Union Territory Goods and Services Tax Act, as the case may be, shall be deemed to be a cancellation of registration under this Act.*
- (5) *Every registered person whose registration is cancelled shall pay an amount, by way of debit in the electronic credit ledger or electronic cash ledger, equivalent to the credit of input tax in respect of inputs held in stock and inputs contained in semi-finished or finished goods held in stock or capital goods or plant and machinery on the day immediately preceding the date of such cancellation or the output tax payable on such goods, whichever is higher, calculated in such manner as may be prescribed:*
- Provided that in case of capital goods or plant and machinery, the taxable person shall pay an amount equal to the input tax credit taken on the said capital goods or plant and machinery, reduced by such percentage points as may be prescribed or the tax on the transaction value of such capital goods or plant and machinery under section 15, whichever is higher.*
- (6) *The amount payable under sub-section (5) shall be calculated in such manner as may be prescribed.*

Statutory Provisions- Effective from 1st February 2019 vide The Central Goods & Services Tax Amendment Act,2018

29. Cancellation or Suspension ⁵of registration

- (1) *The proper officer may, either on his own motion or on an application filed by the registered person or by his legal heirs, in case of death of such person, cancel the registration, in such manner and within such period as may be prescribed, having regard to the circumstances where, —*
- (a) *the business has been discontinued, transferred fully for any reason including death of the proprietor, amalgamated with other legal entity, demerged or otherwise disposed of; or*
- (b) *there is any change in the constitution of the business; or*
- (c) *the taxable person, other than the person registered under sub-section (3) of section 25, is no longer liable to be registered under section 22 or section 24:*
- Provided that during pendency of the proceedings relating to cancellation of registration filed by the registered person, the registration may be suspended for such period and in such manner as may be prescribed.⁶*

⁵ Inserted vide The Central Goods & Services Tax Amendment Act, 2018

⁶ Inserted vide The Central Goods & Services Tax Amendment Act, 2018

- (2) *The proper officer may cancel the registration of a person from such date, including any retrospective date, as he may deem fit, where, —*
- (a) *a registered person has contravened such provisions of the Act or the rules made thereunder as may be prescribed; or*
 - (b) *a person paying tax under section 10 has not furnished returns for three consecutive tax periods; or*
 - (c) *any registered person, other than a person specified in clause (b), has not furnished returns for a continuous period of six months; or*
 - (d) *any person who has taken voluntary registration under sub-section (3) of section 25 has not commenced business within six months from the date of registration; or*
 - (e) *registration has been obtained by means of fraud, wilful misstatement or suppression of facts:*
- Provided that the proper officer shall not cancel the registration without giving the person an opportunity of being heard:*
- Provided further that during pendency of the proceedings relating to cancellation of registration, the proper officer may suspend the registration for such period and in such manner as may be prescribed.⁷*
- (3) *The cancellation of registration under this section shall not affect the liability of the person to pay tax and other dues under this Act or to discharge any obligation under this Act or the rules made thereunder- for any period prior to the date of cancellation whether or not such tax and other dues are determined before or after the date of cancellation.*
- (4) *The cancellation of registration under the State Goods and Services Tax Act or the Union Territory Goods and Services Tax Act, as the case may be, shall be deemed to be a cancellation of registration under this Act.*
- (5) *Every registered person whose registration is cancelled shall pay an amount, by way of debit in the electronic credit ledger or electronic cash ledger, equivalent to the credit of input tax in respect of inputs held in stock and inputs contained in semi-finished or finished goods held in stock or capital goods or plant and machinery on the day immediately preceding the date of such cancellation or the output tax payable on such goods, whichever is higher, calculated in such manner as may be prescribed:*
- Provided that in case of capital goods or plant and machinery, the taxable person shall pay an amount equal to the input tax credit taken on the said capital goods or plant and machinery, reduced by such percentage points as may be prescribed or the tax on the*

⁷ Inserted vide The Central Goods & Services Tax Amendment Act, 2018

transaction value of such capital goods or plant and machinery under section 15, whichever is higher.

- (6) *The amount payable under sub-section (5) shall be calculated in such manner as may be prescribed.*

Extract of the CGST Rules, 2017

20. Application for cancellation of registration

A registered person, other than a person to whom a registration has been granted under rule 12 or a person to whom a Unique Identity Number has been granted under rule 17, seeking cancellation of his registration under sub-section (1) of section 29 shall electronically submit an application in FORM GST REG-16, including therein the details of inputs held in stock or inputs contained in semi-finished or finished goods held in stock and of capital goods held in stock on the date from which the cancellation of registration is sought, liability thereon, the details of the payment, if any, made against such liability and may furnish, along with the application, relevant documents in support thereof, at the common portal within a period of thirty days of the occurrence of the event warranting the cancellation, either directly or through a Facilitation Centre notified by the Commissioner.

21. Registration to be cancelled in certain cases

The registration granted to a person is liable to be cancelled, if the said person,-

- (a) *does not conduct any business from the declared place of business; or*
- (b) *issues invoice or bill without supply of goods or services in violation of the provisions of this Act, or the rules made thereunder; or*
- (c) *violates the provisions of section 171 of the Act or the rules made thereunder.*

21A. Suspension of registration.

- (1) *Where a registered person has applied for cancellation of registration under rule 20, the registration shall be deemed to be suspended from the date of submission of the application or the date from which the cancellation is sought, whichever is later, pending the completion of proceedings for cancellation of registration under rule 22.*
- (2) *Where the proper officer has reasons to believe that the registration of a person is liable to be cancelled under section 29 or under rule 21, he may, after affording the said person a reasonable opportunity of being heard, suspend the registration of such person with effect from a date to be determined by him, pending the completion of the proceedings for cancellation of registration under rule 22.*
- (3) *A registered person, whose registration has been suspended under sub-rule (1) or sub-rule (2), shall not make any taxable supply during the period of suspension and shall not be required to furnish any return under section 39.*
- (4) *The suspension of registration under sub-rule (1) or sub-rule (2) shall be deemed to be revoked upon completion of the proceedings by the proper officer under rule 22 and*

such revocation shall be effective from the date on which the suspension had come into effect.⁸

22. Cancellation of registration.

- (1) *Where the proper officer has reasons to believe that the registration of a person is liable to be cancelled under section 29, he shall issue a notice to such person in FORM GST REG-17, requiring him to show cause, within a period of seven working days from the date of the service of such notice, as to why his registration shall not be cancelled.*
- (2) *The reply to the show cause notice issued under sub-rule (1) shall be furnished in FORM GST REG-18 within the period specified in the said sub-rule.*
- (3) *Where a person who has submitted an application for cancellation of his registration is no longer liable to be registered or his registration is liable to be cancelled, the proper officer shall issue an order in FORM GST REG-19, within a period of thirty days from the date of application submitted under rule 20 or, as the case may be, the date of the reply to the show cause issued under sub-rule (1), cancel the registration, with effect from a date to be determined by him and notify the taxable person, directing him to pay arrears of any tax, interest or penalty including the amount liable to be paid under sub-section (5) of section 29.*
- (4) *Where the reply furnished under sub-rule (2) is found to be satisfactory, the proper officer shall drop the proceedings and pass an order in FORM GST REG-20:*
Provided that where the person instead of replying to the notice served under sub-rule (1) for contravention of the provisions contained in clause (b) or clause (c) of sub-section (2) of section 29, furnishes all the pending returns and makes full payment of the tax dues along with applicable interest and late fee, the proper officer shall drop the proceedings and pass an order in FORM GST-REG-20.
- (5) *The provisions of sub-rule (3) shall, mutatis mutandis, apply to the legal heirs of a deceased proprietor, as if the application had been submitted by the proprietor himself.*

Relevant circulars, notifications, clarifications, flyers issued by Government:-

1. Chapter Two of the compilation of the GST Flyers titled 'Cancellation of Registration in GST, as issued by the CBIC (erstwhile CBEC).
2. Notification No. 3/ 2018-Central Tax, dated January 23, 2018 omitted proviso to rule 20 which provides that a person who has obtained voluntary registration cannot apply for cancellation before expiry of one year from effective date of registration.
3. Notification No. 21/ 2018-Central Tax, dated April, 18, 2018 inserted FORM GSTR-10 "Final return" to be filed by every person whose registration has been cancelled.

⁸ Inserted vide Notf no. 03/2019-CT dt. 29.01.2019 wef 01.02.2019

4.	Notification 39/ 2018-Central Tax, dated September, 4, 2018 inserted proviso to rule 22(4) to provide that where the person furnishes all the pending returns and makes full payment of tax, interest etc., the proper officer shall drop the proceedings.
5.	Notification No. 2/03/ 2019-Central Tax, dated January, 29-Jan-, 2019, seeks to bring in force Central Goods amending Rule 8, Substitution Rule 11 and Services Tax (Amendment) Act, 2018, w.e.f. 1-Feb-2019
6.	Notification No. 3/2019-Central Tax, dated 29-Jan-2019, inserted rule inserting Rule 21A or prescribing the method of suspension of registration. .
7.	Circular No. 69/43/2018-GST, dated October, 26, 2018 clarified issues related to processing of application for cancellation of registration.

Related provisions of the Statute:

Section or Rule	Description
Section 10	Composition Levy
Section 22	Persons liable for registration
Section 24	Compulsory registration in certain cases
Section 25	Procedure for registration
Rule 44	Manner of reversal of credit under special circumstances

29.1 Analysis

Any registration granted under this Act may be cancelled by the Proper Officer. The various circumstances and the provisions of the law on this subject have been outlined under this section.

A registration granted can be cancelled when –

- the business is discontinued, transferred fully for any reason including death of proprietor, amalgamated with other legal entity, demerged or otherwise disposed of; or
- there is any change in the constitution of the business; or
- the taxable person is no longer liable to be registered under sections 22 or section 24.

This is possible after the person is afforded an opportunity of being heard except no such opportunity need to be provided in case the application is filed by the registered taxable person or his legal heirs, in the case of death of such person, for cancellation of registration when –

- the registered taxable person has contravened such provisions of the Act or the rules made thereunder as may be prescribed; or
- a person paying tax under Composition Scheme has not furnished returns for three consecutive tax periods; or

- any registered person who has not furnished returns for a continuous period of six months; or
- any person who has taken voluntary registration and has not commenced business within six months from the date of registration; or
- where registration has been obtained by means of fraud, wilful misstatement or suppression of facts.

CGST (Amendment) Act, 2018 notified with effect from 1-Feb-2019, provided that during the pendency of the proceedings relating to cancellation of registration filed by the registered person, the registration may be suspended for such period and in such manner as may be prescribed.

As such, cancellation of registration, shall not affect the liability of the taxable person to pay tax and other dues under the Act for any period prior to the date of cancellation whether or not such tax and other dues are determined before or after the date of cancellation. The cancellation of registration under State Goods and Services Tax Act or the Union Territory Goods and Services Tax Act shall be deemed to be a cancellation of registration under the Central Goods and Service Tax Act.

Where the registration is cancelled, the registered taxable person shall pay an amount equivalent to the credit of input tax in respect of inputs held in stock and inputs contained in semi-finished or finished goods held in stock on the day immediately preceding the date of such cancellation or the output tax payable on such goods, whichever is higher. The payment can be made by way of debit in the electronic credit or electronic cash ledger.

In case of capital goods, the taxable person shall pay an amount equal to the input tax credit taken on the said capital goods reduced by the prescribed percentage points or the tax on the transaction value of such capital goods [under sub-section (1) of section 15 (Value of taxable supply) of Act], whichever is higher. The amount payable under these provisions shall be calculated in accordance with rule 44 of CGST Rules. The supplier who intends to cancel his registration will be required to file his Final Return in FORM GSTR-10 so as to complete cancellation of registration effectively. (Reference Notification No. 21/2018-Central Tax, dated 18th April, 2018).

As per ruler 20 of the CGST Rules, 2017, application for cancellation of registration by a registered person other than persons required to deduct TDS/ TCS or person to whom UID is granted needs to be made in FORMORM GST REG-16 along with requisite details. In case of a person whose turnover does not exceed the threshold limit but has obtained registration voluntarily may also cancel registration any time during the year. This provision has been introduced *vide* Notification 3/ 2018–Central Tax, date dt 23 January 2018. Earlier, such person could not apply for cancellation before expiry of one year from the effective date of registration.

Rule 21 of the CGST Rules, 2017, provides for cases of cancellation of registration and includes the following:

- a) does not conduct any business from the declared place of business, or
- b) issues invoice or bill without supply of goods or services in violation of the provisions of Act or Rules made thereunder,,
- c) violates the provisions of section 171 of the Act or the rules made thereunder.

Reasons for Cancellation

- Transfer of business or discontinuation of business
- Change in the constitution of business. (Partnership Firm may be changed to Sole Proprietorship due to death of one of the two partners, leading to change in PAN)
- Persons no longer liable to be registered under sections 22 and 24 (Except when he is voluntarily registered)
- Where registered taxable person has contravened provisions of the Act as may be prescribed
- A composition supplier has not furnished returns for 3 consecutive tax periods/ any other person has not furnished returns for a continuous period of 6 months
- Non-commencement of business within 6 months from date of registration by a person who has registered voluntarily

Where registration has been obtained by means of fraud, willful misstatement or suppression of facts, the registration may be cancelled with retrospective effect.

Rule 21A of the CGST Rules, 2017, provides for suspension of registration in the following manner-

- Where a registered person has applied for cancellation of registration, the registration shall be deemed to be suspended from the date of submission of the application or the date from which the cancellation is sought, whichever is later, pending the completion of proceedings for cancellation of registration under rule 22.
- Where the proper officer has reasons to believe that the registration of a person is liable to be cancelled under, he may, after affording the said person a reasonable opportunity of being heard, suspend the registration of such person with effect from a date to be determined by him, pending the completion of the proceedings for cancellation of registration under rule 22.
- A registered person, whose registration has been suspended, shall not make any taxable supply during the period of suspension and shall not be required to furnish any return under section 39.

- The suspension of registration shall be deemed to be revoked upon completion of the proceedings by the proper officer under rule 22 and such revocation shall be effective from the date on which the suspension had come into effect.

The registration of a tax payer is cancelled only upon passing of the cancellation order by the Jurisdictional Officer. In the interim, tax payer is required to file Nil returns else daily penalties will accrue to him. In order to ensure that the tax payer who have applied for cancellation of registration are not burdened with return filing, amendments have been made to section 29 of the CGST Act to change the status of registration to “suspended”. Once the officer changes the status of the registration to “suspended”, the tax payer would not be required to file the GST returns till the order for cancellation has been passed and once the order for cancellation is passed, the tax payer can file the final return and complete the de-registration formalities.

Rule 22 of the CGST Rules, 2017, provides for process of cancellation of registration and includes the following:

- Cancellation can be done by Proper Officer *suomoto* or on application made by the registered person;
- Retrospective cancellation in case of fraud, wilful misstatement or suppression of fact;
- Liability to pay tax before the date of cancellation will not be affected;
- Cancellation under CGST Act will be deemed cancellation under SGST Act and *vice-versa*;
- Substantial penalty in case registration obtained with fraudulent intentions;
- Notice of hearing and opportunity of being heard is a must before cancellation.

Further, Government has issued Circular No. 69/43/2018-GST, dated October 26, 2018 amended vide Circular No. 88/07/2019-GST, dated 1-Feb-2019 on standard operating procedure for processing of applications for cancellation of registration submitted in FORM GST REG-16.

Final Return u/s. 45: As per section 45, “every registered person who is required to furnish a return under sub-section (1) of section 39 and whose registration has been cancelled shall furnish online on the GST Portal, a final return within three months of the date of cancellation or date of order of cancellation, whichever is later, in GST FORM GSTR-10 as specified in Rule 81”

Issues/ Concerns:

- a. Cancellation of registration from an earlier date: If cancellation of registration is permitted from anterior (earlier) date, it would lead to disruption of whole credit chain and difficulties will be faced by persons who have already availed credit.
- b. Commencement of business: In some cases, persons who have obtained voluntary registration may not be able to commence business within 6 months for want of clearance of registration norms,, permissions and requirements etc. from other laws.

Cancellation of such registration without having considered the facts of the case would be unfair.

Statutory Provisions

30. Revocation of cancellation of registration

- (1) *Subject to such conditions as may be prescribed, any registered person, whose registration is cancelled by the proper officer on his own motion, may apply to such officer for revocation of cancellation of the registration in the prescribed manner within thirty days from the date of service of the cancellation order.*
- (2) *The proper officer may, in the manner and within such period as may be prescribed, by order, either revoke cancellation of the registration or reject the application:*
Provided that the application for revocation of cancellation of registration shall not be rejected unless the applicant has been given an opportunity of being heard.
- (3) *The revocation of cancellation of registration under the State Goods and Services Tax Act or the Union Territory Goods and Services Tax Act, as the case may be, shall be deemed to be a revocation of cancellation of registration under this Act.*

Extract of the CGST Rules, 2017

23. Revocation of cancellation of registration

- (1) *A registered person, whose registration is cancelled by the proper officer on his own motion, may submit an application for revocation of cancellation of registration, in FORM GST REG-21, to such proper officer, within a period of thirty days from the date of the service of the order of cancellation of registration at the common portal, either directly or through a Facilitation Centre notified by the Commissioner:*
Provided that no application for revocation shall be filed, if the registration has been cancelled for the failure of the registered person to furnish returns, unless such returns are furnished and any amount due as tax, in terms of such returns, has been paid along with any amount payable towards interest, penalty and late fee in respect of the said returns.
- (2)
 - (a) *Where the proper officer is satisfied, for reasons to be recorded in writing, that there are sufficient grounds for revocation of cancellation of registration, he shall revoke the cancellation of registration by an order in FORM GST REG-22 within a period of thirty days from the date of the receipt of the application and communicate the same to the applicant.*
 - (b) *The proper officer may, for reasons to be recorded in writing, under circumstances other than those specified in clause (a), by an order in FORM GST REG-05, reject the application for revocation of cancellation of registration and communicate the same to the applicant.*

- (3) *The proper officer shall, before passing the order referred to in clause (b) of sub-rule (2), issue a notice in FORM GST REG-23 requiring the applicant to show cause as to why the application submitted for revocation under sub-rule (1) should not be rejected and the applicant shall furnish the reply within a period of seven working days from the date of the service of the notice in FORM GST REG-24.*
- (4) *Upon receipt of the information or clarification in FORM GST REG-24, the proper officer shall proceed to dispose of the application in the manner specified in sub-rule (2) within a period of thirty days from the date of the receipt of such information or clarification from the applicant.*

Relevant circulars, notifications, clarifications, flyers issued by Government: -

- Chapter Two of the compilation of the GST Flyers titled 'Cancellation of Registration in GST', as issued by the CBIC (erstwhile CBEC).

Related provisions of the Statute:

Section or Rule	Description
Section 22	Persons liable for registration
Section 24	Compulsory registration in certain cases
Section 25	Procedure for registration
Section 29	Cancellation of registration

30.1 Analysis

Any registered taxable person, whose registration is cancelled, subject to prescribed conditions and circumstances, may apply to proper officer for revocation of cancellation of the registration within 30 days from the date of service of the cancellation order. The proper officer may in prescribed manner and within prescribed period, by an order, either revoke cancellation of the registration, or reject the application for revocation for good and sufficient reasons.

The proper officer shall not reject the application for revocation of cancellation of registration without giving a show cause notice and without giving the person a reasonable opportunity of being heard.

Revocation of cancellation of registration under State Goods and Services Tax Act or the Union Territory Goods and Services Tax Act shall be deemed to be a revocation of cancellation of registration under the Central Goods and Services Tax Act.

Rule 23 of the CGST Rules, 2017, provides for process of revocation of cancellation of registration and includes the following:

- Application for revocation or cancellation of registration shall be made within 30 days of date of service of cancellation order..

- No application for revocation shall be filed, if the registration has been cancelled for the failure to furnish returns, unless such returns are furnished and any amount due as tax, in terms of such returns, has been paid along with any amount payable towards interest, penalty and late fee in respect of the said returns.
- Revocation of cancellation under CGST will be a deemed revocation under SGST and *vice-versa*.
- Upon receipt of the information or clarification, the proper officer shall proceed to dispose of the application within a period of thirty days from the date of the receipt of such information or clarification from the applicant.

Rule 26 of the CGST Rules, 2017, provides for the method of authentication:

All applications, including reply, if any, to the notices, returns including the details of outward and inward supplies, appeals or any other document required to be submitted under the provisions of these rules shall be so submitted electronically with digital signature certificate or through e-signature as specified under the provisions of the Information Technology Act, 2000 or verified by any other mode of signature or verification as notified by the Board in this behalf. Provided that a registered person registered under the provisions of the Companies Act, 2013 shall furnish the documents or application verified through digital signature certificate.

Each document including the return furnished online shall be signed or verified through electronic verification code-

- (a) in the case of an individual, by the individual himself or where he is absent from India, by some other person duly authorized by him in this behalf, and where the individual is mentally incapacitated from attending to his affairs, by his guardian or by any other person competent to act on his behalf;
- (b) in the case of a HUF, by a Karta and where the Karta is absent from India or is mentally incapacitated from attending to his affairs, by any other adult member of such family or by the authorized signatory of such Karta;
- (c) in the case of a Company, by the chief executive officer or authorized signatory thereof;
- (d) in the case of a Government or any Governmental agency or local authority, by an officer authorized in this behalf;
- (e) in the case of a firm, by any partner thereof, not being a minor or authorized signatory thereof;
- (f) in the case of any other association, by any member of the association or persons or authorized signatory thereof;
- (g) in the case of a trust, by the trustee or any trustee or authorized signatory thereof; or
- (h) in the case of any other person, by some person competent to act on his behalf, or by a person authorized in accordance with the provisions of section 48.

It is also provided that all notices, certificates and orders under the provisions of this Chapter shall be issued electronically by the proper officer or any other officer authorised to issue such notices or certificates or orders, through digital signature certificate or through E-signature as specified under the provisions of the Information Technology Act, 2000 (21 of 2000) or verified by any other mode of signature or verification as notified by the Board in this behalf.

30.2 Comparative Review

Under erstwhile law, the threshold limit for registration under Central Excise was ₹ 1.5 crore (this is optional), under service tax was ₹ 10 lacs and under many State VAT laws between ₹ 5 – 10 lacs.

Section in CGST Act	Title	Corresponding Section in Central Excise Act, 1944	Corresponding Section in Finance Act, 1994	VAT/New Provision
22	Registrations	Section 6 of CEA, 1944 read with Rule 9 of Central Excise Rules, 2002	Section 69 of the Finance Act, 1994 read with Rule 4 of Service Tax Rules, 1994	Different States have different provisions under their Acts.

30.3 FAQs

- Q1. Who is the person liable to take a registration under the GST Law?
- Ans. In terms of sub-sections (1) of sections 22 of the CGST Act, every supplier making taxable supplies is liable for registration if his aggregate turnover in a financial year exceeds ` 20 lakhs.
- Q2. What is the time limit for taking a registration under GST Law?
- Ans. Every person should take registration, within 30 days from the date on which he becomes liable for registration, in such manner and subject to such conditions as may be prescribed. Provided casual taxable person or a non-resident taxable person shall apply for registration at least five days prior to the commencement of business.
- Q3. If a person is operating in different States, with the same PAN, whether he can operate with a single registration?
- Ans. Every person who is liable to take a registration will have to get registered separately for each of the States where he has a business operation and is liable to pay GST in terms of sub-section (1) of sections 25 of GST Law.
- Q4. Whether a person having multiple places of place of business in a State can obtain different registrations?
- Ans. In terms of sub-sections (2) of sections 25, a person having multiple places of business in a State may obtain a separate registration for each such place of business, subject to such conditions as may be prescribed.

- Q5. Is there a provision for a person to get himself registered voluntarily though he may not be liable to pay GST?
- Ans. In terms of sub-section (3) of section 25 a person, though not liable to be registered under section 22, may get himself registered voluntarily, and all provisions of this Act, as are applicable to a registered taxable person, shall apply to such person.
- Q6. Is possession of a Permanent Account Number (PAN) mandatory for obtaining a registration?
- Ans. Every person shall have a Permanent Account Number issued under the Income Tax Act, 1961 (43 of 1961) in order to be eligible for grant of registration under section 22 of the Act.
- Q7. Whether the department through the proper officer, *suo-moto* proceed with registration of a person under this Act?
- Ans. In terms of sub-sections 8 of sections 25, where a person who is liable to be registered under this Act fails to obtain registration, the proper officer may, without prejudice to any action that is, or may be taken under this Act, or under any other law for the time being in force, proceed to register such person in the manner as may be prescribed.
- Q8. When the proper officer can grant a certificate for registration?
- Ans. In terms of sub-sections 10 of sections 25, the registration certificate, shall be granted or rejected after due verification in the manner and within such period as may be prescribed.
- Q9. Whether the registration granted to any person is permanent?
- Ans. Yes, the registration certificate once granted is permanent unless surrendered or cancelled.
- Q10. What is the validity period of the registration certificate issued to casual taxable person and non-resident taxable person?
- Ans. The certificate of registration issued to a "casual taxable person" or a "non-resident taxable person" shall be valid for a period of 90 days from the effective date of registration. A proviso has been made available in this statute by enshrining a discretionary power with the proper officer, who may at the request of the said taxable person, extend the validity of the aforesaid period of 90 days by a further period not exceeding 90 days.
- Q.11. Is there any advance tax to be paid by casual taxable person and non-resident taxable person at the time of obtaining registration under this special category?
- Ans. Yes, it has been made mandatory in the Act, that a casual taxable person or a non-resident taxable person shall, at the time of submission of application for registration under sub-section (2) of section 27, make an advance deposit of tax in an amount equivalent to the estimated tax liability of such person for the period for which the

registration is sought. This provision of depositing advance additional amount of tax equivalent to the estimated tax liability of such person is applicable for the period for which the extension beyond 90 days is being sought.

Q12. Whether amendments to the Registration Certificates issued by the proper officer is permissible?

Ans. In terms of sections 28, the proper officer may, on the basis of such information furnished either by the registrant or as ascertained by him, approve or reject amendments in the registration particulars in the manner and within such period as may be prescribed..

Q13. Whether cancellation of registration certificate is permissible?

Ans. Any registration granted under this Act may be cancelled by the proper officer, on various circumstances and the provisions of the law on this subject have been outlined under sections 29 of the Act. The proper officer may, either on his own motion or on an application filed, in the prescribed manner, by the registered taxable person or by his legal heirs, in case of death of such person, cancel the registration, in such manner and within such period as may be prescribed.

Q14. Whether cancellation of registration under CGST Act means cancellation under SGST Act also?

Ans. The cancellation of registration under the CGST Act /SGST Act shall be deemed to be a cancellation of registration under the SGST Act / CGST Act respectively.

Q.15. Can the proper officer cancel the registration on his own?

Ans. Yes, the proper officer can cancel the registration once issued on his own volition. However, such officer must follow the principles of natural justice by issuing a notice and providing opportunity of being heard.

Q.16. Is registration mandatory for a person making inter-State supplies?

Ans. Registration is mandatory only for persons making inter-State supply of goods; irrespective of the fact that the aggregate turnover computed on all India basis does not exceed ₹ 20 lakhs. Persons making inter-State supply of services whose aggregate turnover on all India basis does not exceed ₹ 20 lakhs is exempted from registration *vide* Notification No. 10/ 2017 – Integrated Tax, dated 13 October 2017 as amended *vide* Notification No. 3/2019-Integrated Tax, dated 29-Jan-2019, w.e.f. 1-Feb-2019. However, in respect of persons making supplies from special category States as mentioned in Article 279A (4)(g) of the Constitution of India, Arunachal Pradesh, Assam, Himachal Pradesh, Meghalaya, Sikkim and Uttarakhand, amount of aggregate turnover shall not exceed ₹ 10 lakhs.

Chapter 8

Tax Invoice, Credit and Debit Notes

Sections	Rules
31. Tax Invoice	46. Tax Invoice
32. Prohibition of unauthorized collection of tax	46A. Invoice-cum-bill of supply
33. Amount of tax to be indicated in tax invoice and other documents	47. Time limit for issuing tax invoice
34. Credit and debit notes	48. Manner of issuing invoice
	49. Bill of supply
	50. Receipt voucher
	51. Refund voucher
	52. Payment voucher
	53. Revised tax invoice and credit or debit notes
	54. Tax invoice in special cases
	55. Transportation of goods without issue of invoice
	55A. Tax invoice or bill of supply to accompany transport of goods

Statutory Provisions

<p>31. Tax invoice</p> <p>(1) <i>A registered person supplying taxable goods shall, before or at the time of,—</i></p> <p>(a) <i>removal of goods for supply to the recipient, where the supply involves movement of goods; or</i></p> <p>(b) <i>delivery of goods or making available thereof to the recipient, in any other case,</i></p> <p><i>issue a tax invoice showing the description, quantity and value of goods, the tax charged thereon and such other particulars as may be prescribed:</i></p> <p><i>Provided that the Government may, on the recommendations of the Council, by notification, specify the categories of goods or supplies in respect of which a tax invoice shall be issued, within such time and in such manner as may be prescribed.</i></p> <p>(2) <i>A registered person supplying taxable services shall, before or after the provision of</i></p>

service but within a prescribed period, issue a tax invoice, showing the description, value, tax charged thereon and such other particulars as may be prescribed:

Provided that the Government may, on the recommendations of the Council, by notification and subject to such conditions as may be mentioned therein, specify the categories of services in respect of which—

- (a) any other document issued in relation to the supply shall be deemed to be a tax invoice; or*
- (b) tax invoice may not be issued.*

(3) Notwithstanding anything contained in sub-sections (1) and (2)—

- (a) a registered person may, within one month from the date of issuance of certificate of registration and in such manner as may be prescribed, issue a revised invoice against the invoice already issued during the period beginning with the effective date of registration till the date of issuance of certificate of registration to him;*
- (b) a registered person may not issue a tax invoice if the value of the goods or services or both supplied is less than two hundred rupees subject to such conditions and in such manner as may be prescribed;*
- (c) a registered person supplying exempted goods or services or both or paying tax under the provisions of section 10 shall issue, instead of a tax invoice, a bill of supply containing such particulars and in such manner as may be prescribed:*

Provided that the registered person may not issue a bill of supply if the value of the goods or services or both supplied is less than two hundred rupees subject to such conditions and in such manner as may be prescribed;

- (d) a registered person shall, on receipt of advance payment with respect to any supply of goods or services or both, issue a receipt voucher or any other document, containing such particulars as may be prescribed, evidencing receipt of such payment;*
- (e) where, on receipt of advance payment with respect to any supply of goods or services or both the registered person issues a receipt voucher, but subsequently no supply is made and no tax invoice is issued in pursuance thereof, the said registered person may issue to the person who had made the payment, a refund voucher against such payment;*
- (f) a registered person who is liable to pay tax under sub-section (3) or sub-section (4) of section 9 shall issue an invoice in respect of goods or services or both received by him from the supplier who is not registered on the date of receipt of goods or services or both;*

- (g) a registered person who is liable to pay tax under sub-section (3) or sub-section (4) of section 9 shall issue a payment voucher at the time of making payment to the supplier.
- (4) In case of continuous supply of goods, where successive statements of accounts or successive payments are involved, the invoice shall be issued before or at the time each such statement is issued or, as the case may be, each such payment is received.
- (5) Subject to the provisions of clause (d) of sub-section (3), in case of continuous supply of services,—
- (a) where the due date of payment is ascertainable from the contract, the invoice shall be issued on or before the due date of payment;
- (b) where the due date of payment is not ascertainable from the contract, the invoice shall be issued before or at the time when the supplier of service receives the payment;
- (c) where the payment is linked to the completion of an event, the invoice shall be issued on or before the date of completion of that event.
- (6) In a case where the supply of services ceases under a contract before the completion of the supply, the invoice shall be issued at the time when the supply ceases and such invoice shall be issued to the extent of the supply made before such cessation.
- (7) Notwithstanding anything contained in sub-section (1), where the goods being sent or taken on approval for sale or return are removed before the supply takes place, the invoice shall be issued before or at the time of supply or six months from the date of removal, whichever is earlier.
- Explanation.* —For the purposes of this section, the expression “tax invoice” shall include any revised invoice issued by the supplier in respect of a supply made earlier.

Extract of the CGST Rules, 2017**46. Tax invoice**

Subject to rule 54, a tax invoice referred to in section 31 shall be issued by the registered person containing the following particulars, namely,-

- (a) name, address and Goods and Services Tax Identification Number of the supplier;
- (b) a consecutive serial number not exceeding sixteen characters, in one or multiple series, containing alphabets or numerals or special characters- hyphen or dash and slash symbolised as ‘_’ and “/” respectively, and any combination thereof, unique for a financial year;
- (c) date of its issue;

- (d) name, address and Goods and Services Tax Identification Number or Unique Identity Number, if registered, of the recipient;
- (e) name and address of the recipient and the address of delivery, along with the name of the State and its code, if such recipient is un-registered and where the value of the taxable supply is fifty thousand rupees or more;
- (f) name and address of the recipient and the address of delivery, along with the name of the State and its code, if such recipient is un-registered and where the value of the taxable supply is less than fifty thousand rupees and the recipient requests that such details be recorded in the tax invoice;
- (g) Harmonised System of Nomenclature code for goods or services;
- (h) description of goods or services;
- (i) quantity in case of goods and unit or Unique Quantity Code thereof;
- (j) total value of supply of goods or services or both;
- (k) taxable value of the supply of goods or services or both taking into account discount or abatement, if any;
- (l) rate of tax (central tax, State tax, integrated tax, Union territory tax or cess);
- (m) amount of tax charged in respect of taxable goods or services (central tax, State tax, integrated tax, Union territory tax or cess);
- (n) place of supply along with the name of the State, in the case of a supply in the course of inter-State trade or commerce;
- (o) address of delivery where the same is different from the place of supply;
- (p) whether the tax is payable on reverse charge basis; and
- (q) signature or digital signature of the supplier or his authorised representative:

Provided that the Board may, on the recommendations of the Council, by notification, specify-

- (i) the number of digits of Harmonised System of Nomenclature code for goods or services that a class of registered persons shall be required to mention, for such period as may be specified in the said notification; and
- (ii) the class of registered persons that would not be required to mention the Harmonised System of Nomenclature code for goods or services, for such period as may be specified in the said notification:

Provided further that where an invoice is required to be issued under clause (f) of sub-section (3) of section 31, a registered person may issue a consolidated invoice at the end of a month for supplies covered under sub-section (4) of section 9, the aggregate value of such supplies exceeds rupees five thousand in a day from any or all the suppliers:

Provided also that in the case of the export of goods or services, the invoice shall carry an endorsement "SUPPLY MEANT FOR EXPORT/SUPPLY TO SEZ UNIT OR SEZ DEVELOPER FOR AUTHORISED OPERATIONS ON PAYMENT OF INTEGRATED TAX" or "SUPPLY MEANT FOR EXPORT/SUPPLY TO SEZ UNIT OR SEZ DEVELOPER FOR AUTHORISED OPERATIONS UNDER BOND OR LETTER OF UNDERTAKING WITHOUT PAYMENT OF INTEGRATED TAX", as the case may be, and shall, in lieu of the details specified in clause (e), contain the following details, namely,- (i) name and address of the recipient; (ii) address of delivery; and (iii) name of the country of destination:

Provided also that a registered person may not issue a tax invoice in accordance with the provisions of clause (b) of sub-section (3) of section 31 subject to the following conditions, namely,-

- (a) the recipient is not a registered person; and*
- (b) the recipient does not require such invoice, and*

shall issue a consolidated tax invoice for such supplies at the close of each day in respect of all such supplies.

Provided also that the signature or digital signature of the supplier or his authorised representative shall not be required in the case of issuance of an electronic invoice in accordance with the provisions of the Information Technology Act, 2000 (21 of 2000).

46A. Invoice-cum-bill of supply

Notwithstanding anything contained in rule 46 or rule 49 or rule 54, where a registered person is supplying taxable as well as exempted goods or services or both to an unregistered person, a single "invoice-cum-bill of supply" may be issued for all such supplies.

47. Time limit for issuing tax invoice

The invoice referred to in rule 46, in the case of the taxable supply of services, shall be issued within a period of thirty days from the date of the supply of service:

Provided that where the supplier of services is an insurer or a banking company or a financial institution, including a non-banking financial company, the period within which the invoice or any document in lieu thereof is to be issued shall be forty-five days from the date of the supply of service:

Provided further that an insurer or a banking company or a financial institution, including a non-banking financial company, or a telecom operator, or any other class of supplier of services as may be notified by the Government on the recommendations of the Council, making taxable supplies of services between distinct persons as specified in section 25, may issue the invoice before or at the time such supplier records the same in his books of account or before the expiry of the quarter during which the supply was made.

48. Manner of issuing invoice

- (1) *The invoice shall be prepared in triplicate, in the case of supply of goods, in the following manner, namely,-*
- (a) *the original copy being marked as ORIGINAL FOR RECIPIENT;*
 - (b) *the duplicate copy being marked as DUPLICATE FOR TRANSPORTER; and*
 - (c) *the triplicate copy being marked as TRIPLICATE FOR SUPPLIER.*
- (2) *The invoice shall be prepared in duplicate, in the case of the supply of services, in the following manner, namely,-*
- (a) *the original copy being marked as ORIGINAL FOR RECIPIENT; and*
 - (b) *the duplicate copy being marked as DUPLICATE FOR SUPPLIER.*
- (3) *The serial number of invoices issued during a tax period shall be furnished electronically through the common portal in FORM GSTR-1.*

49. Bill of supply

A bill of supply referred to in clause (c) of sub-section (3) of section 31 shall be issued by the supplier containing the following details, namely,-

- (a) *name, address and Goods and Services Tax Identification Number of the supplier;*
- (b) *a consecutive serial number not exceeding sixteen characters, in one or multiple series, containing alphabets or numerals or special characters -hyphen or dash and slash symbolised as “-” and “/” respectively, and any combination thereof, unique for a financial year;*
- (c) *date of its issue;*
- (d) *name, address and Goods and Services Tax Identification Number or Unique Identity Number, if registered, of the recipient;*
- (e) *Harmonised System of Nomenclature Code for goods or services;*
- (f) *description of goods or services or both;*
- (g) *value of supply of goods or services or both taking into account discount or abatement, if any; and*
- (h) *signature or digital signature of the supplier or his authorised representative:*

Provided that the provisos to rule 46 shall, mutatis mutandis, apply to the bill of supply issued under this rule:

Provided further that any tax invoice or any other similar document issued under any other Act for the time being in force in respect of any non-taxable supply shall be treated as a bill of supply for the purposes of the Act.

Provided also that the signature or digital signature of the supplier or his authorised representative shall not be required in the case of issuance of an electronic bill of supply in accordance with the provisions of the Information Technology Act, 2000 (21 of 2000).

50. Receipt voucher

A receipt voucher referred to in clause (d) of sub-section (3) of section 31 shall contain the following particulars, namely,-

- (a) name, address and Goods and Services Tax Identification Number of the supplier;*
- (b) a consecutive serial number not exceeding sixteen characters, in one or multiple series, containing alphabets or numerals or special characters-hyphen or dash and slash symbolised as “-” and “/” respectively, and any combination thereof, unique for a financial year;*
- (c) date of its issue;*
- (d) name, address and Goods and Services Tax Identification Number or Unique Identity Number, if registered, of the recipient;*
- (e) description of goods or services;*
- (f) amount of advance taken;*
- (g) rate of tax (central tax, State tax, integrated tax, Union territory tax or cess);*
- (h) amount of tax charged in respect of taxable goods or services (central tax, State tax, integrated tax, Union territory tax or cess);*
- (i) place of supply along with the name of State and its code, in case of a supply in the course of inter-State trade or commerce;*
- (j) whether the tax is payable on reverse charge basis; and*
- (k) signature or digital signature of the supplier or his authorised representative:*

Provided that where at the time of receipt of advance,-

- (i) the rate of tax is not determinable, the tax shall be paid at the rate of eighteen per cent.;*
- (ii) the nature of supply is not determinable, the same shall be treated as inter-State supply.*

51. Refund voucher

A refund voucher referred to in clause (e) of sub-section (3) of section 31 shall contain the following particulars, namely:-

- (a) name, address and Goods and Services Tax Identification Number of the supplier;*
- (b) a consecutive serial number not exceeding sixteen characters, in one or multiple series, containing alphabets or numerals or special characters-hyphen or dash and*

<p>slash symbolised as “-” and “/” respectively, and any combination thereof, unique for a financial year;</p> <p>(c) date of its issue;</p> <p>(d) name, address and Goods and Services Tax Identification Number or Unique Identity Number, if registered, of the recipient;</p> <p>(e) number and date of receipt voucher issued in accordance with the provisions of rule 50;</p> <p>(f) description of goods or services in respect of which refund is made;</p> <p>(g) amount of refund made;</p> <p>(h) rate of tax (central tax, State tax, integrated tax, Union territory tax or cess);</p> <p>(i) amount of tax paid in respect of such goods or services (central tax, State tax, integrated tax, Union territory tax or cess);</p> <p>(j) whether the tax is payable on reverse charge basis; and</p> <p>(k) signature or digital signature of the supplier or his authorised representative.</p>
<p>52. Payment voucher</p> <p>A payment voucher referred to in clause (g) of sub-section (3) of section 31 shall contain the following particulars, namely:-</p> <p>(a) name, address and Goods and Services Tax Identification Number of the supplier if registered;</p> <p>(b) a consecutive serial number not exceeding sixteen characters, in one or multiple series, containing alphabets or numerals or special characters-hyphen or dash and slash symbolised as “-” and “/” respectively, and any combination thereof, unique for a financial year;</p> <p>(c) date of its issue;</p> <p>(d) name, address and Goods and Services Tax Identification Number of the recipient;</p> <p>(e) description of goods or services;</p> <p>(f) amount paid;</p> <p>(g) rate of tax (central tax, State tax, integrated tax, Union territory tax or cess);</p> <p>(h) amount of tax payable in respect of taxable goods or services (central tax, State tax, integrated tax, Union territory tax or cess);</p> <p>(i) place of supply along with the name of State and its code, in case of a supply in the course of inter-State trade or commerce; and</p> <p>(j) signature or digital signature of the supplier or his authorised representative.</p>

53. Revised tax invoice and credit or debit notes

- (1) A revised tax invoice referred to in section 31 shall contain the following particulars, namely:-
- (a) the word – "Revised Invoice", wherever applicable, indicated prominently;
 - (b) name, address and Goods and Services Tax Identification Number of the supplier;
 - (c) a consecutive serial number not exceeding sixteen characters, in one or multiple series, containing alphabets or numerals or special characters-hyphen or dash and slash symbolised as "-" and "/" respectively, and any combination thereof, unique for a financial year;
 - (d) date of issue of the document;
 - (e) name, address and Goods and Services Tax Identification Number or Unique Identity Number, if registered, of the recipient;
 - (f) name and address of the recipient and the address of delivery, along with the name of State and its code, if such recipient is un-registered;
 - (g) serial number and date of the corresponding tax invoice or, as the case may be, bill of supply;
 - (h) signature or digital signature of the supplier or his authorised representative.

(1A) A credit or debit note referred to in section 34 shall contain the following particulars, namely:-

- (a) name, address and Goods and Services Tax Identification Number of the supplier;
- (b) nature of the document;
- (c) a consecutive serial number not exceeding sixteen characters, in one or multiple series, containing alphabets or numerals or special characters-hyphen or dash and slash symbolised as "-" and "/" respectively, and any combination thereof, unique for a financial year;
- (d) date of issue of the document;
- (e) name, address and Goods and Services Tax Identification Number or Unique Identity Number, if registered, of the recipient;
- (f) name and address of the recipient and the address of delivery, along with the name of State and its code, if such recipient is un-registered;
- (g) serial number(s) and date(s) of the corresponding tax invoice(s) or, as the case may be, bill(s) of supply;

- (h) value of taxable supply of goods or services, rate of tax and the amount of the tax credited or, as the case may be, debited to the recipient; and
- (i) signature or digital signature of the supplier or his authorised representative.
- (2) Every registered person who has been granted registration with effect from a date earlier than the date of issuance of certificate of registration to him, may issue revised tax invoices in respect of taxable supplies effected during the period starting from the effective date of registration till the date of the issuance of the certificate of registration:
- Provided that the registered person may issue a consolidated revised tax invoice in respect of all taxable supplies made to a recipient who is not registered under the Act during such period:*
- Provided further that in the case of inter-State supplies, where the value of a supply does not exceed two lakh and fifty thousand rupees, a consolidated revised invoice may be issued separately in respect of all the recipients located in a State, who are not registered under the Act.*
- (3) Any invoice or debit note issued in pursuance of any tax payable in accordance with the provisions of section 74 or section 129 or section 130 shall prominently contain the words "INPUT TAX CREDIT NOT ADMISSIBLE".

54. Tax invoice in special cases

- (1) An Input Service Distributor invoice or, as the case may be, an Input Service Distributor credit note issued by an Input Service Distributor shall contain the following details:-
- (a) name, address and Goods and Services Tax Identification Number of the Input Service Distributor;
- (b) a consecutive serial number not exceeding sixteen characters, in one or multiple series, containing alphabets or numerals or special characters-hyphen or dash and slash symbolised as "-", "/" respectively, and any combination thereof, unique for a financial year;
- (c) date of its issue;
- (d) name, address and Goods and Services Tax Identification Number of the recipient to whom the credit is distributed;
- (e) amount of the credit distributed; and
- (f) signature or digital signature of the Input Service Distributor or his authorised representative:

Provided that where the Input Service Distributor is an office of a banking company or a financial institution, including a non-banking financial company, a tax invoice shall include any document in lieu thereof, by whatever name called, whether or not serially numbered but containing the information as mentioned above.

- (1A) (a) *A registered person, having the same PAN and State code as an Input Service Distributor, may issue an invoice or, as the case may be, a credit or debit note to transfer the credit of common input services to the Input Service Distributor, which shall contain the following details:-*
- i. name, address and Goods and Services Tax Identification Number of the registered person having the same PAN and same State code as the Input Service Distributor;*
 - ii. a consecutive serial number not exceeding sixteen characters, in one or multiple series, containing alphabets or numerals or special characters - hyphen or dash and slash symbolised as “-” and “/” respectively, and any combination thereof, unique for a financial year;*
 - iii. date of its issue;*
 - iv. Goods and Services Tax Identification Number of supplier of common service and original invoice number whose credit is sought to be transferred to the Input Service Distributor;*
 - v. name, address and Goods and Services Tax Identification Number of the Input Service Distributor;*
 - vi. taxable value, rate and amount of the credit to be transferred; and*
 - vii. signature or digital signature of the registered person or his authorised representative.*
- (b) *The taxable value in the invoice issued under clause (a) shall be the same as the value of the common services.*
- (2) *Where the supplier of taxable service is an insurer or a banking company or a financial institution, including a non-banking financial company, the said supplier [may] issue a [consolidated] tax invoice or any other document in lieu thereof, by whatever name called [for the supply of services made during a month at the end of the month], whether issued or made available, physically or electronically whether or not serially numbered, and whether or not containing the address of the recipient of taxable service but containing other information as mentioned under rule 46.*

Provided that the signature or digital signature of the supplier or his authorised representative shall not be required in the case of issuance of a consolidated tax

invoice or any other document in lieu thereof in accordance with the provisions of the Information Technology Act, 2000 (21 of 2000).

(3) *Where the supplier of taxable service is a goods transport agency supplying services in relation to transportation of goods by road in a goods carriage, the said supplier shall issue a tax invoice or any other document in lieu thereof, by whatever name called, containing the gross weight of the consignment, name of the consigner and the consignee, registration number of goods carriage in which the goods are transported, details of goods transported, details of place of origin and destination, Goods and Services Tax Identification Number of the person liable for paying tax whether as consigner, consignee or goods transport agency, and also containing other information as mentioned under rule 46.*

(4) *Where the supplier of taxable service is supplying passenger transportation service, a tax invoice shall include ticket in any form, by whatever name called, whether or not serially numbered, and whether or not containing the address of the recipient of service but containing other information as mentioned under rule 46.*

Provided that the signature or digital signature of the supplier or his authorised representative shall not be required in the case of issuance of ticket in accordance with the provisions of the Information Technology Act, 2000 (21 of 2000).

(5) *The provisions of sub-rule (2) or sub-rule (4) shall apply, mutatis mutandis, to the documents issued under rule 49 or rule 50 or rule 51 or rule 52 or rule 53.*

55. Transportation of goods without issue of invoice

(1) *For the purposes of-*

- (a) *supply of liquid gas where the quantity at the time of removal from the place of business of the supplier is not known,*
- (b) *transportation of goods for job work,*
- (c) *transportation of goods for reasons other than by way of supply, or*
- (d) *such other supplies as may be notified by the Board,*

the consigner may issue a delivery challan, serially numbered not exceeding sixteen characters, in one or multiple series, in lieu of invoice at the time of removal of goods for transportation, containing the following details, namely:-

- (i) *date and number of the delivery challan;*
- (ii) *name, address and Goods and Services Tax Identification Number of the consigner, if registered;*
- (iii) *name, address and Goods and Services Tax Identification Number or Unique Identity Number of the consignee, if registered;*
- (iv) *Harmonised System of Nomenclature code and description of goods;*

- (v) quantity (provisional, where the exact quantity being supplied is not known);
 - (vi) taxable value;
 - (vii) tax rate and tax amount – central tax, State tax, integrated tax, Union territory tax or cess, where the transportation is for supply to the consignee;
 - (viii) place of supply, in case of inter-State movement; and
 - (ix) signature.
- (2) The delivery challan shall be prepared in triplicate, in case of supply of goods, in the following manner, namely:–
- (a) the original copy being marked as ORIGINAL FOR CONSIGNEE;
 - (b) the duplicate copy being marked as DUPLICATE FOR TRANSPORTER; and
 - (c) the triplicate copy being marked as TRIPLICATE FOR CONSIGNER.
- (3) Where goods are being transported on a delivery challan in lieu of invoice, the same shall be declared as specified in rule 138.
- (4) Where the goods being transported are for the purpose of supply to the recipient but the tax invoice could not be issued at the time of removal of goods for the purpose of supply, the supplier shall issue a tax invoice after delivery of goods.
- (5) Where the goods are being transported in a semi knocked down or completely knocked down condition or in batches or lots -
- (a) the supplier shall issue the complete invoice before dispatch of the first consignment;
 - (b) the supplier shall issue a delivery challan for each of the subsequent consignments, giving reference of the invoice;
 - (c) each consignment shall be accompanied by copies of the corresponding delivery challan along with a duly certified copy of the invoice; and
 - (d) the original copy of the invoice shall be sent along with the last consignment.

55A. Tax Invoice or bill of supply to accompany transport of goods

The person-in-charge of the conveyance shall carry a copy of the tax invoice or the bill of supply issued in accordance with the provisions of rules 46, 46A or 49 in a case where such person is not required to carry an e-way bill under these rules.

Relevant circulars, notifications, clarifications issued by Government:

Annexure to Notification No. 11/2017-Central Tax (Rate) dt.28.06.2017 for scheme of classification of services

Notification 12/2017 – Central Tax dated 28.06.2017 regarding disclosure of HSN in the tax invoice

Notification 45/2017 – Central Tax dated 13.10.2017 Regarding issue of consolidated tax

invoice

Notification No. 38/2017 – Central Tax (Rate) dated 13.10.2017 read with Notification No. 10/2018 –Central Tax (Rate) dated 23.03.2018; Notification No. 12/2018 –Central Tax (Rate) dated 29.06.2018 and Notification No. 22/2018 –Central Tax (Rate) dated 6.08.2018 for exemption of tax payable under Section 9(4) on reverse charge basis. Further, Notification No. 01/2019-Central Tax (Rate), dt. 29-01-2019 which rescinds Notification No. 8/2017-Central Tax (Rate), dt. 28.06.2017, in view of bringing into effect the amendments (regarding RCM on supplies by unregistered persons) in the GST Acts

Circular 10/2017 dated 18.10.2017 for clarification where the goods are moved within the state or from the State of registration to another State for supply on approval basis

Circular 38/2018 dated 26.03.2018 regarding issued related to job work

Notification 39/2018- Central Tax dated 04.09.2018 regarding insertion of words “or in batches or lots” in Rule 55(5).

Chapter Thirteen of the compilation of the GST Flyers as issued by the CBIC can be referred to for a gist of the statutory provisions, titled ‘Tax Invoice and other such instruments in GST’

Circular 72/46/2018 dated 26.10.18 for clarification of procedure in respect of return of time expired drugs or medicine.

Notification no. 74/2018-Central Tax, dt. 31-12-2018 regarding Fourteenth amendment to the CGST Rules, 2017

Notification no 02/2019-Central Tax, dt. 29-01-2019 which seeks to bring into force the CGST (Amendment) Act, 2018

Notification no 03/2019-Central Tax, dt. 29-01-2019 regarding to amend the CGST Rules, 2017

Related provisions of the Statute:

Section or Rule	Description
Section 2(94)	Definition of Registered person
Section 2(32)	Definition of Continuous supply of goods
Section 2(33)	Definition of Continuous supply of services
Section 2(41)	Definition of Document
Section 2(66)	Definition of Invoice or Tax Invoice
Section 2(86)	Definition of Place of supply
Section 2(96)	Definition of Removal (in relation to goods)
Section 2(98)	Definition of Reverse charge

Section 2(47)	Definition of Exempt supply
Section 9	Levy and collection
Section 10	Composition levy
Section 15	Value of taxable supply
Section 143	Job work procedure
Rule 39	Procedure for distribution of input tax credit by ISD
Section 68	Inspection of goods in movement
Section 74	Determination of tax not paid or short paid or erroneously refunded or input tax credit wrongly availed or utilised by reason of fraud or any wilful misstatement or suppression of facts.
Section 129	Detention, seizure and release of goods and conveyances in transit.
Section 130	Confiscation of goods or conveyances and levy of penalty.
Rule 138-138D	Chapter XVI – E-way Rules
Section 16 of the IGST Act	Zero-rated supply

31.1 Introduction

An invoice does not bring into existence an agreement but merely records the terms of a pre-existing agreement (oral or written). An invoice can be understood as a document that is meant to serve a particular purpose. The GST Law requires that an invoice – tax invoice or bill of supply – is issued on the occurrence of certain event, being a supply, within the prescribed timelines. Therefore, an invoice, among other documents is required to be issued for every form of supply such as sale, transfer, barter, exchange, license, rental, lease or disposal. This chapter provides an understanding of the various documents required to be issued under the GST law, timelines to issue such document and the contents of every such document.

31.2 Analysis

- A. Tax invoice on supply of goods or services:** Every registered person is required to issue a tax invoice on effecting a taxable outward supply of goods or services.
- a. In order to determine when the tax invoice is to be issued, the supply must be classified into one of these two cases, that is, whether it is case of supply that involves movement or one that does not involve movement of the goods. Timelines for issuance of a tax invoice on the supply of taxable goods:
 - i. Where the supply involves movement of goods: Before or at the time of removal of goods;

- ii. Where the supply does not involve movement of goods: Before or at the time of delivery of the goods / making them available to the recipient.

Please refer to chapter regarding time of supply for a detailed discussion about removal and movement of goods, mode and time of delivery of goods and the role of supplier or recipient in determining the answers to these questions.

- b. It is crucial for the supplier to determine the point of time at which the service is provided. Service being intangible in nature, would throw several challenges in identifying the point of time at which it can be said to be provided / completed. Timelines for issuance of tax invoice on the supply of taxable services:
- i. Before the provision of services; or
 - ii. After the provision of services but within 30 days (or 45 days in case of suppliers of services being an insurer / banking company / financial institution, including a NBFC) from the date of supply of the service; or
 - iii. Before or at the time of supplier records the supplies in his books of account or before the expiry of the quarter during which the supply was made, in case of supply of taxable services between distinct person by an insurer or a banking company or a financial institution, a NBFC, or a telecom operator, or any other class of supplier of services as may be notified by the Government on the recommendations of the Council.
- c. In terms of **Rule 46** of CGST Rules, 2017, a tax invoice referred to in this section shall be issued by the registered person containing all the particulars specified in the said Rule, as applicable to the transaction.

Notes:

- ✓ Where the registered person is engaged in effecting both taxable and exempt supplies, he may title the document 'Tax invoice cum bill of supply' instead of 'tax invoice', ONLY in respect of supplies effected to an unregistered person.
 - ✓ A registered person can issue multiple series of invoices. No application is required to be filed with the Tax office in this regard. However, the suppliers would be required to report the serial numbers (from & to, along with the number of cancellations during the tax period) of all the series of tax invoices (and other documents covered under this Chapter).
- d. The tax invoice must be prepared in triplicate for goods, and in duplicate for services. Each copy of the tax invoice is required to be marked as follows:

Goods	Services
1. ORIGINAL FOR RECIPIENT	1. ORIGINAL FOR RECIPIENT
2. DUPLICATE FOR TRNSPORTER	2. DUPLICATE FOR SUPPLIER
3. TRIPLICATE FOR SUPPLIER	–

- e. As regards the requirement to quote the HSN of the supplies, the annual turnover of the registered person for the previous year shall be referred. In case of suppliers having annual turnover in the previous year:–
- (i) Upto Rs. 1.5 Crore – No HSN required;
 - (ii) Exceeding 1.5 Crore upto Rs. 5 Crore – HSN upto 2 digits required;
 - (iii) Exceeding Rs.5 Crore – HSN upto 4 digits required.

Please note that the term '*annual turnover*' has not been defined. Therefore, it may be understood, to be the Turnover in the State as defined in Section 2(112) of the Act, computed for the preceding financial year.

It is also relevant to note that there has been no notification issued in respect of services, separately. However, considering that the term 'HSN' has been used commonly in respect of both goods and services, the aforesaid order can be applied even in respect of services, while quoting the code from the scheme of Classification of Services, as provided in Notification No. 11/2017-Central Tax (Rate) dt.28.06.2017.

- f. Signature or digital signature of the supplier or his authorised representative shall not be required in the case of issuance of an electronic invoice in accordance with the provisions of the Information Technology Act, 2000 (21 of 2000). [Notification No. 74/2018-Central Tax dated 31.12.2018]

g. **Tax Invoices in cases of outward supply of special services**

Sl. No.	Class of supplier of taxable services	Nature of document	Optional	Mandatory All particulars as specified in Rule 46 other than that specified in 'Optional' column
1	Insurer, Banking Company, Financial Institution and NBFC*	Consolidated Tax Invoice or any other similar document	a. Serial no. b. Address of the recipient of services	Consolidation for the supply of services made during the month, at the end of the month
2	Goods transport agency (GTA) transporting goods by road	Tax Invoice or any other similar document	None	In addition to those cited in Rule 46; a. Gross weight of consignment; b. Name of the Consignor and Consignee; c. Regn. No. of Vehicle;

Sl. No.	Class of supplier of taxable services	Nature of document	Optional	Mandatory All particulars as specified in Rule 46 other than that specified in 'Optional' column
				d. Details of goods transported; e. Origin and destination; f. GSTIN of person liable to pay tax whether as consignor / consignee / GTA.
3	Passenger transport agency*	Tax invoice or ticket	a. Serial no. b. Address of the recipient of services	
* Equally applicable to the documents: Bill of supply, receipt voucher, refund voucher payment voucher, revised tax invoice, debit notes and credit notes.				

- h. Specifically, in case of export of goods or services, the following may be noted:
- (i) The invoice shall carry an endorsement as follows:
1. *Where the supply is effected on payment of IGST:* "Supply meant for export/supply to SEZ unit or SEZ developer for authorised operations on payment of integrated tax" or
 2. *Where the supply is effected without payment of IGST:* "Supply meant for export/supply to SEZ unit or SEZ developer for authorised operations under bond or letter of undertaking without payment of integrated tax".
- (ii) In lieu of the State name & State code, the details of the country of destination would have to be provided.
- i. Special declaration would have to be made on a tax invoice prominently, containing the words "INPUT TAX CREDIT NOT ADMISSIBLE", where any invoice has been issued when tax has been found to be payable in accordance with the provisions of section 74 or section 129 or section 130.
- j. Discount provided before or at the time of supply must be reflected on the face of the tax invoice in order to avail a reduction from the taxable value. Trade discounts not reflected on the face of the invoice would not qualify for such benefit, and therefore, tax on that value would also be payable.

- k. Where an invoice contains multiple goods and / or services, please note that the details would be required to be provided in respect of every line item of the invoice (such as Description, HSN, quantity, unit of measurement, value, discount, increase in value on account of inclusions specified in Section 15(2), taxable value as agreed or as determined in terms of the valuation rules, etc.).
- l. Circular 72/46/2018 dated 26.10.18 issued to clarify the procedure in respect of return of time expired drugs or medicines wherein it is clarified that a person returning the time expired goods may issue the tax invoice or bill of supply, as the case may be in the following manner:
- Return of time expired drugs / medicines may be treated as fresh supply and accordingly, a person returning the goods, if registered may issue tax invoice for return of such drugs / medicines. It is also clarified that a manufacturer accepting the time expired medicines / drugs is entitled to claim the input tax credit of GST mentioned on the tax invoice issued by the registered person returning such goods;
 - In case if the person returning time expired drugs / medicines is a composition tax payer, it is clarified that a bill of supply may be issued for supply-returns. In such a scenario there does not arise a question to claim input tax credit by the manufacturer;
 - In case of unregistered persons, time expired drugs / medicines can be returned by way of issuing any commercial document without charging any tax on the same.
- m. Exception to the rule that every supply must be supported by a tax invoice: A registered person is not required to issue a separate tax invoice in respect of supply of goods and / or services where the value of supply is lower than 200/-, subject to the following conditions:
- (i) the recipient is not a registered person; and
 - (ii) the recipient does not require such invoice; and
 - (iii) the supplier issues a **consolidated tax invoice** for such supplies at the close of each day in respect of all such supplies.
- B. Revised Tax Invoice:** A revised tax invoice in terms of the GST Law is different from what is construed to be a revised tax invoice in common parlance. Therefore, it is made abundantly clear that there is **NO provision under the GST Law for a registered person to revise a tax invoice** which was issued earlier, on account of errors / mistakes in the original tax invoice.
- a. Why a revised tax invoice?
- A person should apply for registration within 30 days of becoming liable for registration under Section 25(1) of the CGST Act. When such an application is made within such time and registration is granted, the effective date of registration

is the date on which the person became liable for registration, thereby resulting in a time lag between the date of grant of certificate of registration and the effective date of registration. For supplies made by such person during this intervening period, the law enables issuance of a revised tax invoice, so that ITC can be availed by the recipient on such supplies.

- b. Accordingly, a revised invoice (carrying the details as specified in Rule 53) may be issued for supplies effected between the effective date of registration and the date of issue of registration certificate.
- c. The GST Law provides for issuance of a consolidated revised tax invoice in case of supplies to unregistered persons (other than in case of inter-State supplies where the value of supply exceeds Rs.2.5 Lakhs), in respect of all taxable supplies made to each recipient, separately.
- d. If issued, it must be issued within one month from the date of registration.

C. Bill of supply: A bill of supply is required to be issued in the following cases:

- a. Where the supplier is a registered person who has opted for composition tax under section 10 of the Act (and shall not charge tax on the bill of supply); or
- b. Where the goods / services being supplied by any registered person are wholly exempted.

The bill of supply is required to contain all the applicable particulars as are specified in **Rule 49** of CGST Rules, 2017.

D. Documents required to be issued in respect of advances received

- a. In case of receipt of advance by a registered person, a '**receipt voucher**' is required to be issued, and not a tax invoice, and it is required to contain all the particulars as are prescribed in **Rule 50** of CGST Rules, 2017. Based on this receipt voucher, the registered person will be required to pay tax on the advances received.
- b. Please note that the receipt voucher would also carry the details of tax applicable on the transaction when the advance so received is liable to tax (as in case of services). However, if the following key factors cannot be determined at the time of receipt of advance, then the following rule would apply:
 - (i) Where the rate of tax is not determinable: Rate to be 18%;
 - (ii) Where the nature of supply is not determinable: Nature to be IGST.
- c. In addition to such receipt voucher, the supplier will be required to issue a **tax invoice** on effecting the supply, containing all the particulars as are required in a case where no advance had been received. In this regard, it may be noted that while the receipt voucher may not be significant where the supply takes place in the same month in which the advance is received, *the law does not exempt one from issuing a receipt voucher in such a scenario.*

- d. Whenever a transaction envisages issue of receipt voucher, and the same is not followed by the issuance of a tax invoice, since it does not translate into a transaction of supply, the receipt voucher issued will need to be reversed (meaning without cancellation of the receipt voucher) by issuing a '**refund voucher**' containing similar particulars, as required under **Rule 51** of the CGST Rules, 2017.

E. Documents required to be issued in respect of supplies liable to tax under reverse charge mechanism

- a. Where tax is payable on reverse charge basis in terms of Section 9(3) or 9(4), or the corresponding provisions of the IGST Act, 2017, the recipient of supply is required to pay tax on reverse charge basis. In this regard, the following may be noted:

Document to be issued by recipient	Supplier is registered	Supplier is not registered
Tax invoice	Not required	Required
Payment voucher	Required	Required

- b. The law makes a provision for the issuance of a **consolidated tax invoice** for every month, to be issued at the end of the month, where the aggregate value of the supplies liable to tax under reverse charge mechanism exceeds Rs.5,000. This apart, a mirrored set of all the particulars specified under **Rule 46** would be required to be contained in a tax invoice issued by a registered recipient (commonly referred to as 'self-invoice' by trade and industry).
- c. All cases of inward supplies on which tax is payable on reverse charge basis, require the recipient of supply to issue a **payment voucher**, at the time of making payment to the supplier, containing all the applicable particulars specified in **Rule 52** of the CGST Rules, 2017.
- d. It is relevant to note here that payment of tax by registered recipients on effecting inward supplies from unregistered, in terms of Section 9(4) of the Act, has been exempted up to 30.09.2019, vide Notification no 8/2017-Central Tax (rate) dated 28.06.2017 as amended time to time, however the said notification is rescinded by notification no 1/2019-Central Tax (Rate) dated 29-01-2019 wef 01.02.2019). Vide the Central Goods and Services Tax Amendment Act, 2018, after amendment of section 9(4) the Government may, on the recommendations of the Council, by notification, specify a class of registered persons who shall, in respect of supply of specified categories of goods or services or both received from an unregistered supplier, pay the tax on reverse charge basis as the recipient of such supply of goods or services or both.

F. Tax Invoice for an Input Service Distributor (ISD):

- a. An Input Service Distributor (ISD) is entitled to distribute credits in terms of Section 20 of the Act read with Rule 39 of the CGST Rules, 2017. For the purpose of such

credit distribution, an ISD Invoice is required to be issued by an ISD (or a credit note where the credit distributed earlier is to be reduced for any reason), and such document is required to contain all the particulars specified in **Rule 54(1)** of the CGST Rules, 2017.

- b. An exception has been carved out for an ISD of a banking company or a financial institution, including a NBFC, wherein the document issued for distribution may or not may not be serially numbered, but must contain all the details as prescribed.
- c. The law provides that a registered person having the same PAN and State code as that of the ISD, may issue an invoice or, as the case may be, a credit or debit note to transfer the credit of common input services to the ISD (wherein the taxable value shall be the same as the value of the common services), containing the details specified in **Rule 54(1A)**. It may be noted that the said sub-rule has been inserted vide Notification No. 03/2018 dated 23.01.2018. By virtue of this provision, certain loopholes of the ISD provisions have been plugged. E.g. Where a common service is liable to tax under reverse charge basis, another registration in the same State can discharge the liability and pass on such details to the ISD for distribution, considering the an ISD is incapable of discharging any tax liability.

G. Delivery challan: Rule 55 of the CGST Rules, 2017 provides for issuance of delivery challan, and also the mandatory contents in a delivery challan. A delivery challan is required to be issued by a registered person every time he moves any goods for any reasons other than by way of supply (say supply for jobwork, goods sent for sale on approval basis, dispatch of demo-goods, disposal by way of gift or free samples, shipment of goods for an exhibition, etc.)

- a. Please note that a delivery challan is a document required for movement of goods, and not “supply of goods”. This means, even where goods that are otherwise chargeable to tax as services, are moved, this document would be required. E.g. Goods moved for works contract purposes, goods sent for hire, etc.
- b. It has been clarified vide Circular No.10/2017 dated 18.10.2017 that where the goods are removed for line sales or for supply on approval basis, the person removing the goods either for intra-State supplies or inter-State supplies shall raise a delivery challan along with e-way bill (if applicable) since the supplier would be unable to ascertain the actual supply at the time of removal. It is also clarified that the person removing the goods shall carry the invoice book during the movement which shall enable him to issue an invoice once the supply is complete.
- c. Circular No. 22/2017 dated 21.12.2017 has been issued clarifying the same procedure for removal of goods by artists and supply of such goods by artists from galleries.
- d. While the law only provides for movement in general, a corollary can be, that a delivery challan may be for movement-outward or / and movement-inward.
- e. A delivery challan would also be required to be prepared in triplicate, as applicable in case of tax invoices for goods (explained supra).

- f. The Rules also specifies the nature of other documents to be carried along with the goods under transportation. Please note that this list is illustrative and not exhaustive.

Nature of supply	Mandatory documents	Particulars to be contained in the document
(1) Where tax invoice could not be issued at the time of removal of goods for supply; (2) Supply of liquid gas where the quantity at the time of removal from the place of business of the supplier is not known; (3) Transportation of goods for job work; (4) Transportation of goods for reasons other than by way of supply; or (5) Such other supplies notified by the Board	1. The consignor to issue a delivery challan 2. Serially numbered Delivery challan to be issued in lieu of invoice at the time of removal of goods for transportation	(i) Date and number of the delivery challan, (ii) Name, address and GSTIN of the consignor, if registered, (iii) Name, address and GSTIN or UIN of the consignee, if registered, (iv) HSN code and description of goods, (v) Quantity (provisional, where the exact quantity being supplied is not known), (vi) Taxable value, (vii) Tax rate and tax amount – CGST, SGST/ UTGST, IGST or cess, where the transportation is for supply to the consignee, (viii) Place of supply, in case of inter-State movement, and (ix) Signature.

H. Important note: The person-in-charge of the conveyance shall carry a copy of the **tax invoice** or the **bill of supply** or **tax invoice cum bill of supply**, as explained in the preceding paragraphs, in a case where such person is not required to carry an e-way bill.

I. Special cases

- a. **Continuous supply of goods:** In case of a continuous supply of goods as defined in Section 2(32), the tax invoice is required to be issued:
- when the statement or a running-claim is issued; or
 - when payment is received.

Section 2(32) “continuous supply of goods” means a supply of goods which is provided, or agreed to be provided, continuously or on recurrent basis, under a contract, whether or not by means of a wire, cable, pipeline or other conduit, and

for which the supplier invoices the recipient on a regular or periodic basis and includes supply of such goods as the Government may, subject to such conditions, as it may, by notification, specify;

- b. **Continuous supply of services:** In case of a continuous supply of services as defined in Section 2(33) of the Act, a tax invoice is required to be issued as follows:
- (i) When payment date is **ascertainable** as per the contract:
 - o On or before the due date for payment.
 - (ii) When payment date is **not ascertainable** from the contract:
 - o On or before the time when the supplier of services receives the payment.
 - (iii) When payment is **linked to completion of an event:**
 - o On or before the date of completion of the event.

2(33) "continuous supply of services" means a supply of services which is provided, or agreed to be provided, continuously or on recurrent basis, under a contract, for a period exceeding three months with periodic payment obligations and includes supply of such services as the Government may, subject to such condition as it may, by notification, specify.

- c. **Goods sent on approval:** Where goods are sent on approval basis, an invoice would not be required at the time of removal of goods, and shall be issued only at the time of receipt of approval from the recipient. However, if the goods so dispatched have neither been accepted nor been returned within 6 months from the date of their removal, the tax invoice is required to be issued on the date immediately succeeding the date on which the 6-month period expires.
- d. **Goods sent on SKD / CKD conditions/batches/lots:** Where the goods are being transported in a semi knocked down (SKD) or completely knocked down (CKD) conditions or in batches or lots, the supplier must first issue the complete invoice before the first consignment is moved, and must also issue a copy along with every consignment. All other consignments must be accompanied by a delivery challan in terms of Rule 55 of the CGST Rules, 2017 along with a certified copy of the invoice. It is imperative to note that the original invoice must accompany the last consignment.
- e. **Cessation of service:** On cessation of a contract for supply of services, a tax invoice is required to be issued to the extent of supply effected upto the point of cessation, and due tax shall be remitted thereon.
- f. **Bill-to-ship-to transactions:** Where the place of supply is deemed to be the principal place of business **of the person on whose direction** the goods are dispatched to another person (as specified in Section 10(1)(b) of the IGST Act, 2017), the transaction would have 2 supplies. While one supply would be from the supplier to the person to whom the invoice is addressed, another supply would be deemed to be effected by the said addressee to the person who receives the goods. In such a case, the person may

consider the date of making available of the goods to the ultimate recipient, as the date on which the tax invoice is liable to be issued by him.

- g. **Goods sent to jobworker for the purpose of job work:** Where inputs or capital goods have been sent to the job worker for the purposes of jobwork, and have neither been returned nor been directly dispatched for supply from the place of the jobworker within the timelines specified in Section 19, it shall be deemed that such goods have been supplied by the Principal to the jobworker as on the date of dispatch of such goods to the jobworker (or the date of receipt of goods by the jobworker where the goods were sent to the jobworker's premises without being first received at the place of business of the Principal).

Special issues concerning Goods sent for Job work:

Goods sent to a job worker for the purpose of job work is a supply liable to tax under GST. However, as per Section 143 of the CGST Act, the principal may choose to send goods for job work without payment of tax subject to fulfillment of certain conditions. The documents that needs to be issued for movement of goods between the principal and the job worker are as follows:

1. Good sent for job work on payment of tax – The principal shall issue a tax invoice for goods sent for job work. The job worker, if registered, shall return the goods by raising another tax invoice. In case of receipt of goods after job work from an unregistered job worker, the principal will be required to raise an invoice as per Section 9(4) of the CGST Act (which is exempted till 30th September, 2019, vide notification no 8/2017-Central Tax (rate) dated 28.06.2017 amended time to time, however the said notification is rescinded by notification no 1/2019-Central Tax (Rate) dated 29-01-2019 wef 01.02.2019). After amendment of section 9(4) The Government may, on the recommendations of the Council, by notification, specify a class of registered persons who shall, in respect of supply of specified categories of goods or services or both received from an unregistered supplier, pay the tax on reverse charge basis as the recipient of such supply of goods or services or both)
2. Goods sent for job work without payment of tax – Circular No.38/12/2018 dated 26th March, 2018 has clarified the following:
 - (a) **Where goods are sent by principal to only one job worker:** The principal shall prepare in triplicate, the challan in terms of Rule 45 read with Rule 55 of the CGST Rules, for sending the goods to a job worker. Two copies of the challan may be sent to the job worker along with the goods. The job worker should send one copy of the said challan along with the goods, while returning them to the principal.
 - (b) **Where goods are sent from one job worker to another job worker:** In such cases, the goods may move under the cover of a challan issued either by the principal or the job worker. Alternatively, the challan issued by the principal

may be endorsed by the job worker sending the goods to another job worker, indicating therein the quantity and description of goods being sent. The same process may be repeated for subsequent movement of the goods to other job workers.

- (c) **Where the goods are sent directly by the supplier to the job worker:** In this case, the goods may move from the place of business of the supplier to the place of business/premises of the job worker with a copy of the invoice issued by the supplier in the name of the buyer (i.e. the principal) wherein the job worker's name and address should also be mentioned as the consignee, in terms of Rule 46(o) of the CGST Rules. The principal shall issue the challan under Rule 45 of the CGST Rules and send the same to the job worker directly in terms of para (a) above. In case of import of goods by the principal which are then supplied directly from the customs station of import, the goods may move from the customs station of import to the place of business/premises of the job worker with a copy of the Bill of Entry and the principal shall issue the challan under rule 45 of the CGST Rules and send the same to the job worker directly.
- (d) **Where goods are returned in piecemeal by the job worker:** In case the goods after carrying out the job work, are sent in piecemeal quantities by a job worker to another job worker or to the principal, the challan issued originally by the principal cannot be endorsed and a fresh challan is required to be issued by the job worker.

31.3 Comparative review

Under the erstwhile indirect tax laws, depending upon the taxable event, as to whether it is manufacture or sale or service, excise invoices or tax invoices are raised.

Under service tax regime, a time limit to issue a tax invoice is prescribed having regard to date of completion of such taxable service or receipt of any payment towards the value of such taxable service, whichever is earlier.

The provision to issue revised invoice (from the effective date of registration to the date of issuance of certificate) was not available earlier. This document would be useful for claiming tax credit for supply of goods/services during this period.

Under erstwhile law, invoices or bills of sale etc. can be issued inclusive of tax in certain cases whereas it is mandatory to indicate the amount of tax charged on every transaction in the GST regime.

31.4 Issues and Concerns

1. The value of supply and the amount of GST applicable thereon is required to be reflected separately in the tax invoice, in terms of Rule 46. However, a supplier is also permitted to effect supplies for an inclusive value – such as in case of travel agents paying tax on margins. In such cases, the supplier will be required to disclose their margins to the recipient, by virtue of this requirement.

2. Rule 46 of the CGST Rules, 2017 does not specifically provide as to how the details of tax must be reflected in cases of zero-rated supplies. Therefore, where a zero-rated supply has been effected on payment of IGST, the details thereof may be reflected separately on the face of the invoice, by providing a declaration to the effect that the same is not charged to the recipient of supply, given that disclosure of tax details is mandatory. In other cases, the applicable rate of tax can be stated, whereas the tax amount can be shown as '0'.
3. The Law does not specifically provide the manner in which the details of HSN, quantity, etc. must be reflected in cases of composite supply or mixed supply. However, given that Section 8 regards all composite supplies as the supply of principal supply alone, only those details pertaining to the principal supply must be reflected, while quoting the taxable value applicable to the composite supply as a whole. Whereas, in case of mixed supplies, the supply attracting the highest rate of tax ought to be reflected – what if both the supplies attract the same rate of tax?
4. While the GST law provides for a supplier to issue a revised tax invoice in respect of supplies made during the time period from the date of application of registration to the date of obtaining the registration, there are no similar provisions found for issuance of revised tax invoice to mention the GSTIN of the recipient, wherein a supply has been effected to a taxable person who has applied for registration, and receives such registration after the tax invoice has been issued by the supplier. Therefore, the recipient of supply may not be entitled to the credits on such inward supplies, unless the tax invoice is cancelled and reissued during the same tax period.
5. Given that all incidental expenses are required to be included in the value of supply, and the value of supply is determined for each of the goods and / services separately, even where all such goods and / or services are included in the same tax invoice, the incidental expenses (say freight, packing, etc.) will be required to be split up as attributable to each supply, separately. This would be a tedious task, and would be practically difficult to reflect it on the face of the invoice. To ensure that no tax is underpaid, the suppliers can adopt a reasonable basis to identify the most suitable rate of tax applicable on the incidental charges, by considering the contents of the invoice.
6. Where an advance has been received and the supplier is unable to determine the nature of tax, the law provides a deeming fiction to treat such supply as an inter-State supply. This provision would however, require a relook, considering that the place of supply is a must, for the purpose of reporting the transaction as an inter-State supply. Further, the law does not provide for closing the loop, as and when the rate of tax or the nature of tax have been ascertained. It appears that the only solution is to issue a refund voucher and reverse the effect of issue of the earlier receipt voucher, and thereafter, issue a tax invoice (where the supply has been effected), or issue a fresh receipt voucher with the correct details (where the supply is yet to be effected).
7. While Rule 54(1A) provides the form in which credits can be distributed by a registered person to its own ISD in the same State, no corresponding provision has been made

under the law which specifies that a registered person is entitled to issue an invoice to another registered person (whether ISD / any other person) where there is no underlying taxable supply. However, by virtue of this sub-rule which has been inserted, the intent of the law can be safely inferred that there is no such requirement and the registered persons may make use of this provision to furnish the details of common services to the ISD for the purpose of distribution.

31.5 FAQs

- Q1. Can tax invoice be raised for advance payments received for goods or services?
Ans. No, tax invoice is to be raised for advance payments received for goods or services. The recipient of payment would be required to issue a receipt voucher for receipt of payment in advance.
- Q2. Is it mandatory to mention the details of tax amount charged in the invoice?
Ans. Yes, the tax invoice should mandatorily mention the details of tax amount charged in the invoice.
- Q3. Is it possible to take input tax credit based on the 'bill of supply'?
Ans. No, it is not possible to take input tax credit based on the bill of supply.
- Q4. Can a revised invoice be issued for taxable supplies?
Ans. Yes, the registered taxable person can issue revised invoice. Every registered person who has been granted registration with effect from a date earlier than the date of issuance of certificate of registration to him, may issue revised tax invoices in respect of taxable supplies effected during the period starting from the effective date of registration till the date of issuance of certificate of registration.

Provided that the registered person may issue a consolidated revised tax invoice in respect of all taxable supplies made to a recipient who is not registered under the Act during such period

Statutory Provisions

32. Prohibition of unauthorised collection of tax

- (1) *A person who is not a registered person shall not collect in respect of any supply of goods or services or both any amount by way of tax under this Act.*
- (2) *No registered person shall collect tax except in accordance with the provisions of this Act or the rules made thereunder.*

32.1 Analysis

Collection of tax is not a statutory right but a contractual obligation. The person collecting taxes, acts as an agent of the Government. As such, no recipient is obliged to reimburse the supplier taxes due on the supply. At the same time, every taxable person (in case of forward charge) remains liable to deposit the applicable tax to the Government.

This provision casts an obligation on each – unregistered person and registered person with regard to collection of tax on supply:

- unregistered person is not to collect tax or any sum 'by way of' tax; and
- registered person is to collect tax only in the manner prescribed

It is important to differentiate between the restriction placed by this provision and the contractual route necessary to recoup tax by the supplier. Only tax that is collected as 'CGST' or 'IGST' or 'SGST-UTGST' is to be paid to the Government. Any other loss recoupment of input tax credit 'foregone or forfeited' does not fall within this restriction.

Statutory Provisions

33. Amount of tax to be indicated in tax invoice and other documents.

Notwithstanding anything contained in this Act or any other law for the time being in force, where any supply is made for a consideration, every person who is liable to pay tax for such supply shall prominently indicate in all documents relating to assessment, tax invoice and other like documents, the amount of tax which shall form part of the price at which such supply is made.

33.1 Analysis

With the non-obstante clause, this provision secures preference over any other provision to the contrary whether in this Act or elsewhere. It states that all documents need to carry these details and that the tax would form part of the price of supply.

This provision therefore holds the price charged to be the 'cum tax' price of the supply. Tax included in the price is that *actually assessed* on the supply.

It means that if the supply price is ₹1000/- which is inclusive of tax then every document must state that "the price of ₹1000 includes – say IGST of ₹180/- or alternatively say supply price is ₹820 and IGST ₹180 total ₹1000.

The GST law presupposes the fact that the tax, even, if not charged is deemed to have been passed on to the recipient unless proved contrary.

Statutory Provisions

34. Credit and debit notes

(1) **Where one or more tax invoices have¹ been issued for supply of any goods or services or both and the taxable value or tax charged in that tax invoice is found to**

¹ Substituted *vide* the Central Goods and Services Tax Amendment Act, 2018 w.e.f. 01.02.2019

exceed the taxable value or tax payable in respect of such supply, or where the goods supplied are returned by the recipient, or where goods or services or both supplied are found to be deficient, the registered person, who has supplied such goods or services or both, may issue to the recipient **one or more credit notes for supplies made in a financial year**² containing such particulars as may be prescribed.

- (2) Any registered person who issues a credit note in relation to a supply of goods or services or both shall declare the details of such credit note in the return for the month during which such credit note has been issued but not later than September following the end of the financial year in which such supply was made, or the date of furnishing of the relevant annual return, whichever is earlier, and the tax liability shall be adjusted in such manner as may be prescribed:

Provided that no reduction in output tax liability of the supplier shall be permitted, if the incidence of tax and interest on such supply has been passed on to any other person.

- (3) **Where one or more tax invoices have**³ been issued for supply of any goods or services or both and the taxable value or tax charged in that tax invoice is found to be less than the taxable value or tax payable in respect of such supply, the registered person, who has supplied such goods or services or both, shall issue to the recipient **one or more debit notes for supplies made in a financial year**⁴ containing such particulars as may be prescribed.

- (4) Any registered person who issues a debit note in relation to a supply of goods or services or both shall declare the details of such debit note in the return for the month during which such debit note has been issued and the tax liability shall be adjusted such manner as may be prescribed.

Explanation. – For the purposes of this Act, the expression “debit note” shall include a supplementary invoice.

Relevant circulars, notifications, clarifications issued by Government:

Annexure to Notification No. 11/2017-Central Tax (Rate) dt.28.06.2017 for scheme of classification of services

Notification 12/2017 – Central Tax dated 28.06.2017 regarding disclosure of HSN in the tax invoice

Notification 45/2017 – Central Tax dated 13.10.2017 Regarding issue of consolidated tax invoice

Notification No. 38/2017 – Central Tax (Rate) dated 13.10.2017 read with Notification No.

² Substituted *vide* the Central Goods and Services Tax Amendment Act, 2018 w.e.f. 01.02.2019

³ Substituted *vide* the Central Goods and Services Tax Amendment Act, 2018 w.e.f. 01.02.2019

⁴ Substituted *vide* the Central Goods and Services Tax Amendment Act, 2018 w.e.f. 1.02.2019

10/2018 –Central Tax (Rate) dated 23.03.2018; Notification No. 12/2018 –Central Tax (Rate) dated 29.06.2018 and Notification No. 22/2018 –Central Tax (Rate) dated 6.08.2018 for exemption of tax payable under Section 9(4) on reverse charge basis. Further, Notification No. 01/2019-Central Tax (Rate) dt. 29-01-2019 which rescinds No. 8/2017-Central Tax (Rate), dated the 28th June, 2017, in view of bringing into effect the amendments (regarding RCM on supplies by unregistered persons) in the GST Acts.

Circular 10/2017 dated 18.10.2017 for clarification where the goods are moved within the state or from the State of registration to another State for supply on approval basis

Circular 38/2018 dated 26.03.2018 regarding issued related to job work

Chapter Fifteen and Sixteen of the compilation of the GST Flyers as issued by the CBIC can be referred to for a gist of the statutory provisions, titled 'Credit Note in GST' and 'Debit Note in GST', respectively.

Circular 72/46/2018 dated 26.10.18 for clarification of procedure in respect of return of time expired drugs or medicine.

Related provisions of the Statute

Section or Rule	Description
Section 2(37)	Definition of Credit note
Section 2(38)	Definition of Debit note
Rule 53	Revised tax invoice and credit or debit notes
Section 15	Value of taxable supply
Section 31	Tax invoice
Section 74	Determination of tax not paid or short paid or erroneously refunded or input tax credit wrongly availed or utilised by reason of fraud or any wilful misstatement or suppression of facts.
Section 129	Detention, seizure and release of goods and conveyances in transit.
Section 130	Confiscation of goods or conveyances and levy of penalty.

34.1 Introduction

To begin with, one must fully unlearn the practices under the erstwhile law in order to clearly understand the concepts of credit note and debit note under the GST Law. A credit note or a debit note, for the purpose of the GST Law, can be issued by the registered person who has issued a tax invoice, i.e., the supplier. **Any such document, by whatever name called, when issued by the recipient to the registered supplier, is not a document recognized under the GST Law.**

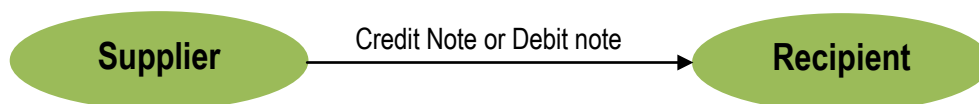

34.2 Analysis

- (i) Credit note and debit note cause some hardship to quickly understand – who owes whom. Credit note is issued when the issuer 'OWES' money to someone, that is, it is issued by the person who owes money. Debit note is issued when any money is 'OWED' to the issuer, that is, it is again issued by the person who is the receiver of money.
- a. When a cash discount is allowed at the time of collecting payment from a customer in terms of an agreement entered into prior to the supply, then the supplier would issue a credit note to the customer to the extent of such cash discount, to declare that he 'OWES' money. Then, the original amount due MINUS the credit note is the revised value of supply that the customer pays the supplier. To this extent the GST thereon would also stand reduced, subject to conditions which have been discussed in the subsequent paragraphs.
 - b. Now, if the supplier charges a penalty for delayed payment of consideration, the supplier would issue a debit note for the amount of penalty, to the customer to declare that money is 'OWED' to the supplier. Then, the original amount due PLUS the debit note is the revised value of supply, that the customer pays the supplier. To this extent the GST thereon would also stand increased.
- (ii) The conditions applicable on an issue of credit note are listed below:
- a. The supplier issues the credit note in respect of a tax invoice which has been issued by him earlier;
 - b. The credit note cannot be issued at any time after either of the following 2 events ("due date for credit note"):
 1. Annual return has been filed for the FY in which the original tax invoice was issued; or
 2. September of the FY immediately succeeding the FY in which the original tax invoice was issued (i.e., for a tax invoice issued in April 2018, as well as a tax invoice issued in March 2019, the relevant credit notes cannot be issued after September 2019);
 - c. The credit note so issued must be declared in the returns for the month in which they are issued, by the supplier and also the recipient, and latest by the due date for credit note as specified above.
 - d. The recipient, on declaring the same, must claim a reduction in his input tax credit if the same had been availed against the original tax invoice;
 - e. A credit note cannot be issued if the incidence of tax and interest on such supply has been passed by him to any other person;

- f. Every credit note must be linked to specific original tax invoice(s);
 - g. In case of a credit note issued for a discount, the discount must be provided in terms of an agreement entered into before or at the time of supply, as provided in Section 15(2) of the Act.
 - h. The GST Law provides an exhaustive list of situations under which the registered supplier is entitled to issue a credit note says, 'I OWE' and issues credit note:
 - 1. Actual value of supply is lower than that stated in the original tax invoice;
 - 2. Tax charged in the original tax invoice is higher than that applicable on the supply;
 - 3. Goods supplied are returned by the recipient;
 - 4. Goods or services supplied are deficient.
 - i. The credit note contains all the applicable particulars as specified in **Rule 53** of the CGST Rules, 2017.
- (iii) The GST Law mandates that a registered supplier shall be required to issue a debit note under the following circumstances:
- a. Actual value of supply is higher than that stated in the original tax invoice;
 - b. Tax charged in the original tax invoice is lower than that applicable on the supply;
 - c. The debit note needs to be linked to the original tax invoice(s);
 - d. The debit note contains all the applicable particulars as specified in **Rule 53** of the CGST Rules, 2017;
 - e. A debit note issued under Section 74, 129 or 130 would not entitle the recipient to avail credit in respect thereof, and the supplier shall specify prominently, on such debit note the words "INPUT TAX CREDIT NOT ADMISSIBLE";
 - f. It may also be noted that no time limit has been prescribed for issuing debit notes. Meaning, a debit note may be raised and uploaded subsequently, with no restriction as to the time period for doing so.
- (iv) A consolidated credit note / debit note cannot be issued for an aggregate value attributable to more than one tax invoice. Additionally, the date and serial number of the original tax invoice is mandatory while reflecting document-level details of credit notes / debit notes in the returns. However, the Central Goods and Services Tax (Amendment) Act, 2018 has amended the provisions, with effect from 01.02.2019, to enable the supplier to issue either one or more credit notes or debit notes against multiple supplies effected in a financial year.
- (v) Except in the circumstances specified, credit note or debit note is not permitted to be issued merely because a financial adjustment is required to be made in respect of the

receivable or payable. Please note that any credit note / debit note not issued in terms of Section 34 would not be a valid document under the GST Law. For instance, if a credit note has been issued in respect of goods returned after the due date for credit note, a credit note may be issued by the supplier for reduction in the amount payable by the recipient. However, he cannot claim a reduction in tax liability. On the other hand, the recipient of tax may be imposed to reverse the input tax credit that had been availed thereon. This position of law is also clarified vide Circular 72/46/2018 dated 26.10.18 wherein it is clarified for claiming the reduction in output tax liability in case of return of goods (whether the goods have been expired or otherwise), the credit note should have been issued within the time limit specified under Section 34(2). It is further clarified that any credit notes issued after expiry of time limit specified under Section 34(2), there is no requirement to declare such credit note on the common portal by the supplier as tax liability cannot be adjusted in such case.

- (vi) Please review the circumstance for issuing credit note. As per circular 72, there is no time limit to issue credit note but only for effecting 'tax adjustment'. Credit note where tax adjustment is not involved need not even be filed on the portal as per this circular. Further, on review of table 5E and 5J of GSTR 9C, it is evident that such credit notes will suffer tax without any relief to recipient by way of tax adjustment.

34.2 Comparative review

- (i) Rule 9 of CENVAT Credit Rules, 2004 gives details of the documents and accounts which need to be mandatorily adhered to in order to avail the benefit of CENVAT Credit.
- (ii) As per the Rule, CENVAT Credit can be availed based on: -
 - (a) An invoice
 - (b) Supplementary invoice
- (iii) In the context of excise laws, though credit notes may be issued in situations where taxable value is reduced, typically, no adjustment is made for excise valuation purpose (except when the assessment is provisional). Instead of debit notes for increase in taxable value/tax, supplementary invoices are issued (this is a valid document for taking CENVAT credit). There is no time limit for issuance of credit/debit notes (supplementary invoice).
- (iv) In the context of service tax laws, credit notes may be issued in situations where taxable value is reduced. Adjustment of excess tax paid is permissible in specified situations. Instead of debit notes for increase in taxable value/tax, supplementary invoices are issued (this is a valid document for taking CENVAT credit). While the law stipulates the time limit for issuance of credit note (viz., end of September following the financial year in which the supply was effected or filing of annual return whichever is earlier), there is no time limit for that has been specified for issuance of debit notes (supplementary invoice).

However, credit availed on tax paid on supplementary invoices could be disputed in circumstances where additional tax was payable by reason of fraud, collusion, wilful mis-statement, suppression of facts, contravention of any of the provisions with intent to evade duty/taxes.

- (v) Most State VAT laws have provisions relating to issue of Credit or Debit notes for difference in value of supply and tax. Time period (usually 6 months from the date of sale) is prescribed for issuance of credit/debit notes for adjustment against taxable value. Some States provide that if the credit has already passed on in the original invoice, the tax component shall not be adjusted by issuance of credit note (this is because the buyer would have taken credit in such cases and the credit is left undisturbed).

34.3 Issues and concerns

1. It is a common practice of trade and industry to issue volume discounts / turnover discounts, at the end of a certain period, say a financial year. Clearly, such discounts cannot be provided at the time of supply to reflect the same on the tax invoice. On the other hand, although the discount is a post-supply discount which is established in terms of an agreement entered into before or at the time of supply, the discount cannot be specifically linked to any one invoice. By virtue of this drawback, discounts of such nature would not permit the supplier to claim a reduction in his output tax liability. However, to redress this issue, the Central Goods and Services Tax (Amendment) Act, 2018 provides the issuance of one or more credit notes or debit notes against multiple supplies in a financial year.
2. The GST Law has not provided a scenario whereby a supplier forgoes a certain part of consideration, in full and final settlement of the dues from a recipient, even where such a reduction can be identified with a specific invoice. In other words, the supplier would be required to issue a tax invoice for the agreed value and discharge tax on the whole value, while he collects only a part payment thereof from the recipient and would not be permitted to reduce his output tax liability, since the reduction is not on account of a deficiency in service / goods. Given this anomaly, a reasonable inference can be drawn to say that the reduction is on account of reduction in the value of supply, being the reduction in the amount of consideration received, wherein "price is **in fact** the sole consideration". The tax department in such a situation could – (a) Resort to reverse the input tax credit on a pro-rata basis **and** (b) subject the value of the said credit note to output tax. It is also important to note that if the tax department resorts to such action, the recipient too would not be in a position avail any credits of such tax paid at a later point in time. It will not be out of place to mention that the recipient, in any event, will be subject to reversal of input tax credit to the extent he does not effect payment to the supplier against the original invoice by virtue of the provisions of Section 16(2) of the CGST Act, 2017 however, experts believe that non-payment of invoice amount is not the same as accounting-adjustment of invoice amount by netting-off with financial or other credit notes.

34.3 FAQs

- Q1. Can credit notes/debit notes be raised without raising an appropriate tax invoice?
- Ans. No, credit notes/debit notes have to be raised with reference to specific invoice and not otherwise to get the benefit of tax adjustment.
- Q2. Is it mandatory to show the details of credit/debit notes in the periodic returns?
- Ans. Yes, the details of debit note and credit note is required to be mentioned in periodic returns. If not shown, it is not considered for adjustment of tax liability.
- Q3. Are there any situations where credit note cannot be issued?
- Ans. Amongst others, a credit note cannot be issued if the incidence of tax and interest on such supply has been passed by tax payer to any other person.
- Q4. Can a supplier who has wrongly charged tax at 18% instead of 12% subsequently issue a credit note only to the extent of the excess tax charged?
- Ans. Yes, a credit note can be issued only towards the excess tax charged in an invoice.

34.4 MCQs

- Q1. What is the last date by which you need to issue debit/credit note?
- (a) On or before Sept 30, following the end of financial year
 - (b) The date of filing of the relevant annual return
 - (c) Earlier of the two dates mentioned in (a) and (b) above
 - (d) None of the above
- Ans. (c) Earlier of the two dates mentioned in (a) and (b) above
- Q2. What is the last date by which you need to issue Debit Note?
- (a) On or before Sept 30, following the end of financial year
 - (b) The date of filing of the relevant annual return
 - (c) Earlier of the two dates mentioned in (a) and (b) above
 - (d) None of the above
- Ans. (d) None of the above

Chapter 9

Accounts and Records

Sections	Rules
35. Accounts and other records	56. Maintenance of accounts by registered persons
36. Period of retention of accounts	57. Generation and maintenance of electronic records
	58. Records to be maintained by owner or operator of godown or warehouse and transporters.

Statutory Provisions- Effective from 1st July, 2017 to 31st January, 2019

<p>35. Accounts and other records</p> <p>(1) <i>Every registered person shall keep and maintain, at his principal place of business, as mentioned in the certificate of registration, a true and correct account of—</i></p> <p style="margin-left: 20px;">(a) <i>production or manufacture of goods;</i></p> <p style="margin-left: 20px;">(b) <i>inward and outward supply of goods or services or both;</i></p> <p style="margin-left: 20px;">(c) <i>stock of goods;</i></p> <p style="margin-left: 20px;">(d) <i>input tax credit availed;</i></p> <p style="margin-left: 20px;">(e) <i>output tax payable and paid; and</i></p> <p style="margin-left: 20px;">(f) <i>such other particulars as may be prescribed:</i></p> <p><i>Provided that where more than one place of business is specified in the certificate of registration, the accounts relating to each place of business shall be kept at such places of business:</i></p> <p><i>Provided further that the registered person may keep and maintain such accounts and other particulars in electronic form in such manner as may be prescribed.</i></p> <p>(2) <i>Every owner or operator of warehouse or godown or any other place used for storage of goods and every transporter, irrespective of whether he is a registered person or not, shall maintain records of the consigner, consignee and other relevant details of the goods in such manner as may be prescribed.</i></p> <p>(3) <i>The Commissioner may notify a class of taxable persons to maintain additional accounts or documents for such purpose as may be specified therein.</i></p> <p>(4) <i>Where the Commissioner considers that any class of taxable person is not in a position to keep and maintain accounts in accordance with the provisions of this</i></p>
--

section, he may, for reasons to be recorded in writing, permit such class of taxable persons to maintain accounts in such manner as may be prescribed.

- (5) *Every registered person whose turnover during a financial year exceeds the prescribed limit shall get his accounts audited by a chartered accountant or a cost accountant Accounts and shall submit a copy of the audited annual accounts, the reconciliation statement under sub-section (2) of section 44 and such other documents in such form and manner as may be prescribed.*
- (6) *Subject to the provisions of clause (h) of sub-section (5) of section 17, where the registered person fails to account for the goods or services or both in accordance with the provisions of sub-section (1), the proper officer shall determine the amount of tax payable on the goods or services or both that are not accounted for, as if such goods or services or both had been supplied by such person and the provisions of section 73 or section 74, as the case may be, shall, mutatis mutandis, apply for determination of such tax.*

Statutory Provisions- Effective from 1st February 2019 vide The Central Goods & Services Tax Amendment Act,2018

35. Accounts and other records

- (1) *Every registered person shall keep and maintain, at his principal place of business, as mentioned in the certificate of registration, a true and correct account of—*
- (a) *production or manufacture of goods;*
 - (b) *inward and outward supply of goods or services or both;*
 - (c) *stock of goods;*
 - (d) *input tax credit availed;*
 - (e) *output tax payable and paid; and*
 - (f) *such other particulars as may be prescribed:*
- Provided that where more than one place of business is specified in the certificate of registration, the accounts relating to each place of business shall be kept at such places of business:*
- Provided further that the registered person may keep and maintain such accounts and other particulars in electronic form in such manner as may be prescribed.*
- (2) *Every owner or operator of warehouse or godown or any other place used for storage of goods and every transporter, irrespective of whether he is a registered person or not, shall maintain records of the consigner, consignee and other relevant details of the goods in such manner as may be prescribed.*
- (3) *The Commissioner may notify a class of taxable persons to maintain additional accounts or documents for such purpose as may be specified therein.*
- (4) *Where the Commissioner considers that any class of taxable person is not in a position to keep and maintain accounts in accordance with the provisions of this*

section, he may, for reasons to be recorded in writing, permit such class of taxable persons to maintain accounts in such manner as may be prescribed.

- (5) Every registered person whose turnover during a financial year exceeds the prescribed limit shall get his accounts audited by a chartered accountant or a cost accountant Accounts and shall submit a copy of the audited annual accounts, the reconciliation statement under sub-section (2) of section 44 and such other documents in such form and manner as may be prescribed.

Provided that nothing contained in this sub-section shall apply to any department of the Central Government or a State Government or a local authority, whose books of account are subject to audit by the Comptroller and Auditor-General of India or an auditor appointed for auditing the accounts of local authorities under any law for the time being in force.

- (6) Subject to the provisions of clause (h) of sub-section (5) of section 17, where the registered person fails to account for the goods or services or both in accordance with the provisions of sub-section (1), the proper officer shall determine the amount of tax payable on the goods or services or both that are not accounted for, as if such goods or services or both had been supplied by such person and the provisions of section 73 or section 74, as the case may be, shall, mutatis mutandis, apply for determination of such tax.

Extract of the CGST Rules, 2017

56. Maintenance of accounts by registered persons.

- (1) Every registered person shall keep and maintain, in addition to the particulars mentioned in sub-section (1) of section 35, a true and correct account of the goods or services imported or exported or of supplies attracting payment of tax on reverse charge along with the relevant documents, including invoices, bills of supply, delivery challans, credit notes, debit notes, receipt vouchers, payment vouchers and refund vouchers.
- (2) Every registered person, other than a person paying tax under section 10, shall maintain the accounts of stock in respect of goods received and supplied by him, and such accounts shall contain particulars of the opening balance, receipt, supply, goods lost, stolen, destroyed, written off or disposed of by way of gift or free sample and the balance of stock including raw materials, finished goods, scrap and wastage thereof.
- (3) Every registered person shall keep and maintain a separate account of advances received, paid and adjustments made thereto.
- (4) Every registered person, other than a person paying tax under section 10, shall keep and maintain an account, containing the details of tax payable (including tax payable in accordance with the provisions of sub-section (3) and sub-section (4) of section 9), tax collected and paid, input tax, input tax credit claimed, together with a register of

tax invoice, credit notes, debit notes, delivery challan issued or received during any tax period.

- (5) *Every registered person shall keep the particulars of -*
- (a) *names and complete addresses of suppliers from whom he has received the goods or services chargeable to tax under the Act;*
 - (b) *names and complete addresses of the persons to whom he has supplied goods or services, where required under the provisions of this Chapter;*
 - (c) *the complete address of the premises where goods are stored by him, including goods stored during transit along with the particulars of the stock stored therein.*
- (6) *If any taxable goods are found to be stored at any place(s) other than those declared under sub-rule (5) without the cover of any valid documents, the proper officer shall determine the amount of tax payable on such goods as if such goods have been supplied by the registered person.*
- (7) *Every registered person shall keep the books of account at the principal place of business and books of account relating to additional place of business mentioned in his certificate of registration and such books of account shall include any electronic form of data stored on any electronic device.*
- (8) *Any entry in registers, accounts and documents shall not be erased, effaced or overwritten, and all incorrect entries, otherwise than those of clerical nature, shall be scored out under attestation and thereafter the correct entry shall be recorded and where the registers and other documents are maintained electronically, a log of every entry edited or deleted shall be maintained.*
- (9) *Each volume of books of account maintained manually by the registered person shall be serially numbered.*
- (10) *Unless proved otherwise, if any documents, registers, or any books of account belonging to a registered person are found at any premises other than those mentioned in the certificate of registration, they shall be presumed to be maintained by the said registered person.*
- (11) *Every agent referred to in clause (5) of section 2 shall maintain accounts depicting the,-*
- (a) *particulars of authorisation received by him from each principal to receive or supply goods or services on behalf of such principal separately;*
 - (b) *particulars including description, value and quantity (wherever applicable) of goods or services received on behalf of every principal;*
 - (c) *particulars including description, value and quantity (wherever applicable) of goods or services supplied on behalf of every principal;*

- (d) *details of accounts furnished to every principal; and*
 - (e) *tax paid on receipts or on supply of goods or services effected on behalf of every principal.*
- (12) *Every registered person manufacturing goods shall maintain monthly production accounts showing quantitative details of raw materials or services used in the manufacture and quantitative details of the goods so manufactured including the waste and by products thereof.*
- (13) *Every registered person supplying services shall maintain the accounts showing quantitative details of goods used in the provision of services, details of input services utilised and the services supplied.*
- (14) *Every registered person executing works contract shall keep separate accounts for works contract showing -*
 - (a) *the names and addresses of the persons on whose behalf the works contract is executed;*
 - (b) *description, value and quantity (wherever applicable) of goods or services received for the execution of works contract;*
 - (c) *description, value and quantity (wherever applicable) of goods or services utilized in the execution of works contract;*
 - (d) *the details of payment received in respect of each works contract; and*
 - (e) *the names and addresses of suppliers from whom he received goods or services.*
- (15) *The records under the provisions of this Chapter may be maintained in electronic form and the record so maintained shall be authenticated by means of a digital signature.*
- (16) *Accounts maintained by the registered person together with all the invoices, bills of supply, credit and debit notes, and delivery challans relating to stocks, deliveries, inward supply and outward supply shall be preserved for the period as provided in section 36 and shall, where such accounts and documents are maintained manually, be kept at every related place of business mentioned in the certificate of registration and shall be accessible at every related place of business where such accounts and documents are maintained digitally.*
- (17) *Any person having custody over the goods in the capacity of a carrier or a clearing and forwarding agent for delivery or dispatch thereof to a recipient on behalf of any registered person shall maintain true and correct records in respect of such goods handled by him on behalf of such registered person and shall produce the details thereof as and when required by the proper officer.*
- (18) *Every registered person shall, on demand, produce the books of accounts which he is required to maintain under any law for the time being in force.*

57. Generation and maintenance of electronic records

- (1) *Proper electronic back-up of records shall be maintained and preserved in such manner that, in the event of destruction of such records due to accidents or natural causes, the information can be restored within a reasonable period of time.*
- (2) *The registered person maintaining electronic records shall produce, on demand, the relevant records or documents, duly authenticated by him, in hard copy or in any electronically readable format.*
- (3) *Where the accounts and records are stored electronically by any registered person, he shall, on demand, provide the details of such files, passwords of such files and explanation for codes used, where necessary, for access and any other information which is required for such access along with a sample copy in print form of the information stored in such files.*

58. Records to be maintained by owner or operator of godown or warehouse and transporters

- (1) *Every person required to maintain records and accounts in accordance with the provisions of sub-section (2) of section 35, if not already registered under the Act, shall submit the details regarding his business electronically on the common portal in FORM GST ENR-01, either directly or through a Facilitation Centre notified by the Commissioner and, upon validation of the details furnished, a unique enrolment number shall be generated and communicated to the said person.*
- (1A) *For the purposes of Chapter XVI of these rules, a transporter who is registered in more than one State or Union Territory having the same Permanent Account Number, he may apply for a unique common enrolment number by submitting the details in FORM GST ENR-02 using any one of his Goods and Services Tax Identification Numbers, and upon validation of the details furnished, a unique common enrolment number shall be generated and communicated to the said transporter:
*Provided that where the said transporter has obtained a unique common enrolment number, he shall not be eligible to use any of the Goods and Services Tax Identification Numbers for the purposes of the said Chapter XVI.**
- (2) *The person enrolled under sub-rule (1) as aforesaid in any other State or Union territory shall be deemed to be enrolled in the State or Union territory.*
- (3) *Every person who is enrolled under sub-rule (1) shall, where required, amend the details furnished in FORM GST ENR-01 electronically on the common portal either directly or through a Facilitation Centre notified by the Commissioner.*
- (4) *Subject to the provisions of rule 56,-*
 - (a) *any person engaged in the business of transporting goods shall maintain records of goods transported, delivered and goods stored in transit by him*

along with the Goods and Services Tax Identification Number of the registered consigner and consignee for each of his branches.

- (b) every owner or operator of a warehouse or godown shall maintain books of accounts with respect to the period for which particular goods remain in the warehouse, including the particulars relating to dispatch, movement, receipt and disposal of such goods.
- (5) The owner or the operator of the godown shall store the goods in such manner that they can be identified item-wise and owner-wise and shall facilitate any physical verification or inspection by the proper officer on demand.

Relevant circulars, notifications, clarifications issued by Government

1. Circular No. 23/23/2017 dated 21.12.2017 regarding maintenance of books of accounts for additional place of business by a principal or auctioneer for the purpose of auction of tea, coffee, rubber etc.;
2. Circular No. 38/12/2018 dated 26.03.2018 clarifying on issues related to job work;
3. Chapter Fourteen of the compilation of the GST Flyers as issued by the CBIT can be referred to for a gist of the statutory provisions, titled 'Accounts and Records in GST'.
4. Notification No 28/2018 dated 19.06.2018 regarding insertion of sub-rule (1A) in Rule 58.
5. Circular No. 47/21/2018-GST dated 08.06.2018 clarifying the manner in which the books of accounts are maintained at every place of business by the principal and auctioneer.
6. Circular No. 61/35/2018-GST dated 04.09.2018 clarifying the manner in which the books of accounts are maintained at every place of business by transporter and recipient where goods are storing in the godown of transporter.

Related provisions of the Statute

Section or Rule	Description
Section 2(94)	Definition of Registered Person
Section 2(85)	Definition of Place of business
Section 2(89)	Definition of Principal place of business
Section 36	Period of retention of accounts
Section 44	Annual return
Rule 80	Annual return

Rule 56	Maintenance of accounts by registered persons
Rule 57	Generation and maintenance of electronic records
Rule 58	Records to be maintained by owner or operator of godown or warehouse and transporters

35.1 Introduction

This Section mandates the upkeep and maintenance of records, at the place(s) of business, in electronic or other forms. Furnishing of an audited statement of accounts and reconciliation statement is also contemplated for persons having turnovers exceeding the prescribed limit. There is no relaxation provided to persons who have voluntarily obtained registration. This section read with relevant rules provides for the manner and method of maintenance of records of all kinds and classes of persons, as well.

35.2 Analysis

- (i) The importance of maintenance of books and records need no emphasis. It is presumed that all business entities would be aware of the nature of books and records to be maintained. However, it is important to note that the GST Law is a devil in details. It means that there is a lot of emphasis placed on primary and secondary books and records. There is no need to stress on the relevance or importance of maintenance of such records, since it is common in the digital world for businesses to maintain such books and records electronically. Having said that, one must bear in mind the importance of maintaining the primary book or record of entry that would have evidentiary value.
- (ii) This section emphasises “true and correct” account meaning – the concept of materiality is largely given the go-bye. Tax authorities would go by the actual records maintained and would not place much reliance of the concept of materiality.
- (iii) Every registered person is required to keep and maintain accounts and records in that reflect the true and correct account of the transactions effected. In other words, separate accounts shall be required to be maintained by a single person, in respect of each of the GSTINs operative during the year reflecting the following details:
 - Production / manufacture of goods;
 - Inward and outward supply of goods or services or both;
 - Stock records of goods;
 - Input tax credit availed output tax payable and paid; and
 - Such other particulars as may be prescribed in this behalf.
- (iv) The accounts are to be maintained at the principal place of business (as mentioned in the certificate of registration). In case of multiple places of business (as specified in the certificate of registration), the accounts relating to each place of business shall be kept

at the respective places of business concerned. Where records are maintained manually, all records pertaining to the operations at a place of business shall be maintained in such place of business.

- (v) The registered person has the option to keep and maintain accounts and other records in electronic form. In such a case, the records shall be authenticated by way of digital signature. Additionally, the GST Law mandates that a proper electronic back-up is maintained and preserved where accounts are maintained electronically, to restore information in the event of its destruction, within a reasonable period of time.
- (vi) It is important to note that in respect of quantitative information, the 'unit of measurement' must be such that the actual units used for procurement and supply can be determined or computed. For example, in case goods are procured in 'square meters' and they are supplied in 'square feet', the accounts for the stock of goods must be maintained in either sq.mt. or sq.ft., or a conversion-ratio must be applied so as to extract information in terms of one of the units. The translation losses, if any, may be written off – however, input tax credit to the extent of reduction would also require a reversal. In case of any increase, the value may be ignored, given that the increase does not result in additional pay-out to the supplier.
- (vii) The Commissioner is empowered to:
 - (a) Notify a class of taxable persons to maintain additional accounts or documents for specified purpose – *No notification has been issued in this regard as of date.*
 - (b) Permit a class of taxable persons to maintain the records in any other manner – If he believes that they are not in a position to keep and maintain accounts in accordance with this Section.
- (viii) There is no standalone Section that requires a registered person to get his accounts audited by a chartered accountant or a cost accountant. It is specified that every registered person whose turnover during a financials year exceeds prescribed limit shall get his accounts audited. Therefore, it is apparent that the audit under the provisions of the GST law should be undertaken for each registration viz., GSTIN-wise.
 - (a) While Rule 80(3) of the Rules speaks of the prescribed threshold limit at Rs. 2 Crore which is attributed to the 'aggregate turnover', the relevant section speaks of the turnover in the State / turnover attributable to a GSTIN. Therefore, if a registered person is liable to get his accounts audited under Section 35, all the registrations obtained under the same PAN will also be liable for such audit, regardless of the turnover in each State in which the other registrations have been obtained. For example if the aggregate turnover (PAN based) is at Rs.5 crores and the registered person is carrying on business in two different States having a turnover of Rs.4.75 crores and 0.25 crores respectively, the law mandates that audit is required to be carried out in both the States.

- (b) The registered person is required make the following submissions to the proper officer:
- (i) the annual return for the financial year;
 - (ii) a copy of the audited statement of accounts;
 - (iii) a reconciliation statement u/s 44(2), reconciling the value of supplies declared in the annual return with the audited annual financial statement.
 - (iv) Other particulars as may be prescribed.
 - (v) Note: No other documents have been prescribed in this regard as of date. The details that may be sought for, may be an extract of any of the records / documents which are required to be maintained under this Section.
- (c) The audit of the transactions undertaken under the GST regime will cover the entire gamut of transactions of a particular GSTIN. For instance, if the audit is undertaken for a registered person being an agent for supply of goods, it must be understood that the agent would be recording all the good received on behalf of the Principal as inward supply of goods, as also the goods dispatched on behalf of the Principal as outward supply of goods. On the other hand, the income / revenue that would be reflected in his books of account under any other statute would only be limited to the commission income. Accordingly, for the purpose of the GST Laws, the agent would be regarded as a person engaged in effecting outward supply of goods, and would therefore be required to maintain all the stock records that are to be maintained by a trader.
- (d) It shall be noted that the provisions relating to audit of books of accounts are amended vide Central Goods and Service Tax (Amendment) Act, 2018 wherein the *proviso* is inserted to Section 35(5) to extend exemption from audit of books of accounts to the Central Government, State Government, local authority whose books of accounts are subject to audit by the Comptroller and Auditor General of India or an auditor appointed for auditing the accounts of local authorities under any law for the time being in force.
- (ix) The following checks / approach may be adopted for the purpose of ensuring comprehensiveness in reporting:
- (a) Inward supplies: Every inward supply effected by a registered person shall be one of the following:
- ✓ Appear in the details for inward supplies (including the effect of debit / credit notes received) furnished in the returns, (including cases of exchange, barter, deemed supply such as agency transactions, etc.) while the details may be of:
 - (1) Eligible credits – including partly ineligible credits which are reversed to the extent ineligible;
 - (2) Ineligible credits.

- ✓ Appear as exempt / nil rated / non-taxable inward supplies; or
- ✓ Appear as inward supplies from composition suppliers; or
- ✓ Not reported for any of the following reasons:
 - (1) It is neither a supply of goods nor a supply of services (such as salary paid to employees); or
 - (2) It is an inward supply received from a registered supplier wherein the supplier is unaware of the fact that the supply is made to a registered person (i.e., where the supplier reports the transaction as part of summary details under B2C supplies in his GST returns) – e.g., food bills, etc.
 - (3) It is an accounting entry made in the books of account by virtue of a requirement under another statute – such as provision for accrued expenses, depreciation, bad debts written-off, debit / credit notes issued in the capacity of a recipient, etc.

Note: Every inward supply that is eligible for credits shall form part of detailed entries (invoice-level information) in Form GSTR-1 of any registered supplier, except in the case of inward supplies liable to tax on reverse charge basis.

- (b) Outward supplies: Every outward supply effected by the registered person would need to appear in the returns for outward supplies where:
- ✓ Every taxable outward supply that is effected to a registered person shall be reported at invoice level, including:
 - (1) Credit notes having a reduction in taxable value / tax, unless the same is time-barred under the GST Laws;
 - (2) Debit notes issued for increase in taxable value / tax;
 - (3) The value of expenses incurred by the recipient, although liable to be incurred by the registered person as a supplier, the value of incidental expenses such as delivery charges, etc. and any other amount liable to be included in the value of supply in terms of Section 15(2) of the CGST Act, 2017;
 - (4) The value determined under the valuation rules, where the price is not the sole consideration for the supply, or where the supply is made to a related person, is to be reckoned for these purposes;
 - (5) Transactions regarded as supply despite lacking consideration (i.e., activities specified under Schedule I);
 - ✓ Summary details to be reported in case of supply of exempted / nil-rated / non-taxable outward supplies, and supplies to unregistered persons.

- (x) It is clarified vide Circular No. 47/21/2018-GST dated 08.06.2018 that the persons involved in auction either as a principal or auctioneer shall declare warehouse or other places as additional place of business in case such places are meant for storage of goods. The principal and the auctioneer shall also maintain the books of accounts in terms of Section 35(1) at such places. However, it is clarified that the books of accounts may be maintained at the principal place of business in case of any difficulties faced in maintaining the books of accounts at such additional place of business upon intimating the jurisdictional officer in writing.
- (xi) It is also clarified vide Circular No. 61/35/2018-GST dated 04.09.2018 that in case of storing of goods in godown of transporter, then the transporter's godown has to be declared as an additional place of business by the recipient. The transporter and recipient shall maintain the books of account in terms of section 35 at such places. However, it is clarified that books of accounts in relation to goods stored at the transporter's godown (i.e., the recipient taxpayer's additional place of business) by the recipient taxpayer may be maintained by him at his principal place of business.
- (xii) Special attention is, in cases of requirement to reverse input tax credit availed, as provided under Section 16(2), Section 17(2) or Section 17(5)(h) – Where goods are lost, stolen, destroyed, written off, or disposed of as gifts or free samples, proportionate input tax credit should be reversed.
- (xiii) One needs to pay attention to the relevant Rules, wherein it is mandated that the details specified / prescribed ought to be captured while maintaining books and records viz., name, address, GSTIN, description, quantity value etc., as stipulate in section 31 needs to be captured. Special category of persons such as works contractors, lessors agents, auctioneers etc ought to maintain data / details in the manner specified.
- (xiv) It is important to note the import of Rule 56(6). It clearly specifies that taxable goods stored in an unregistered place of business without cover of valid documents would be subject to tax as if such goods have been supplied.
- (xv) Entries in books and records cannot be erased, effaced or overwritten. However, any such act needs to be attested in cases of manual maintenance of books and records while digital records would require a suitable log of such corrections to be maintained.
- (xvi) Rule 56(10) is presumptive in nature. Meaning any documents or books and records found in a place other than the registered persons' place of business, it would be presumed to be maintained by such registered person. All other consequences under the GST Laws would automatically follow.
- (xvii) The law mandates the following persons to maintain the records of the consigner, consignee and other relevant details of the goods, even if such persons are not registered under the Act:
- (a) A transporter of goods; and

- (b) Persons who own and operate, or persons who operate any warehouse, godown, etc. for storage of goods – the goods shall be stored in a manner in which they can be identified item-wise and owner-wise.

The provisions relating to enrolment of transporters are amended vide The Central Goods and Service Tax (Sixth Amendment) Rules, 2018 with effect from 19.06.2018 wherein it is specified that in case the transporter having place of business in more than one State or Union Territory and all such places of business are registered under the provisions of the GST law, shall obtain the unique common enrolment number. The application seeking unique common enrolment number shall be filed in Form GST ENR – 02. Such registered transporter shall enrol on the basis of GSTIN of any State of his choice. It is also provided that such enrolment number shall be used by the transporter for generating the e-way bills and for undertaking the transport of goods.

35.3 Comparative Review

Maintenance of records has been prescribed under the Central Excise, Service Tax and State VAT laws. The provisions are briefly discussed below:

Service tax records

- Rule 5(1) of Service Tax Rules, 1994 provides that the records including computerised data as maintained by the assessee in accordance with the various laws in force from time to time shall be acceptable.
- Rule 5(2) provides that every assessee, at the time of filing of his first return shall furnish to the department, a list in duplicate of: -
 - (i) All the records maintained by the assessee for accounting of transactions in regard to: -
 - (a) Providing of any service;
 - (b) Receipt or procurement of input service and payment of such input service;
 - (c) Receipt, purchase, manufacture, storage, sale, or delivery, regarding input or capital goods; and
 - (d) Other activities such as manufacture and sale of goods if any.
 - (ii) All other financial records maintained by him in the normal course of business.
- Rules 5(4) and (5) provide for preservation of records in electronic form.

Central Excise Records

- Rule 10 of the Central Excise Rules, 2002 obligates the maintenance of "Daily Stock Account" indicating the particulars regarding description of the goods produced or manufactured, opening balance, quantity produced or manufactured, inventory of

goods, quantity removed, assessable value, the amount of duty payable and particulars regarding amount of duty paid.

- Chapter 6 of the Central Excise Manual obligates every assessee to furnish to the Range Officer, a list in duplicate, of all the records prepared or maintained by him for accounting of transactions in regard to receipt, purchase, manufacture, storage, sales or delivery of the goods including inputs and capital goods

Cenvat Records

Rule 9 of Cenvat Credit Rules, 2004 provides for maintenance of various records for availment and utilization of CENVAT credit on inputs, input services and capital goods.

VAT Records

VAT laws of most States obligate every assessee to keep and maintain an up-to-date, true and correct account showing full and complete particulars of his business and such other records as may be prescribed. There is an option to maintain those records at other place or places as he may notify to the registering authority in advance.

Audit of Accounts and Reconciliation Statement

Under the Central excise and service tax laws, there is no requirement for audit of accounts and furnishing reconciliation statement by a Chartered Accountant and Cost accountant. Many State VAT laws stipulate audit of records by a Chartered Accountant and filing of VAT audit reports. Threshold limits are prescribed for such audits.

Reconciliations between the tax records and audited statement of accounts is generally sought for at the time of assessment, audit or investigation by the revenue authorities. There is no statutory requirement to furnish such reconciliation statements under the erstwhile laws although it is carried out during audit / Certification of records.

35.4 Issues and concerns

1. **Multiple books of account for the same entity:** While the accounts of a person are required to be maintained for the entire business concern (i.e., PAN-wise), the GST law requires separate book-keeping for every GSTIN. This will mean that every account maintained will be repeat based on the number of GSTINs obtained under a single PAN. The solution to this tedious task may be to maintain records in such a manner so as to capture the GSTIN to which every transaction pertains, separately, so as to enable to person to extract only such of those transactions relevant to a particular GSTIN.
2. **Separate book-keeping practices for GST law:** The registered person is liable to record the details of all supplies, whether or not the supplies are considered to be supplies under the accounting standards or any such requirement under other statutes. While some transactions would have a netting-off effect - such as stock transfers, certain other transactions may not form part of the revenue of the entity - such as permanent disposal of a business asset without consideration / supply valued under the

valuation rules wherein the consideration actually received is different from the value of supply for the purpose of the GST laws. One must exercise utmost caution to attend to all such transactions with a view to ensuring that the financial statements are not misreported with details relevant only from the GST-standpoint. E.g. Credit notes not fulfilling conditions under the GST law cannot reduce the value of supply, while the books of account would reflect reduction in the value.

3. **Meaning of 'annual audited accounts':** The law requires a registered person having an aggregate turnover exceeding Rs.2 Crore to get his books of account audited, and to submit a copy of the annual audited accounts. In this regard, clarity is required as to whether :
 - (a) The financial statements of the person are to be statutorily audited (for the PAN); or
 - (b) For a particular GSTIN the GST auditor is required to prepare separate financial statements i.e., the Balance sheet & Statement of profit and loss for the said GSTIN).
4. **Books in respect of 'non-monetary' transactions:** The law makes no concession in respect of transactions that are underlying for 'non-monetary' consideration. As such, care must be taken to document through identifiable invoice (may be, separate series) and corresponding disclosure (for time and place of supply) and the basis for such non-monetary transactions so that they are tracked separately.

35.5 FAQs

Q1. Where should the books and other records u/s 35 be maintained?

Ans. Such records shall be maintained at his principal place of business, as mentioned in the certificate of registration. If more than one place of business is specified in the certificate, records relating to each place of business should be maintained at that place.

Q2. What are the records that are to be maintained u/s 35?

Ans. The following records are to be maintained u/s 35:

- (i) Production or manufacture of goods;
- (ii) Inward or outward supply of goods or services or both;
- (iii) Stock of goods;
- (iv) Input tax credit availed;
- (v) Output tax payable and paid; and
- (vi) Such other as may be prescribed.

Q3. In case, more than one place of business is specified in the certificate of registration, can the assessee choose to maintain records at a single place for all the places within that State?

Ans. No, in such cases, the accounts and records relating to each place of business shall be kept at such places of business concerned.

Q4. Whether the records are to be maintained physically or in electronic form?

Ans. The records need to be maintained physically. In case they are maintained in electronic form, then they must conform to such procedures as may be prescribed.

Q5. Apart from the records maintained above are there any additional document to be submitted/maintained?

Ans. Section 35(5) obligates an assessee who is required to get his accounts audited to file an electronic reconciliation statement and assessee is obliged to submit such a statement in addition to the audited statement of accounts and other documents and records prescribed.

Q6. Who can conduct audit of taxpayers?

Ans. Every registered person whose turnover exceeds the prescribed limit, shall get his accounts audited by a chartered accountant or a cost accountant. (Section 35(5) of the CGST/SGST Act)

35.5 MCQs

Q1. The books and other records u/s 35 are to be maintained at ____

- (a) Place where the books of account are maintained.
- (b) Principal place of business mentioned in the Registration Certificate.
- (c) Place of address of the Proprietor/ Partner / Director / Principal Officer, etc.
- (d) Any of the above.

Ans. (b) Principal place of business mentioned in the Registration Certificate

Q2. In case, more than one place of business situated within a State are specified in the Registration Certificate, books and other records shall be maintained at ____

- (a) Each place of business
- (b) At the principal place of business mentioned in the Registration Certificate for all places of business in each State.
- (c) Place where the books of account are maintained for all places situated within a State.
- (d) Any place of business in a State pertaining to all places situated within that State.

Ans. (a) Each place of business

Q3. Which of the following is true?

- (a) The assessee can maintain some records with prior permission of the Commissioner.
- (b) The assessee is obligated to maintain such additional records as the Commissioner may notify.
- (c) The assessee can maintain only records notified thereto by the Commissioner.
- (d) The specified class of assessee are obligated to maintain such additional or other records as the Commissioner may notify.

Ans. (d) The specified class of assessee are obligated to maintain such additional or other records as the Commissioner may notify.

Statutory provisions

36. Period of retention of accounts

Every registered person required to keep and maintain books of account or other records in accordance with the provisions of sub-section (1) of section 35 shall retain them until the expiry of seventy-two months from the due date of furnishing of annual return for the year pertaining to such accounts and records:

Provided that a registered person, who is a party to an appeal or revision or any other proceedings before any Appellate Authority or Revisional Authority or Appellate Tribunal or court, whether filed by him or by the Commissioner, or is under investigation for an offence under Chapter XIX, shall retain the books of account and other records pertaining to the subject matter of such appeal or revision or proceedings or investigation for a period of one year after final disposal of such appeal or revision or proceedings or investigation, or for the period specified above, whichever is later.

Related provisions of the Statute

Section or Rule	Description
Section 35	Accounts and other records
Section 44	Annual return

36.1. Introduction

This section provides for the period up to which records and accounts must be retained by the registered person.

36.2. Analysis

- (i) Every registered person is required to mandatorily retain the books of accounts and

other records until the expiry of 72 months (6 years) from the due date for filing of Annual Return for the year, i.e., 81 months from the end of the financial year pertaining to such accounts and records.

For instance, the books of account and other records for FY 2017-18 are to be maintained till 31.12.2024, regardless of the actual date of filing of annual return for the year, considering that the due date for furnishing the annual return is 30.06.2019 (extended due date).

- (ii) This time period is more than the time limit prescribed in Section 62(1) for issuance of order of assessment i.e., 5 years from the due date for filing of annual return or date of erroneous refund (as applicable) in cases of fraud, wilful mis-statement, suppression of facts, etc. (in the above example, the order of assessment shall be issued by 31.12.2023).
- (iii) In case an appeal or revision or any other proceeding is pending before any Appellate Authority or Revisional Authority or Appellate Tribunal or Court, or in case the registered person is under investigation for an offence under Chapter XIX, he shall retain the books of account and other records pertaining to the subject matter of such appeal or revision or proceeding or investigation for a period of one year after final disposal of such appeal or revision or proceeding, even after the expiry of 72 months from the due date for furnishing the annual return.

36.3. Comparative Review

- Rule 5(3) of Service Tax Rules, 1994 provides that all records shall be preserved for a period of five years immediately after the financial year to which such records pertain.
- Chapter 6 of the CBEC's Central Excise Manual obligates every assessee to maintain the records for a period of five years immediately after the financial year to which such records pertain.
- Different State VAT laws prescribe different time periods for maintenance of records. However, many States prescribed a period of five years.
- Where the proceedings are pending in appeal, revision etc., the records are generally maintained till the proceedings are finally concluded, though this is not specifically stipulated in the erstwhile laws. In fact, the books and records are required to be maintained till the time frame for revision proceedings stand open and are not barred by limitation of period.

36.4 Issues and concerns

Due date of annual return: In the event the due date to furnish the annual return is amended for any reason, the registered person must bear in mind that the requirement to maintain the records would also stand according extended. For instance, say the due date to furnish the

annual return for FY 2017-18 is extended to 30-June-2019 for whatever reason, the period of retention would be 30-June-2025 and not 31-Dec-2024.

36.5. FAQs

Q1. Is a separate time limit for maintenance of records specified where an assessee is involved in any litigation?

Ans. In case an assessee is a party to an appeal or revision or any other proceeding before any Appellate Authority or Revisional Authority or Appellate Tribunal or Court, (as an appellant or a respondent), or where he is under investigation for an offence under Chapter XIX, then he shall retain the books of account and other records pertaining to the subject matter of such appeal or revision or proceeding or investigation for a period of 1 year after final disposal of such appeal or revision or proceeding, or for the period specified records u/s 36(1), whichever is later.

Q2. Who is responsible for the maintenance of proper accounts related to job work ?

Ans. The responsibility for the maintenance of proper accounts of job work-related inputs and capital goods rests with the principal.

Q3. What action can be taken for transportation of goods without valid documents or attempted to be removed without proper record in books?

Ans. If any person transports any goods or stores any such goods while in transit without the documents prescribed under the Act (i.e. invoice and a declaration) or supplies or stores any goods that have not been recorded in the books or accounts maintained by him, then such goods shall be liable for detention along with any vehicle on which they are being transported. Such goods shall be released only on payment of the applicable tax and penalty or upon furnishing of security.

36.6. MCQs

Q1. The time limit for up keep and maintenance of the books of account or other records u/s 36 is?

- (a) seventy-two months from the date of filing of Annual Return or due date of filing the Annual Return, whichever is earlier.
- (b) five years from the due date for filing of Annual Return.
- (c) seventy-two months from the due date of filing of Annual Return.
- (d) None of the above.

Ans. (c) seventy-two months from the due date of filing of Annual Return

Q2. In case, the assessee is a party to an appeal or revision or any other proceeding before any Appellate Authority or Appellate Tribunal or Court, (as an appellant or a respondent), then the time limit for retaining the records shall be ____

- (a) Up to the final disposal of such appeal or revision or proceeding.
 - (b) One year after final disposal of such appeal or revision or proceeding, or for the period specified records u/s 36(1), whichever is earlier.
 - (c) Six months after final disposal of such appeal or revision or proceeding, or for the period specified records u/s 47(1), whichever is later.
 - (d) One year after final disposal of such appeal or revision or proceeding, or for the period specified records u/s 36(1), whichever is later.
- Ans. (d) One year after final disposal of such appeal or revision or proceeding, or for the period specified records u/s 36(1), whichever is later.

Chapter 10

Returns

Sections	Rules
37. Furnishing details of outward supplies	59. Form and manner of furnishing details of outward supplies
38. Furnishing details of inward supplies	60. Form and manner of furnishing details of inward supplies
39. Furnishing of returns	61. Form and manner of submission of monthly return
40. First return	62. Form and manner of submission of quarterly return by the composition supplier
41. Claim of input tax credit and provisional acceptance thereof	63. Form and manner of submission of return by non-resident taxable person
42. Matching, reversal and reclaim of input tax credit	64. Form and manner of submission of return by persons providing online information and database access or retrieval services
43. Matching, reversal and reclaim of reduction in output tax liability	65. Form and manner of submission of return by an Input Service Distributor
43A. Procedure for furnishing return and availing input tax credit.	66. Form and manner of submission of return by a person required to deduct tax at source
44. Annual return	67. Form and manner of submission of statement of supplies through an e-commerce operator
45. Final return	68. Notice to non-filers of returns
46. Notice to return defaulters	69. Matching of claim of input tax credit
47. Levy of late fee	70. Final acceptance of input tax credit and communication thereof
48. Goods and services tax practitioners	71. Communication and rectification of discrepancy in claim of input tax credit and reversal of claim of input tax credit

	<p>72. Claim of input tax credit on the same invoice more than once</p> <p>73. Matching of claim of reduction in the output tax liability</p> <p>74. Final acceptance of reduction in output tax liability and communication thereof</p> <p>75. Communication and rectification of discrepancy in reduction in output tax liability and reversal of claim of reduction</p> <p>76. Claim of reduction in output tax liability more than once</p> <p>77. Refund of interest paid on reclaim of reversals</p> <p>78. Matching of details furnished by the e-Commerce operator with the details furnished by the supplier</p> <p>79. Communication and rectification of discrepancy in details furnished by the ecommerce operator and the supplier</p> <p>80. Annual return</p> <p>81. Final return</p> <p>82. Details of inward supplies of persons having Unique Identity Number</p> <p>83. Provisions relating to a goods and services tax practitioner.</p> <p>83A. Examination of Goods and Services Tax Practitioners.</p> <p>84. Conditions for purposes of appearance</p>
--	--

Returns under the GST Law

FORM	PARTICULARS	DUE DATE	APPLICABLE TO
GSTR-3B	Monthly summary return	20 th of the next month (to be continued till June, 2019)	All registered persons (other than Input Service Distributor (ISD), person liable to deduct TDS and personal liable to collect tax at source).
GSTR-1	Outward Supplies > 1.5 Crore Outward Supplies < 1.5 Crore	11 th of the next month Last date of month subsequent to the quarter	Normal / Regular Taxpayer
GSTR-2	Inward Supplies	15 th of the next month (Deferred till June, 2019)	Normal / Regular Taxpayer
GSTR-3	Monthly return [periodic]	20 th of the next month (Deferred till June, 2019)	Normal / Regular Taxpayer
GSTR-4	Return by compounding tax payers	18 th of the month succeeding the quarter	Composition taxpayer
GSTR-5	Return by non-resident tax payers [foreigners]	20 th of the next month or within 7 days after expiry of registration, whichever is earlier	Non-Resident taxpayer
GSTR-5A	Monthly Return by Online information and database access or retrieval services (supply to a person other than a registered person i.e., online non-taxable recipient)	20 th of the next month	Online information and database access or retrieval services
GSTR-6	Monthly Return by input service distributors	13 th of the next month	Input Service Distributor
GSTR-7	Monthly Return for TDS	10 th of the next month	Tax Deductor

GSTR-8	Monthly Return (Statement) for Collection of Tax at Source	10 th of the next month	E-Commerce Operator
GSTR-9	Annual return	31 st December of the next Financial Year FY 2017-18 has been extended till 30 th June, 2019	Normal tax payer (other than casual tax payer)
GSTR-9A	Annual return by Composition Supplier	31 st December of the next Financial Year FY 2017-18 has been extended till 30 th June, 2019	Compounding Taxpayer
GSTR-9C	Annual return along with the copy of audited annual accounts and a reconciliation statement	31 st December of the next Financial Year FY 2017-18 has been extended till 30 th June, 2019	Normal tax payer having aggregate turnover of more than ₹ 2 crores
GSTR-10	Final Return	Within 3 months of the date of cancellation or date of order of cancellation, whichever is later	Registered Person whose registration has been cancelled
GSTR-11	Return to be filed by a person having UIN (Unique Identity Number) w.r.t inward supplies received by him to file refund of the taxes paid by him on inward supplies.		Person having UIN

Note: Above due dates have been extended from time to time. Please refer Annexure-'A' for the details of extended due dates and relevant notification(s).

Statutory Provisions**37. Furnishing details of outward supplies**

- (1) Every registered taxable person, other than an input service distributor, a non-resident taxable person and a person paying tax under the provisions of section 10, section 51 or section 52, shall furnish, electronically, in such form and manner as may be prescribed, the details of outward supplies of goods or services or both effected, during a tax period on or before the tenth day of the month succeeding the said tax period and such details shall be communicated to the recipient of the said supplies within the time and in the manner as may be prescribed:

Provided that the registered person shall not be allowed to furnish the details of outward supplies during the period from the eleventh day to the fifteenth day of the month succeeding the tax period:

Provided further that the Commissioner may, for reasons to be recorded in writing, by notification, extend the time limit for furnishing such details for such class of taxable persons as may be specified therein:

Provided also that any extension of time limit notified by the Commissioner of State tax or Commissioner of Union territory tax shall be deemed to be notified by the Commissioner

- (2) Every registered person who has been communicated the details under sub-section (3) of section 38 or the details pertaining to inward supplies of Input Service Distributor under sub-section (4) of section 38, shall either accept or reject the details so communicated, on or before the seventeenth day, but not before the fifteenth day, of the month succeeding the tax period and the details furnished by him under sub-section (1) shall stand amended accordingly.
- (3) Any registered person, who has furnished the details under sub-section (1) for any tax period and which have remained unmatched under section 42 or section 43, shall, upon discovery of any error or omission therein, rectify such error or omission in such manner as may be prescribed, and shall pay the tax and interest, if any, in case there is a short payment of tax on account of such error or omission, in the return to be furnished for such tax period:

Provided that no rectification of error or omission in respect of the details furnished under sub-section (1) shall be allowed after furnishing of the return under section 39 for the month of September following the end of the financial year to which such details pertain, or furnishing of the relevant annual return, whichever is earlier

“Provided further that the rectification of error or omission in respect of the details furnished under sub-section (1) shall be allowed after furnishing of the return under section 39 for the month of September, 2018 till the due date for furnishing the details under sub-section (1) for the month of March, 2019 or for the quarter January, 2019 to March, 2019.”

Explanation.—For the purposes of this Chapter, the expression “details of outward supplies” shall include details of invoices, debit notes, credit notes and revised invoices issued in relation to outward supplies made during any tax period

Extract of the CGST Rules, 2017

59 Form and manner of furnishing details of outward supplies

- (1) Every registered person, other than a person referred to in section 14 of the Integrated Goods and Services Tax Act, 2017, required to furnish the details of outward supplies of goods or services or both under section 37, shall furnish such details in FORM GSTR-1 electronically through the common portal, either directly or through a Facilitation Centre notified by the Commissioner.
- (2) The details of outward supplies of goods or services or both furnished in FORM GSTR-1 shall include the—
 - (a) invoice wise details of all -
 - (i) inter-State and intra-State supplies made to the registered persons; and
 - (ii) inter-State supplies with invoice value more than two and a half lakh rupees made to the unregistered persons;
 - (b) consolidated details of all -
 - (i) intra-State supplies made to unregistered persons for each rate of tax; and
 - (ii) State wise inter-State supplies with invoice value upto two and a half lakh rupees made to unregistered persons for each rate of tax;
 - (c) debit and credit notes, if any, issued during the month for invoices issued previously.
- (3) The details of outward supplies furnished by the supplier shall be made available electronically to the concerned registered persons (recipients) in Part A of FORM GSTR-2A, in FORM GSTR-4A and in FORM GSTR-6A through the common portal after the due date of filing of FORM GSTR-1.
- (4) The details of inward supplies added, corrected or deleted by the recipient in his FORM GSTR-2 under section 38 or FORM GSTR-4 or FORM GSTR-6 under section 39 shall be made available to the supplier electronically in FORM GSTR-1A through the common portal and such supplier may either accept or reject the modifications made by the recipient and FORM GSTR-1 furnished earlier by the supplier shall stand amended to the extent of modifications accepted by him.

Related provisions of the Statute:

Section or Rule	Description
Section 2(82)	Definition of Output Tax
Section 2(83)	Definition of Outward Supply

Section 2(94)	Definition of Registered Person
Section 2(97)	Definition of Return
Section 2(117)	Definition of Valid Return
Section 16	Eligibility and Conditions for Taking Input Tax Credit
Section 17	Apportionment of Credits and Blocked Credits
Section 22	Persons liable for registration
Section 24	Compulsory registration in certain cases
Section 38	Furnishing details of inward supplies
Section 39	Furnishing of Returns
Section 47	Levy of late fee
Section 14 (IGST)	Special provision for payment of tax by a supplier of online information and database access or retrieval services.

37.1 Introduction

This provision relates to furnishing of details of outward supplies by the supplier.

37.2 Analysis

- (a) A return of Outward supplies in terms of this section should be furnished by every registered taxable person except for the following persons namely,
- Input service distributor
 - A non-resident taxable person
 - A person paying tax under the provisions of section 10 (composition levy)
 - A person paying tax under the provisions of section 51 (TDS)
 - A person remitting tax collected under the provisions of section 52 (TCS)
 - A person referred to in Section 14 of IGST Act – Person providing Online Information and Data Access & Retrieval Services to a non-taxable online recipient.
- (b) Explanation to section 37 relating to furnishing of the “details of outward supplies” shall include details of Invoices, debit notes, credit notes and revised invoices issued in relation to outward supplies made during any tax period. This e-return shall be filed within 11 days from the end of the tax period in **FORM GSTR-1 in case of taxpayer having turnover more than Rs 1.5 Crore. (Refer Annexure ‘A’ for extension of due date for filing GSTR-1).**
- (c) Such returns shall be for supply of goods or services or both as effected during a tax period and shall be filed electronically.

- (d) The Commissioner is empowered to notify any extension of due date of filing, for any class of persons, beyond the tenth of the succeeding month, with reasons to be recorded in writing. Refer to Annexure 'A' at the end of the chapter, for extensions notified, from time to time, for various returns.
- (e) The details provided by the supplier in GSTR-1 shall be auto-populated and made available electronically to the recipient, for matching purposes, in accordance with the provision of Rule 60 in a **FORM GSTR-2A, which can be used for reconciliation and filing of GSTR-9 i.e Annual return.**
- (f) The present process of return filing, envisages that the recipient of the supply shall be provided an opportunity to accept, reject, amend or delete the details in a two-way communication process. This opportunity is not available at present as filing of GSTR-2 has been deferred.
- (g) If any error or omission is discovered in the course of matching as specified in the Act and discussed under Section 42 and 43, rectifications of the same shall be effected; and tax and interest, if any, as applicable shall be paid on such corrections by the person responsible for filing the return of outward supplies. Section 42 and section 43 are currently not applicable as the due dates for filing of details in GSTR-2 is yet to be notified.
- (h) Such rectification of error or omission, however, is not permitted after filing of annual return or the return for the month of September of the following financial year to which the details pertain to, whichever is earlier. However, GST council has decided to provide relaxation to the tax payer for the financial year 2017-18 vide the Central Goods and Services Tax (Second Removal of Difficulties) Order, 2018, after considering the fact that financial year 2017-18 was the first year of the implementation of the Goods and Services Tax in India and the taxpayers were still in the process of familiarising themselves with the new taxation system and due to lack of said familiarity-
- (i) the registered persons eligible to avail input tax credit could not claim the same in terms of provisions of section 16 because of missing invoices or debit notes referred to sub-section (4) within the stipulated time;
 - (ii) the registered persons could not rectify the error or omission in terms of provisions of sub-section (3) of section 37 within the stipulated time

Therefore, any error or omission pertaining to the financial year 2017-18 can be rectified till the due date for furnishing the details under sub-section (1) for the month of March, 2019 or for the quarter January, 2019 to March, 2019.

For example: Assume an entity has furnished the annual returns for the year 2018-19 on August 15, 2019. If an error is discovered in respect of a transaction pertaining to the tax period July 2018, where the entity has filed its returns for the month of September 2019 on

October 18, 2019. In this case, the rectification of the error pertaining to a transaction in July 2018 cannot be made beyond August 15, 2019. This is because the said entity has already filed its annual return on 15th August, 2019.

Linking E-Way Bill with GSTR-1

Every registered person who causes movement of goods of consignment value exceeding Rs. 50,000/- or Rs. 1,00,000/- as the case may be, in relation to supply, or for reason other than supply such as sale of goods on approval basis, job work etc., or due to inward supply from an unregistered person excluding exempted goods needs to furnish information relating to the said goods and thereby, furnish details of invoices while generating e-way bills. Further, the invoice details for business to business supplies have to be given in FORM GSTR-1 by the tax payer. To avoid duplicate data entry, GSTN has provided a facility to taxpayers, where e-way bill data of a tax period can be imported by the taxpayer in their FORM GSTR-1. If the number of e-way bills generated in a month are:

- upto 50 only, the invoice details can be directly imported into the respective Tab of Form GSTR 1, without using the offline tool.
- more than 50 but less than 500, invoices can be downloaded in three separate CSV files with data pertaining to B2B transactions, B2CL transactions and HSN summary. These files can then be imported into FORM GSTR-1 offline tool.
- more than 500, the invoice details in respect of B2B transactions, B2CL transactions and HSN summary can be imported from E-Way Bill portal in a single excel file. This file can then be imported into FORM GSTR-1 offline tool.

However, the data so imported can be edited while filing FORM GSTR-1.

It is pertinent to mention here that 'import EWB data' option in the GSTN portal and selection of requisite data of invoices to be uploaded in the GSTR-1 is an option, made available to ease the return filing procedure and the same is not mandatory. Where the user decides not to use the option, details of such invoices are to be filed manually.

Matching details given in FORM GSTR-1 with those given in the e-way bill will curb tax evasion as evident from certain facts revealed like some transporters are doing multiple trips by generating only a single e-way bill or not reflecting invoices for which e-way bill is generated while filing FORM GSTR-1 or e-way bill is not being generated even as supplies are being made etc.

However, certain points to be considered while reconciling e-way bills generated with the data declared in GST returns so that frivolous demands are not raised:

- movement of goods over and above a threshold limit require generation of e-way bill while data declared in FORM GSTR-1 includes all the supplies regardless of any threshold,
- in case of supply of services, no e-way bill is required to be issued while the same needs to be duly reported in FORM GSTR-1,

- varied State-specific requirements, such as different threshold limits and notified products for which e-way bills are required,
- reconciliation of the value of supplies considering the credit notes (tax or financial) issued later by the supplier to factor the discounts, deficiency, etc. for the customer,
- In case where goods are transported by job worker, the e-way bill will be generated on the basis of Delivery Challan and not on the basis of tax invoice issued by job worker for job work charges. The value of goods moved on the basis of Delivery Challan is not to be reported in FORM GSTR-1 and neither there is mention of tax invoice issued by job worker for job work charges in e-way bill, therefore, no data would be auto-populated in FORM GSTR-1 of the job worker.

Components of valid GST Return for Outward Supplies made by the Taxpayer (FORM GSTR-1)

This Statement of outward supplies would capture the following information:

1. GSTIN
2. Name
3. Period to which the return pertains
4. Aggregate turnover of the taxpayer in the previous Financial Year. This information would be submitted by the taxpayers only in the first year, first tax period and will be auto-populated in subsequent tax periods and years.
5. The transactions of outward supplies is required to be furnished in the said Statement i.e., Form GSTR 1 at an invoice / consolidated level, as per the requirements laid down in law / rules which is as mentioned in the below table:

Table 1: Submission of information at Invoice level.

Table 2: Submission of information at consolidated (Place of supply) level.

Table 1

Type	Supplies made to	Invoice Value	Level of submission
Inter-State	Registered Persons	Any	Invoice level
	Registered Persons	Any	Invoice level
	Unregistered Persons (stated as Consumer in the return)	> 250,000	Invoice level
	Credit Notes for the above		Invoice Level Submission

Table 2

Type	Supplies made to	Invoice Value	Level of submission
Intra-State	Unregistered Persons	Any	Consolidated
	Unregistered Persons (stated as Consumer in the return)	< 250,000	Consolidated
	All Exempted Supplies	Any	Consolidated

Note: For all B2C supplies (whether inter-State or intra-State) where invoice value is up to ₹ 2,50,000/- State-wise and rate-wise summary of supplies should be uploaded in Table 7 of the Form GSTR-1.

Additional Comments: Every registered person furnishing any statement or return or making any application, shall make sure that they have read the instructions provided by GSTN which is to be followed by every registered person furnishing such statement / return / application. The said instruction is available in the format(s) of Form(s) prescribed in CGST Rules, 2017 as well as at the offline utility of each of the Statement / Return / Application.

Illustration:

- 1. HSN requirement:** HSN summary to be provided in Table 12 of Form GSTR 1 is divided into three parts i.e., (a) every registered person with annual turnover above ₹ 1.5 Crore but below ₹ 5 Crore in the preceding FY, is required to furnish details of supply HSN wise atleast at 2 digit level; (b) person with annual turnover above ₹ 5 Crore is required to provide details of outward supplies at 4 digit level; and (c) supplier not falling under (a) or (b) above, is required to provide details of goods supplied at the level of description of goods supplied.

Further, Unit Quantity Code (UQC) for which no specific unit of measurement is available, shall be selected as 'OTHERS' for example in case of supply of services, UQC can be on the basis of number of invoices issued under particular HSN for a particular tax period.

It is also important to note that, HSN Summary or summary of supplies at description of goods / services level, shall also contain details of supplies which are exempt from payment of tax or is not liable to Goods and Service Tax i.e., non-taxable supply (example supply of alcoholic liquor meant for human consumption).

- 2. Furnishing of details of Physical Exports as against supplies made to SEZ unit or SEZ developer / Deemed Exports:** Details of Physical export of goods or services or both are to be separately furnished in Table 6A of Form GSTR 1.

37.3 Comparative Review

Under all the earlier laws, which is been subsumed into GST, there was no concept of

furnishing a statement of outward supplies for the purpose of matching outward supplies with the input tax credit availed by the recipient of such supply. However, VAT laws of few States such as Karnataka had the facility of e-UPaSS which was introduced with the intent of matching output tax paid by the seller with that of input tax credit availed. However, the said activity was never carried out even as part of assessment under respective State VAT Laws.

37.4 Issues and Concerns

- (i) It is important for every registered person to note that the details of all outward supplies made by him is to be furnished in Form GSTR 1 i.e., statement of outward supplies, irrespective of the fact, whether such supply is outside the umbrella of GST or exempted from payment of tax i.e., GST, by way of exemption notification or is it a supply of notified goods or services which is liable to tax in the hands of recipient. The reason for disclosure is **(1)** the law requires one to provide details of such supplies though not liable to tax; **and (2)** as a registered person, by disclosing the values of all supplies, the registered person is effecting a reconciliation of financial statements with that of statements / returns furnished.
- (ii) Person effecting zero-rated supplies (physical export of goods), who wishes to claim refund of taxes paid has to ensure that details relating to such supplies as provided in GSTR 1, like invoice no., shipping bill details, value of goods exported and amount of IGST paid match with the details as available in the ICEGATE system. Only on matching of such details, refund of tax paid will be granted. Therefore, it is important that every registered person making physical export of goods verifies whether details of all export invoices as provided in GSTR 1 matches with details available in customs in ICEGATE.

The same can be verified by logging in to www.gst.gov.in with valid credentials and following the below mentioned steps:

Refunds >> Track Status of Invoice data to be shared with ICEGATE

Note: If the difference in the value of IGST paid is more than ₹ 100, between values disclosed in Form GSTR 3B and that of Form GSTR 1, the information will not be shared by GSTN for verification by ICEGATE, in such cases one has to first ensure that there is parity in the value disclosed in Form GSTR 3B and Form GSTR 1 by amending the details as required.

Statutory Provisions

38. Furnishing details of inward supplies

- (1) *Every registered person, other than an Input Service Distributor or a non-resident taxable person or a person paying tax under the provisions of section 10, section 51 or section 52, shall verify, validate, modify or delete, if required, the details relating to outward supplies and credit or debit notes communicated under sub-section (1) of section 37 to prepare the details of his inward supplies and credit or debit notes and*

may include therein, the details of inward supplies and credit or debit notes received by him in respect of such supplies that have not been declared by the supplier under sub-section (1) of section 37.

- (2) Every registered person, other than an Input Service Distributor or a non-resident taxable person or a person paying tax under the provisions of section 10 or section 51 or section 52, shall furnish, electronically, the details of inward supplies of taxable goods or services or both, including inward supplies of goods or services or both on which the tax is payable on reverse charge basis under this Act and inward supplies of goods or services or both taxable under the Integrated Goods and Services Tax Act or on which integrated goods and services tax is payable under section 3 of the Customs Tariff Act, 1975, and credit or debit notes received in respect of such supplies during a tax period after the tenth day but on or before the fifteenth day of the month succeeding the tax period in such FORM and manner as may be prescribed:

Provided that the Commissioner may, for reasons to be recorded in writing, by notification, extend the time limit for furnishing such details for such class of taxable persons as may be specified therein:

Provided further that any extension of time limit notified by the Commissioner of State tax or Commissioner of Union territory tax shall be deemed to be notified by the Commissioner

- (3) The details of supplies modified, deleted or included by the recipient and furnished under sub-section (2) shall be communicated to the supplier concerned in such manner and within such time as may be prescribed
- (4) The details of supplies modified, deleted or included by the recipient in the return furnished under sub-section (2) or sub-section (4) of section 39 shall be communicated to the supplier concerned in such manner and within such time as may be prescribed.
- (5) Any registered person, who has furnished the details under sub-section (2) for any tax period and which have remained unmatched under section 42 or section 43, shall, upon discovery of any error or omission therein, rectify such error or omission in the tax period during which such error or omission is noticed in such manner as may be prescribed, and shall pay the tax and interest, if any, in case there is a short payment of tax on account of such error or omission, in the return to be furnished for such tax period:

Provided that no rectification of error or omission in respect of the details furnished under sub-section (2) shall be allowed after furnishing of the return under section 39 for the month of September following the end of the financial year to which such details pertain, or furnishing of the relevant annual return, whichever is earlier.

Extract of the CGST Rules, 2017

60 Form and manner of furnishing details of inward supplies

- (1) Every registered person, other than a person referred to in section 14 of the Integrated Goods and Services Tax Act, 2017, required to furnish the details of inward supplies of goods or services or both received during a tax period under sub-section (2) of section 38 shall, on the basis of details contained in Part A, Part B and Part C of FORM GSTR-2A, prepare such details as specified in sub-section (1) of the said section and furnish the same in FORM GSTR-2 electronically through the common portal, either directly or from a Facilitation Centre notified by the Commissioner, after including therein details of such other inward supplies, if any, required to be furnished under sub-section (2) of section 38.
- (2) Every registered person shall furnish the details, if any, required under sub-section (5) of section 38 electronically in FORM GSTR-2.
- (3) The registered person shall specify the inward supplies in respect of which he is not eligible, either fully or partially, for input tax credit in FORM GSTR-2 where such eligibility can be determined at the invoice level.
- (4) The registered person shall declare the quantum of ineligible input tax credit on inward supplies which is relatable to non-taxable supplies or for purposes other than business and cannot be determined at the invoice level in FORM GSTR-2.
- (4A) The details of invoices furnished by a non-resident taxable person in his return in FORM GSTR-5 under rule 63 shall be made available to the recipient of credit in Part A of FORM GSTR 2A electronically through the common portal and the said recipient may include the same in FORM GSTR-2.
- (5) The details of invoices furnished by an Input Service Distributor in his return in FORM GSTR-6 under rule 65 shall be made available to the recipient of credit in Part B of FORM GSTR 2A electronically through the common portal and the said recipient may include the same in FORM GSTR-2.
- (6) The details of tax deducted at source furnished by the deductor under sub-section (3) of section 39 in FORM GSTR-7 shall be made available to the deductee in Part C of FORM GSTR-2A electronically through the common portal and the said deductee may include the same in FORM GSTR-2.
- (7) The details of tax collected at source furnished by an e-commerce operator under section 52 in FORM GSTR-8 shall be made available to the concerned person in Part C of FORM GSTR 2A electronically through the common portal and such person may include the same in FORM GSTR-2.
- (8) The details of inward supplies of goods or services or both furnished in FORM GSTR-2 shall include the-

- | |
|---|
| <p>(a) <i>invoice wise details of all inter-State and intra-State supplies received from registered persons or unregistered persons;</i></p> <p>(b) <i>import of goods and services made; and</i></p> <p>(c) <i>debit and credit notes, if any, received from supplier.</i></p> |
|---|

Related provisions of the Statute

Section or Rule	Description
Section 2(62)	Definition of Input Tax
Section 2(67)	Definition of Inward Supply
Section 2(94)	Definition of Registered Person
Section 2(97)	Definition of Return
Section 2(117)	Definition of Valid Return
Section 16	Eligibility and Conditions for Taking Input Tax Credit
Section 17	Apportionment of Credits and Blocked Credits
Section 22	Persons liable for registration
Section 24	Compulsory registration in certain cases
Section 37	Furnishing details of Outward supplies
Section 39	Furnishing of Returns
Section 47	Levy of late fee
Section 14 (IGST)	Special provision for payment of tax by a supplier of online information and database access or retrieval services.

38.1 Introduction

This provision relates to furnishing of details of inward supplies by the recipient on the basis of details of outward supplies uploaded by the supplier(s) in Form GSTR 1.

38.2 Analysis

- (a) In respect of the return for outward supplies filed by the supplier of goods / services (under section 37 of CGST / SGST Act, 2017), recipient of supply is required to match his inward supply details with that of the details uploaded by the supplier by way of furnishing Form GSTR 1.
- (b) The details uploaded by the supplier will be made available to the recipient in Part 'A' of Form GSTR 2A (the details of input tax credit distributed by input service distributor will be made available in Part 'B' of said Form i.e., Form GSTR 2A). The details will be available for verification as and when the supplier has furnished Form GSTR 1. The details of tax deducted at source and tax collected at source will be made available in Part 'B' of Form GSTR 2A and the activities as specified supra for Part 'A' can be done

i.e., accept / modify / reject / add, for values made available to the recipient of supply in Part 'B' of the said form.

Part A of FORM GSTR 2A will contain the following details (auto-populated on basis of Form GSTR 1 submitted by supplier).

Sl. No. of Form 2A	Content of FORM GSTR 1 of supplier
3	Inward supplies received from a registered person other than the supplies attracting reverse charge.
4	Inward supplies received from a registered person on which tax is to be paid on reverse charge.
5	Debit / Credit notes (including amendments thereof) received during current tax period.

Note: The filing of Form GSTR-2 has been suspended for the time being and same will be notified by way of notification.

- (c) In case, any error or omission is discovered in the course of matching as specified in the Act and discussed under Section 42 and 43, rectifications of the same shall be effected and tax and interest, if any as applicable shall be paid on such corrections by the person responsible for filing the return of inward supplies.
- (d) Such rectification of error or omission, however, is not permitted after filing of annual return or before the due date for filing the return for the month of September of the following financial year to which the details pertain, whichever is earlier.

38.2 Issues and Concerns

- (i) The GST Council / GSTN is effecting a number of modifications in the modules to the returns and more changes to the same are expected to be made in the near future. In this regard, as a recipient of supply one would have to be cautious since uploading of the supply details is by his suppliers by way of filing of GSTR 1 (for the period beginning July 2017 till date new system of return is made available). The Recipient will only download and verify such details in Form GSTR 2A. The Recipient should ensure that, all his inward supplies on which he has availed input tax credit has been uploaded by his supplier and the details of the same is available in Form GSTR 2A. By this, recipient of supply can avoid interest liability on availment of excess credit (in the eyes of exchequer) which may also effect his Goods and Service Tax Compliance rating in long run.
- (ii) Further, recipient of credit shall be aware of the fact that, input tax credit in relation to supply received in a particular financial year say 2018-19 (including transactions of credit / debit notes as the case may be), if not availed earlier, is to be availed on or before the due date prescribed for filing of return for the month of September 2019 or date of filing of annual return in Form GSTR 9, whichever is earlier. On this aspect law

would be sacrosanct and may not allow additional time which will result in losing out on input tax credit.

Additional Comments

It is important to note that GST Council in its 27th Council Meeting held on 04.05.2018 has approved the principles for the new return design proposed by a Group of Ministers on IT simplification. According to the press release issued by Central Board of Indirect Taxes and Customs, it is recommended that there will be one single return to be furnished by taxpayer every month (except for composition taxpayer). Further uploading of invoices for outward supplies will be allowed on real time basis and the same will be visible to the recipient as and when the invoice(s) is / are uploaded by the supplier.

The recommendations also state that for another six months, returns will have to be filed in Form GSTR 3B and GSTR 1. Input tax credit will be available to the recipient during this phase as well as for six months from the date of introduction of new return proposed on provisional basis *i.e., on the basis of input tax credit availed by the recipient of supply in his return*. However from the date of introduction of proposed return system, details of differences between credit availed by recipient of supply and amount of credit as per the invoices uploaded by the supplier will be made available to the recipient of the supply. After end of Phase 2 of introduction of new return system, availability of input tax credit on provisional basis will be withdrawn *i.e., input tax credit will be available only when the invoice details is uploaded by the supplier i.e., purely on the matching concept basis*.

Also, the proposed return system has taken into consideration unnecessary movement of input tax credit by suppliers who are defaulters of payment of taxes. Default beyond threshold amount will result in blocking of input tax credit to the recipient of supply from such default suppliers.

Statutory Provisions

39. Returns

- (1) *Every registered person, other than an Input Service Distributor or a non-resident taxable person or a person paying tax under the provisions of section 10 or section 51 or section 52 shall, for every calendar month or part thereof, furnish, in such form and manner as may be prescribed, a return, electronically, of inward and outward supplies of goods or services or both, input tax credit availed, tax payable, tax paid and such other particulars as may be prescribed, on or before the twentieth day of the month succeeding such calendar month or part thereof.*
- (2) *A registered taxable person paying tax under the provisions of section 10 shall, for each quarter or part thereof, furnish, in such FORM and manner as may be prescribed, a return, electronically, of turnover in the state or union territory, inward supplies of goods or services or both, tax payable and tax paid within eighteen days after the end of such quarter.*

- (3) *Every registered person required to deduct tax at source under the provisions of section 51 shall furnish, in such form and manner as may be prescribed, a return, electronically, for the month in which such deductions have been made within ten days after the end of such month.*
- (4) *Every taxable person registered as an Input Service Distributor shall, for every calendar month or part thereof, furnish, in such form and in such manner as may be prescribed, a return, electronically, within thirteen days after the end of such month.*
- (5) *Every registered non-resident taxable person shall, for every calendar month or part thereof, furnish, in such form and manner as may be prescribed, a return, electronically, within twenty days after the end of a calendar month or within seven days after the last day of the period of registration specified under sub-section (1) of section 27, whichever is earlier.*
- (6) *The Commissioner may, for reasons to be recorded in writing, by notification, extend the time limit for furnishing the returns under this section for such class of registered persons as may be specified therein*
- Provided that any extension of time limit notified by the Commissioner of State tax or Union territory tax shall be deemed to be notified by the Commissioner.*
- (7) *Every registered person, who is required to furnish a return under sub-section (1) or sub-section (2) or sub-section (3) or sub-section (5), shall pay to the Government the tax due as per such return not later than the last date on which he is required to furnish such return*
- (8) *Every registered person who is required to furnish a return under sub-section (1) or sub-section (2) shall furnish a return for every tax period whether or not any supplies of goods or services or both have been made during such tax period.*
- (9) *Subject to the provisions of sections 37 and 38, if any registered person after furnishing a return under sub-section (1) or sub-section (2) or sub-section (3) or sub-section (4) or sub-section (5) discovers any omission or incorrect particulars therein, other than as a result of scrutiny, audit, inspection or enforcement activity by the tax authorities, he shall rectify such omission or incorrect particulars in the return to be furnished for the month or quarter during which such omission or incorrect particulars are noticed, subject to payment of interest under this Act.*
- Provided that no such rectification of any omission or incorrect particulars shall be allowed after the due date for furnishing of return for the month of September or second quarter following the end of the financial year, or the actual date of furnishing of relevant annual return, whichever is earlier.*
10. *A registered person shall not be allowed to furnish a return for a tax period if the return for any of the previous tax periods has not been furnished by him.*

Extract of the CGST Rules, 2017

61 Form and manner of submission of monthly return

- (1) Every registered person other than a person referred to in section 14 of the Integrated Goods and Services Tax Act, 2017 or an Input Service Distributor or a non-resident taxable person or a person paying tax under section 10 or section 51 or, as the case may be, under section 52 shall furnish a return specified under sub-section (1) of section 39 in FORM GSTR-3 electronically through the common portal either directly or through a Facilitation Centre notified by the Commissioner.
- (2) Part A of the return under sub-rule (1) shall be electronically generated on the basis of information furnished through FORM GSTR-1, FORM GSTR-2 and based on other liabilities of preceding tax periods.
- (3) Every registered person furnishing the return under sub-rule (1) shall, subject to the provisions of section 49, discharge his liability towards tax, interest, penalty, fees or any other amount payable under the Act or the provisions of this Chapter by debiting the electronic cash ledger or electronic credit ledger and include the details in Part B of the return in FORM GSTR-3.
- (4) A registered person, claiming refund of any balance in the electronic cash ledger in accordance with the provisions of sub-section (6) of section 49, may claim such refund in Part B of the return in FORM GSTR-3 and such return shall be deemed to be an application filed under section 54.
- (5) Where the time limit for furnishing of details in FORM GSTR-1 under section 37 and in FORM GSTR-2 under section 38 has been extended and the circumstances so warrant, the Commissioner may, by notification, [specify the manner and conditions subject to which the return shall be furnished in FORM GSTR-3B electronically through the common portal, either directly or through a Facilitation Centre notified by the Commissioner.
- (6) Where a return in FORM GSTR-3B has been furnished, after the due date for furnishing of details in FORM GSTR-2—
 - (a) Part A of the return in FORM GSTR-3 shall be electronically generated on the basis of information furnished through FORM GSTR-1, FORM GSTR-2 and based on other liabilities of preceding tax periods and PART B of the said return shall be electronically generated on the basis of the return in FORM GSTR-3B furnished in respect of the tax period;
 - (b) the registered person shall modify Part B of the return in FORM GSTR-3 based on the discrepancies, if any, between the return in FORM GSTR-3B and the return in FORM GSTR-3 and discharge his tax and other liabilities, if any;
 - (c) where the amount of input tax credit in FORM GSTR-3 exceeds the amount of input tax credit in terms of FORM GSTR-3B, the additional amount shall be credited to the electronic credit ledger of the registered person.

62 Form and manner of submission of quarterly return by the composition supplier

- (1) Every registered person paying tax under section 10 shall, on the basis of details contained in FORM GSTR-4A, and where required, after adding, correcting or deleting the details, furnish the quarterly return in FORM GSTR-4 electronically through the common portal, either directly or through a Facilitation Centre notified by the Commissioner.

Provided that the registered person who opts to pay tax under section 10 with effect from the first day of a month which is not the first month of a quarter shall furnish the return in FORM GSTR-4 for that period of the quarter for which he has paid tax under section 10 and shall furnish the returns as applicable to him for the period of the quarter prior to opting to pay tax under section 10

- (2) Every registered person furnishing the return under sub-rule (1) shall discharge his liability towards tax, interest, penalty, fees or any other amount payable under the Act or the provisions of this Chapter by debiting the electronic cash ledger.
- (3) The return furnished under sub-rule (1) shall include the-
- (a) invoice wise inter-State and intra-State inward supplies received from registered and un-registered persons; and
 - (b) consolidated details of outward supplies made.
- (4) A registered person who has opted to pay tax under section 10 from the beginning of a financial year shall, where required, furnish the details of outward and inward supplies and return under rules 59, 60 and 61 relating to the period during which the person was liable to furnish such details and returns till the due date of furnishing the return for the month of September of the succeeding financial year or furnishing of annual return of the preceding financial year, whichever is earlier.

Explanation.- For the purposes of this sub-rule, it is hereby declared that the person shall not be eligible to avail of input tax credit on receipt of invoices or debit notes from the supplier for the period prior to his opting for the composition scheme.

- (5) A registered person opting to withdraw from the composition scheme at his own motion or where option is withdrawn at the instance of the proper officer shall, where required, furnish the details relating to the period prior to his opting for payment of tax under section 9 in FORM GSTR- 4 till the due date of furnishing the return for the quarter ending September of the succeeding financial year or furnishing of annual return of the preceding financial year, whichever is earlier.

63 Form and manner of submission of return by non-resident taxable person.-

Every registered non-resident taxable person shall furnish a return in FORM GSTR-5 electronically through the common portal, either directly or through a Facilitation Centre notified by the Commissioner, including therein the details of outward supplies and inward supplies and shall pay the tax, interest, penalty, fees or any other amount payable under the Act or the provisions of this Chapter within twenty days after the

end of a tax period or within seven days after the last day of the validity period of registration, whichever is earlier.

64 Form and manner of submission of return by persons providing online information and database access or retrieval services

Every registered person providing online information and data base access or retrieval services from a place outside India to a person in India other than a registered person shall file return in FORM GSTR-5A on or before the twentieth day of the month succeeding the calendar month or part thereof

65 Form and manner of submission of return by an Input Service Distributor.-

Every Input Service Distributor shall, on the basis of details contained in FORM GSTR-6A, and where required, after adding, correcting or deleting the details, furnish electronically the return in FORM GSTR-6, containing the details of tax invoices on which credit has been received and those issued under section 20, through the common portal either directly or from a Facilitation Centre notified by the Commissioner.

66 Form and manner of submission of return by a person required to deduct tax at source.-

- (1) Every registered person required to deduct tax at source under section 51 (hereafter in this rule referred to as deductor) shall furnish a return in FORM GSTR-7 electronically through the common portal either directly or from a Facilitation Centre notified by the Commissioner.
- (2) The details furnished by the deductor under sub-rule (1) shall be made available electronically to each of the suppliers in Part C of FORM GSTR-2A and FORM-GSTR- 4A on the common portal after the due date of filing of FORM GSTR-7.
- (3) The certificate referred to in sub-section (3) of section 51 shall be made available electronically to the deductee on the common portal in FORM GSTR-7A on the basis of the return furnished under sub-rule (1).

67 Form and manner of submission of statement of supplies through an ecommerce operator.-

- (1) Every electronic commerce operator required to collect tax at source under section 52 shall furnish a statement in FORM GSTR-8 electronically on the common portal, either directly or from a Facilitation Centre notified by the Commissioner, containing details of supplies effected through such operator and the amount of tax collected as required under sub-section (1) of section 52.
- (2) The details furnished by the operator under sub-rule (1) shall be made available electronically to each of the suppliers in Part C of FORM GSTR-2A on the common portal after the due date of filing of FORM GSTR-8.

68. Notice to non-filers of returns.-

A notice in FORM GSTR-3A shall be issued, electronically, to a registered person who fails to furnish return under section 39 or section 44 or section 45 or section 52.

Related provisions of the Statute

Section or Rule	Description
Section 2(94)	Definition of Registered Person
Section 2(97)	Definition of Return
Section 2(117)	Definition of Valid Return
Section 16	Eligibility and Conditions for Taking Input Tax Credit
Section 17	Apportionment of Credits and Blocked Credits
Section 22	Persons liable for registration
Section 24	Compulsory registration in certain cases
Section 37	Furnishing details of Outward supplies
Section 38	Furnishing details of inward supplies
Section 41	Claim of input tax and provisional acceptance thereof
Section 42	Matching of reversal and reclaim of input tax credit
Section 43	Matching, reversal and reclaim of reduction in output tax liability
Section 46	Notice to return defaulters
Section 47	Levy of late fee
Section 51	Tax deduction at source
Section 52	Collection of tax at source
Section 14 (IGST)	Special provision for payment of tax by a supplier of online information and database access or retrieval services.

39.1 Analysis

This section deals with filing of GST Return by persons registered under different provisions of this Act and rules made thereto.

A. Return and due dates for payment of tax and filing of return for the registered person

Section Ref – (A)	Person Liable – (B)	FORM – (C)	CGST Rule – (D)	Due date for payment of tax –(E)	Due Date for filing of return - (F)	Periodicity – (G)
39(1)	Regular Taxpayers (other than registered person covered under subsection 2, 3, 4 & 5 of Section 39)	GSTR-3 / 3B	Rule – 61	On or before the due date of filing of return – As referred in column (F)	On or before 20 th day of subsequent month	Monthly

39(2)	Composition Taxable persons	GSTR-4	Rule – 62	On or before the due date of filing of return – Ref column (F)	Within 18 th day from the end of relevant quarter	Quarterly
39(3)	Any Registered person who is liable to deduct tax at source under section 51	GSTR-7	Rule – 66	On or before the due date of filing of return – As referred in column (F)	On or before 10 th day of the subsequent month	Monthly
39(4)	Input Service Distributor (for distributing credits)	GSTR-6	Rule – 65	Not Applicable	On or before 13 th day of the succeeding month	Monthly
39(5)	Non-Resident Taxable person	GSTR-5	Rule – 63	On or before the due date of filing of return – As referred in column (F)	Within 20 days from the end of the calendar month or within 7 days after the last day of the period of registration, whichever is earlier	
39(5)	Supplier located outside taxable territory – making supply of online information and data base access or retrieval services from a place outside India to non-taxable online recipient	GSTR-5A	Rule – 64	On or before due date of filing of return – As referred in Column (F)	On or before 20 th day of the succeeding month (including part thereof)	Monthly

B. The extension of time limit for furnishing the returns

The Commissioner is empowered by sub-section (6) of section 36, for extending the due dates for furnishing the returns and basis this commissioner Central Tax / State Tax has issued Notification(s) extending due date(s) originally prescribed for filing of statement(s) / return(s) as the case may be.

Please refer 'Annexure – A' at the end of the chapter, giving details of Notification(s) extending due date(s) for various statement(s) / return(s) prescribed under the GST laws.

C. Mandatory to file returns

Every registered person covered under section 39(1) & 39(2) shall furnish a return for every tax period whether or not any supplies of goods and/or services have been effected during such tax period. In other words, the person registered as regular taxpayer (including SEZ unit or developer) and person registered as a composition taxpayer, are obliged to file "NIL RETURN" even when there is / are no transaction(s) effected by them in any tax period.

D. Rectification of error and omission

- (i) Every registered person (including ISD, person liable to deduct tax at source) who has furnished or is required to file a return in terms of this section, can on identification of any error or omission rectify the same in the tax period in which such error or omission is noticed by him.
- (ii) Rectification, resulting in additional output tax or reduction in input tax credit shall be paid / reversed and the same would be subject to interest as prescribed in section 50 of this Act.
- (iii) Such rectification of error or omission will not be allowed, when omission or incorrect particulars are discovered as a result of scrutiny, audit, inspection or enforcement activity by the tax authorities,
- (iv) Further, no rectification of any error or omission will be allowed after the due date for filing of return for the month of September or second quarter of the succeeding financial year, or the actual date of filing of relevant annual return, whichever is earlier.

E. Non-submission of previous tax period returns

A registered person will not be allowed to furnish a return for any tax period, unless returns for all previous tax periods has been furnished by him. Currently, the filing of monthly return in Form GSTR 3 is suspended and a summary return in Form GSTR 3B is required to be filed on monthly basis by every taxpayer including composition taxpayer.

Further, filing of Form GSTR 2 i.e., Statement of inward supply is also suspended for an indefinite period and therefore filing of Form GSTR 3 i.e., monthly return will not be possible. As a result, it now appears that for the period July 2017 to the date of the proposed return system is in place the assessment of returns and information furnished thereon, will be done on the basis of information furnished in Form GSTR 3B, Form GSTR 1 i.e., statement of

outward supply for supplies effected and Form GSTR 2A which is made available to the recipient of supply on the basis of details of outward supply furnished by supplier in Form GSTR 1.

Provisions relating to deduction of tax at source (section 51) and provisions of collection of tax at source (section 52), has been implemented w.e.f 1.10.2018. Form GSTR 7 is required to file by a person liable to deduct tax at source and furnishing of a statement in Form GSTR 8 is required by the person liable to collect at source in terms of GST provisions.

Return by Composition taxpayer:

Every person registered as composition taxpayer is required to furnish return on quarterly basis in Form GSTR 4 within 18 days from the end of the relevant quarter to which such return pertains to.

Please refer Annexure – A at the end of this chapter for changes in due dates and details of relevant notifications.

Return by Input Service Distributor:

Every person who is registered as an Input Service Distributor for the purpose of distributing credits relating to input services, is required to file a monthly return in Form GSTR 6 within 13 days of the succeeding month.

Please refer Annexure – A at the end of this chapter for changes in due dates and details of relevant notifications.

Valid Return:

Return furnished for any tax period will be considered as a valid return in terms of section 2(117) of the CGST Act, 2017, only when self-assessed taxes are paid in full.

Statutory provisions

40. First Return

Every registered person who has made outward supplies in the period between the date on which he became liable to registration till the date on which registration has been granted shall declare the same in the first return furnished by him after grant of registration.

40.1 Analysis

First Return – On grant of registration, a taxable person is required to file his first return. This section specifies the period for which this first return needs to be furnished. It is important to note that there is no separate form / return prescribed for first return and will have to furnish first return in regular forms such as GSTR 3B / 3 or GSTR 4 as the case may be.

Furnishing details as part of first return would apply, only when the person has effected taxable supplies between the period of date of application for registration and the actual date of grant of registration, where such registration certificate is granted effective from the date of application for registration.

The details would generally include:

Transaction to be reported	Related Period
Outward supplies	From date on which he becomes liable to get registered till the date on which registration is granted

Applicability of provisions of revised invoice:

It is important to note that, one would have to issue or raise a revised invoice, to give effect for the taxes liable to be paid under GST laws. This would be applicable only when any person, receives a certificate of registration in Form GST REG-06 bearing the date of application for registration as effective date of registration, though such registration certificate may be received at a later date (Rule 53 of CGST Rules, 2017 should be referred).

Input tax credit on purchases prior to the date of registration:

As per the provisions of Sec 18(1), Person making an application for new registration shall be entitled to claim credit of input tax held in inputs as such, inputs contained in semi-finished goods or finished goods held in stock by such person on the day immediately preceding the date from which such person is liable to obtain registration i.e., the supplies made thirty days before the date of registration if the application for registration is made on thirtieth day, from the date on which he became liable to get registered **OR** the date on which he made an application for registration, if application for registration is made immediately he became liable for registration.

Note: Input tax credit in relation to capital goods held as a fixed asset as on the above date, which will be used or is intended to be used in making taxable supply will not be available, as there is no specific provision in this regard. In such cases, person making an application for registration could effect purchases of such capital goods (if he is intending to purchase any) after receiving the said registration certificate.

Statutory provisions

41. Claim of input tax credit and provisional acceptance thereof

1. *Every registered person shall, subject to such conditions and restrictions as may be prescribed, be entitled to take the credit of eligible input tax, as self-assessed, in his return and such amount shall be credited on a provisional basis to his electronic credit ledger.*
2. *The credit referred to in sub section (1) shall be utilised only for payment of self-assessed output tax liability as per the return referred to in the said sub-section.*

41.1 Introduction

This Section relates to claim of input tax credit on self-assessment basis and its provisional acceptance thereof by the revenue.

41.2 Analysis

All registered persons shall be eligible to avail eligible input tax credit on self-assessment basis. Amount availed as input tax credit on self-assessment basis, shall be credited to his electronic credit ledger on a provisional basis and it would attain finality only after applying the procedures as prescribed under section 42 and 43 of CGST / SGST Act, 2017.

This self-assessed input tax credit can be utilised for making payment of self-assessed output tax only (other than inward supplies liable to tax under reverse charge).

Statutory provisions

42. Matching, reversal and reclaim of input tax credit

- (1) *The details of every inward supply furnished by a registered person (hereafter in this section referred to as the “recipient”) for a tax period shall, in such manner and within such time as may be prescribed, be matched-*
 - (a) *with the corresponding details of outward supply furnished by the corresponding registered person (hereafter in this section referred to as the “supplier”) in his valid return for the same tax period or any preceding tax period,*
 - (b) *with the integrated goods and services tax paid under section 3 of the Customs Tariff Act, 1975 in respect of goods imported by him, and*
 - (c) *for duplication of claims of input tax credit.*
- (2) *The claim of input tax credit in respect of invoices or debit notes relating to inward supply that match with the details of corresponding outward supply or with the integrated goods and services tax paid under section 3 of the Customs Tariff Act, 1975 in respect of goods imported by him shall be finally accepted and such acceptance shall be communicated, in such manner as may be prescribed, to the recipient.*
- (3) *Where the input tax credit claimed by a recipient in respect of an inward supply is in excess of the tax declared by the supplier for the same supply or the outward supply is not declared by the supplier in his valid returns, the discrepancy shall be communicated to both such persons in such manner as may be prescribed.*
- (4) *The duplication of claims of input tax credit shall be communicated to the recipient in such manner as may be prescribed.*
- (5) *The amount in respect of which any discrepancy is communicated under subsection (3) and which is not rectified by the supplier in his valid return for the month in which discrepancy is communicated shall be added to the output tax liability of the recipient, in such manner as may be prescribed, in his return for the month succeeding the month in which the discrepancy is communicated.*
- (6) *The amount claimed as input tax credit that is found to be in excess on account of*

duplication of claims shall be added to the output tax liability of the recipient in his return for the month in which the duplication is communicated.

- (7) *The recipient shall be eligible to reduce, from his output tax liability, the amount added under sub-section (5), if the supplier declares the details of the invoice or debit note in his valid return within the time specified in sub-section (9) of section 39.*
- (8) *A recipient in whose output tax liability any amount has been added under subsection (5) or sub-section (6), shall be liable to pay interest at the rate specified under subsection (1) of section 50 on the amount so added from the date of availing of credit till the corresponding additions are made under the said sub-sections.*
- (9) *Where any reduction in output tax liability is accepted under sub-section (7), the interest paid under sub-section (8) shall be refunded to the recipient by crediting the amount in the corresponding head of his electronic cash ledger in such manner as may be prescribed*

Provided that the amount of interest to be credited in any case shall not exceed the amount of interest paid by the supplier.

- (10) *The amount reduced from the output tax liability in contravention of the provisions of sub-section (7) shall be added to the output tax liability of the recipient in his return for the month in which such contravention takes place and such recipient shall be liable to pay interest on the amount so added at the rate specified in sub-section (3) of section 50.*

Extract of the CGST Rules, 2017

69 Matching of claim of input tax credit.-

The following details relating to the claim of input tax credit on inward supplies including imports, provisionally allowed under section 41, shall be matched under section 42 after the due date for furnishing the return in FORM GSTR-3-

- (a) *Goods and Services Tax Identification Number of the supplier;*
 (b) *Goods and Services Tax Identification Number of the recipient;*
 (c) *invoice or debit note number;*
 (d) *invoice or debit note date; and*
 (e) *tax amount:*

Provided that where the time limit for furnishing FORM GSTR-1 specified under section 37 and FORM GSTR-2 specified under section 38 has been extended, the date of matching relating to claim of input tax credit shall also be extended accordingly:

Provided further that the Commissioner may, on the recommendations of the Council, by order, extend the date of matching relating to claim of input tax credit to such date as may be specified therein.

Explanation.- For the purposes of this rule, it is hereby declared that –

- (i) *The claim of input tax credit in respect of invoices and debit notes in FORM GSTR- 2 that were accepted by the recipient on the basis of FORM GSTR-2A without amendment shall be treated as matched if the corresponding supplier has furnished a valid return;*
- (ii) *The claim of input tax credit shall be considered as matched where the amount of input tax credit claimed is equal to or less than the output tax paid on such tax invoice or debit note by the corresponding supplier.*

70 Final acceptance of input tax credit and communication thereof.--

- (1) *The final acceptance of claim of input tax credit in respect of any tax period, specified in sub-section (2) of section 42, shall be made available electronically to the registered person making such claim in FORM GST MIS-1 through the common portal.*
- (2) *The claim of input tax credit in respect of any tax period which had been communicated as mismatched but is found to be matched after rectification by the supplier or recipient shall be finally accepted and made available electronically to the person making such claim in FORM GST MIS-1 through the common portal.*

71 Communication and rectification of discrepancy in claim of input tax credit and reversal of claim of input tax credit.-

- (1) *Any discrepancy in the claim of input tax credit in respect of any tax period, specified in sub-section (3) of section 42 and the details of output tax liable to be added under sub-section (5) of the said section on account of continuation of such discrepancy, shall be made available to the recipient making such claim electronically in FORM GST MIS-1 and to the supplier electronically in FORM GST MIS-2 through the common portal on or before the last date of the month in which the matching has been carried out.*
- (2) *A supplier to whom any discrepancy is made available under sub-rule (1) may make suitable rectifications in the statement of outward supplies to be furnished for the month in which the discrepancy is made available.*
- (3) *A recipient to whom any discrepancy is made available under sub-rule (1) may make suitable rectifications in the statement of inward supplies to be furnished for the month in which the discrepancy is made available.*
- (4) *Where the discrepancy is not rectified under sub-rule (2) or sub-rule (3), an amount to the extent of discrepancy shall be added to the output tax liability of the recipient in his return to be furnished in FORM GSTR-3 for the month succeeding the month in which the discrepancy is made available.*

Explanation.- For the purposes of this rule, it is hereby declared that –

- (i) *Rectification by a supplier means adding or correcting the details of an outward*

supply in his valid return so as to match the details of corresponding inward supply declared by the recipient;

- (ii) Rectification by the recipient means deleting or correcting the details of an inward supply so as to match the details of corresponding outward supply declared by the supplier.

72 Claim of input tax credit on the same invoice more than once.-

Duplication of claims of input tax credit in the details of inward supplies shall be communicated to the registered person in FORM GST MIS-1 electronically through the common portal.

77 Refund of interest paid on reclaim of reversals.-

The interest to be refunded under sub-section (9) of section 42 or sub-section (9) of section 43 shall be claimed by the registered person in his return in FORM GSTR-3 and shall be credited to his electronic cash ledger in FORM GST PMT-05 and the amount credited shall be available for payment of any future liability towards interest or the taxable person may claim refund of the amount under section 54.

Related provisions of the Statute

Section or Rule	Description
Section 16	Eligibility and Conditions for Taking Input Tax Credit
Section 17	Apportionment of Credits and Blocked Credits
Section 37	Furnishing details of Outward supplies
Section 38	Furnishing details of inward supplies
Section 41	Claim of input tax and provisional acceptance thereof
Section 43	Matching, reversal and reclaim of reduction in output tax liability
Section 46	Notice to return defaulters
Section 47	Levy of late fee
Section 49	Payment of tax, interest, penalty and other amounts
Section 50	Interest on delayed payment of tax
Section 51	Tax deduction at source
Section 52	Collection of tax at source

42.1 Introduction

This provision relates to matching, reversal and reclaim of input tax credit. However, the provisions of section 42 shall not be applicable for the financial year 2017-18 due to deferment of filing of Form No. GSTR-2 and GSTR-3. However, the matching of input tax credit and verification of output tax liability would still be done on the basis of GSTR 1 furnished for

outward supplies and amount of credit availed by recipient apart from values as made available to him in his Form GSTR 2A, the facility of which is still available to both registered persons as well as to exchequer to ensure that there is no mismatch in output tax paid or payable / input tax credit availed or available, as the case may be.

42.2 Analysis

A. Matching, reversal and reclaim envisages the following circumstances

Situation	Remarks / Comments
All Transactions where Input credit details of recipient are matched for output tax as stated by supplier and recipient (including cases where amount of input tax credit claimed is less than the amount of output tax paid by supplier on a particular tax invoice)	The transaction is treated as matched.
Transactions where the claim of input tax credit is made more than once (i.e., Duplication of claims)	Details of such discrepancy shall be communicated to the registered person (only recipient) in FORM GST MIS 1 .
Transactions where the claim for input tax credit is higher than the output tax as declared by the supplier	<p>Details of such discrepancy shall be made available to recipient in Form GST MIS-1 and to the supplier in Form GST MIS-2 – Two possibilities:</p> <p>(a) If discrepancy is due to supplier's mistake and accepts it, can correct it in GSTR 1 of that month (results in increase in output liability in the hands of supplier).</p> <p>(b) If discrepancy is due to recipient's mistake and accepts it, can correct it in statement of inward supply for that month (results in reduction in input tax credit in the hands of recipient).</p> <p>However, if the same is not rectified by both of them, such amount will get added to output tax liability of such recipient and the said amount is payable along with applicable interest (section 50(1) of CGST Act, 2017).</p>

Transactions where the claim for input tax credit is higher than the output tax as declared by the supplier because the supplier has not furnished a particular transaction.	Same as above
--	---------------

Illustration:

The recipient of supply has filed his return for the month of July, 2018 on 20th of August, 2018. There is mismatch in the amount of input tax credit availed and amount of tax paid by the supplier on the particular tax invoice, the discrepancy will be made available to recipient in Form GST MIS-1 and to the supplier in Form GST MIS-2 by 31st day of August 2018 through the common portal.

In this case one has to understand who has committed the error and who should rectify – whether the supplier shall make rectification in their GSTR 1 to be submitted for the month of August 2018 **OR** the recipient shall make rectification in Form GSTR 2 to be submitted for the said month i.e., August 2018. In such a situation, if the supplier has committed the error and corrects it in his GSTR 1 to the said extent there will be increase in his output tax, along with applicable interest. Similarly, if the error has been committed by the recipient and he corrects it in Form GSTR 2, then to the said extent there will be reduction in the amount of input tax credit available for payment of taxes.

However, if neither the supplier nor the recipient rectifies the discrepancy, then the difference amount will get added to the output tax liability of the recipient of supply in his return in **FORM GSTR-3 / GSTR 3B as the case may be** for the month of September 2018. The said differential amount shall be payable by recipient along with applicable interest.

However, if the supplier declares the invoice or debit note in any subsequent month but before the time limit prescribed, say in the month Jan 2019, the recipient of supply can reduce the relevant tax amount from the output tax liability for the month of January 2019. Further, recipient will also be eligible for refund of interest paid earlier and the said amount will get credited to electronic cash ledger under the head of interest and can be utilised for any payment towards interest in future.

Statutory Provisions**43. Matching, reversal and reclaim of reduction in output tax liability**

- (1) *The details of every credit note relating to outward supply furnished by a registered person (hereinafter referred to in this section as the 'supplier') for a tax period shall, in such manner and within such time as may be prescribed, be matched -*
- (a) *with the corresponding reduction in the claim for input tax credit by the corresponding registered person (hereinafter referred to in this section as the 'recipient') in his valid return for the same tax period or any subsequent tax period, and*

- (b) for duplication of claims for reduction in output tax liability.
- (2) The claim for reduction in output tax liability by the supplier that matches with the corresponding reduction in the claim for input tax credit by the recipient shall be finally accepted and communicated, in the manner as may be prescribed, to the supplier.
 - (3) Where the reduction of output tax liability in respect of outward supplies exceeds the corresponding reduction in the claim for input tax credit or the corresponding credit note is not declared by the recipient in his valid returns, the discrepancy shall be communicated to both such persons in the manner as may be prescribed.
 - (4) The duplication of claims for reduction in output tax liability shall be communicated to the supplier in such manner as may be prescribed.
 - (5) The amount in respect of which any discrepancy is communicated under sub-section (3) and which is not rectified by the recipient in his valid return for the month in which discrepancy is communicated shall be added to the output tax liability of the supplier, in such manner as may be prescribed, in his return for the month succeeding the month in which the discrepancy is communicated.
 - (6) The amount in respect of any reduction in output tax liability that is found to be on account of duplication of claims shall be added to the output tax liability of the supplier in his return for the month in which such duplication is communicated.
 - (7) The supplier shall be eligible to reduce, from his output tax liability, the amount added under sub-section (5) if the recipient declares the details of the credit note in his valid return within the time specified in sub-section (9) of section 39.
 - (8) A supplier in whose output tax liability any amount has been added under subsection (5) or sub-section (6), shall be liable to pay interest at the rate specified under subsection (1) of section 50 in respect of the amount so added from the date of such claim for reduction in the output tax liability till the corresponding additions are made under the said sub-sections.
 - (9) Where any reduction in output tax liability is accepted under sub-section (7), the interest paid under sub-section (8) shall be refunded to the supplier by crediting the amount in the corresponding head of his electronic cash ledger in such manner as may be prescribed.
Provided that the amount of interest to be credited in any case shall not exceed the amount of interest paid by the recipient.
 - (10) The amount reduced from output tax liability in contravention of the provisions of sub-section (7) shall be added to the output tax liability of the supplier in his return for the month in which such contravention takes place and such supplier shall be liable to pay interest on the amount so added at the rate specified in sub-section (3) of section 50.

Extract of the CGST Rules, 2017

73 Matching of claim of reduction in the output tax liability.-

The following details relating to the claim of reduction in output tax liability shall be matched under section 43 after the due date for furnishing the return in FORM GSTR-3, namely:-

- (a) Goods and Services Tax Identification Number of the supplier;
- (b) Goods and Services Tax Identification Number of the recipient;
- (c) credit note number;
- (d) credit note date; and
- (e) tax amount:

Provided that where the time limit for furnishing FORM GSTR-1 under section 37 and FORM GSTR-2 under section 38 has been extended, the date of matching of claim of reduction in the output tax liability shall be extended accordingly:

Provided further that the Commissioner may, on the recommendations of the Council, by order, extend the date of matching relating to claim of reduction in output tax liability to such date as may be specified therein.

Explanation.- For the purposes of this rule, it is hereby declared that –

- (i) the claim of reduction in output tax liability due to issuance of credit notes in FORM GSTR-1 that were accepted by the corresponding recipient in FORM GSTR-2 without amendment shall be treated as matched if the said recipient has furnished a valid return.
- (ii) the claim of reduction in the output tax liability shall be considered as matched where the amount of output tax liability after taking into account the reduction claimed is equal to or more than the claim of input tax credit after taking into account the reduction admitted and discharged on such credit note by the corresponding recipient in his valid return.

74. Final acceptance of reduction in output tax liability and communication thereof

- (1) The final acceptance of claim of reduction in output tax liability in respect of any tax period, specified in sub-section (2) of section 43, shall be made available electronically to the person making such claim in FORM GST MIS-1 through the common portal.
- (2) The claim of reduction in output tax liability in respect of any tax period which had been communicated as mis-matched but is found to be matched after rectification by the supplier or recipient shall be finally accepted and made available electronically to the person making such claim in FORM GST MIS-1 through the common portal.

75. Communication and rectification of discrepancy in reduction in output tax liability and reversal of claim of reduction.-

- (1) Any discrepancy in claim of reduction in output tax liability, specified in sub-section (3) of section 43, and the details of output tax liability to be added under sub-section (5) of the said section on account of continuation of such discrepancy, shall be made available to the registered person making such claim electronically in FORM GST MIS- 1 and the recipient electronically in FORM GST MIS- 2 through the common portal on or before the last date of the month in which the matching has been carried out.
- (2) A supplier to whom any discrepancy is made available under sub-rule (1) may make suitable rectifications in the statement of outward supplies to be furnished for the month in which the discrepancy is made available.
- (3) A recipient to whom any discrepancy is made available under sub-rule (1) may make suitable rectifications in the statement of inward supplies to be furnished for the month in which the discrepancy is made available.
- (4) Where the discrepancy is not rectified under sub-rule (2) or sub-rule (3), an amount to the extent of discrepancy shall be added to the output tax liability of the supplier and debited to the electronic liability register and also shown in his return in FORM GSTR-3 for the month succeeding the month in which the discrepancy is made available.

Explanation.- For the purposes of this rule, it is hereby declared that –

- (i) *rectification by a supplier means deleting or correcting the details of an outward supply in his valid return so as to match the details of corresponding inward supply declared by the recipient;*
- (ii) *rectification by the recipient means adding or correcting the details of an inward supply so as to match the details of corresponding outward supply declared by the supplier.*

76 Claim of reduction in output tax liability more than once.-

The duplication of claims for reduction in output tax liability in the details of outward supplies shall be communicated to the registered person in FORM GST MIS-1 electronically through the common portal.

77 Refund of interest paid on reclaim of reversals.-

The interest to be refunded under sub-section (9) of section 42 or sub-section (9) of section 43 shall be claimed by the registered person in his return in FORM GSTR-3 and shall be credited to his electronic cash ledger in FORM GST PMT-05 and the amount credited shall be available for payment of any future liability towards interest or the taxable person may claim refund of the amount under section 54.

Related provisions of the Statute

Section or Rule	Description
Section 16	Eligibility and Conditions for Taking Input Tax Credit
Section 17	Apportionment of Credits and Blocked Credits
Section 37	Furnishing details of Outward supplies
Section 38	Furnishing details of inward supplies
Section 41	Claim of input tax and provisional acceptance thereof
Section 43	Matching, reversal and reclaim of reduction in output tax liability
Section 46	Notice to return defaulters
Section 47	Levy of late fee
Section 49	Payment of tax, interest, penalty and other amounts
Section 50	Interest on delayed payment of tax

43.1 Introduction

This provision relates to matching, reversal and reclaim of output tax liability due to discrepancy in the output tax reduced by the supplier by way of issuing credit note and corresponding reduction of input tax credit by the recipient. However, the provisions of section 43 shall not be applicable for the financial year 2017-18/18-19 as filing of details in inward supplies in Form GSTR 2 and furnishing a monthly return in Form GSTR 3 has been suspended for an indefinite period. However, still matching of reduction in output tax paid by the supplier and reduction of corresponding input tax credit (if availed earlier) will be verified by revenue authorities by adopting different modes, such as, obtaining details through jurisdiction of the recipient of supply, as the Government will not be ready to forego revenue twice viz., (i) on account of reduction in output tax liability by the supplier by way of issuing credit note; and (ii) availing of input tax credit in full, without reversing credit resulting due to credit note issued by the supplier.

The said reduction in output tax liability can also be possible on account of reduction of output tax liability by the supplier which originally was due to duplication of output tax liability, the procedure as said above would mutatis and mutandis would apply

43.2 Analysis**A. Issuance of Credit note for reduction in output tax liability:**

Where the output tax is reduced by the supplier by way of issuing a credit note, details of every such credit note issued is to be matched with the corresponding reduction in the credit by the recipient by availing lower input tax credit to that extent in the return furnished for such period in which details of credit note is made available to the recipient on the portal. For example: a supply invoice was originally issued at ₹ 150,000

was overstated by ₹ 50,000, to that effect a credit note is issued by the supplier (along with tax). This credit note is to be accepted by the recipient and should result in reduction of input tax credit to the said extent in the return furnished by the recipient of the supply.

B. Reduction in output tax liability due to duplication of output liability:

Similarly, where the supplier has paid taxes twice on a particular supply by issuing tax two tax invoices or otherwise and a credit note is issued to rectify the said error, the recipient of supply shall reduce his input tax credit (only if availed credit twice) in the tax period in which such credit note is issued by the supplier and the same is made available to the portal to the recipient. same shall also be accounted by the recipient.

Additional Comments:

All procedures as prescribed in analysis of section 42 supra and related rules thereto, would equally be applicable to this section and the reference to the same can be made to understand consequences, liability to pay interest and refund of interest paid earlier by way of credit to electronic credit ledger.

Statutory Provisions

44. Annual return

- (1) *Every registered person, other than an Input Service Distributor, a person paying tax under section 51 or section 52, a casual taxable person and a non-resident taxable person, shall furnish an annual return for every financial year electronically in such form and manner as may be prescribed on or before the thirty-first day of December following the end of such financial year.*
- (2) *Every registered person who is required to get his accounts audited in accordance with the provisions of sub-section (5) of section 35 shall furnish, electronically, the annual return under sub-section (1) along with a copy of the audited annual accounts and a reconciliation statement, reconciling the value of supplies declared in the return furnished for the financial year with the audited annual financial statement, and such other particulars as may be prescribed.*

Extract of the CGST Rules, 2017

80 Annual return.-

- (1) *Every registered person, other than those referred to in the proviso to sub-section (5) of section 35¹, other than an Input Service Distributor, a person paying tax under section 51 or section 52, a casual taxable person and a non-resident taxable person,*

¹ Inserted vide Notf no. 03/2019-CT dt. 29.01.2019 wef 01.02.2019

shall furnish an annual return as specified under sub-section (1) of section 44 electronically in FORM GSTR-9 through the common portal either directly or through a Facilitation Centre notified by the Commissioner:

Provided that a person paying tax under section 10 shall furnish the annual return in FORM GSTR-9A.

- (2) *Every electronic commerce operator required to collect tax at source under section 52 shall furnish annual statement referred to in sub-section (5) of the said section in FORM GSTR -9B.*
- (3) *Every registered person whose aggregate turnover during a financial year exceeds two crore rupees shall get his accounts audited as specified under sub-section (5) of section 35 and he shall furnish a copy of audited annual accounts and a reconciliation statement, duly certified, in FORM GSTR-9C, electronically through the common portal either directly or through a Facilitation Centre notified by the Commissioner.*

Related provisions of the Statute

Section or Rule	Description
Section 2(6)	Definition of aggregate turnover
Section 2(94)	Definition of registered person
Section 16	Eligibility and Conditions for Taking Input Tax Credit
Section 17	Apportionment of Credits and Blocked Credits
Section 37	Furnishing details of outward supplies
Section 38	Furnishing details of inward supplies
Section 39	Furnishing of returns
Section 47	Levy of late fee
Section 49	Payment of tax, interest, penalty and other amounts

44.1 Introduction

This section applies to all registered taxable person other than person registered as,

- An Input Service Distributor;
- A person liable to deduct tax under Section 51 (TDS) – Provision suspended till 30.09.2018;
- A person liable to collect tax at source under Section 52 (TCS) – Provision suspended till 30.09.2018;
- A casual tax Taxable person; and
- Non-resident taxable person.

Due date for filing Annual Return is on or before 31st December, following the end of the financial year to which the said Annual return is to be submitted.

44.2 Analysis

- (a) Every taxable person (other than those covered in the exclusion list specified supra) is required to file an annual return in **FORM GSTR-9**;
- (b) Person paying tax under composition scheme in terms of section 10 of this Act will be required to furnish annual return in **Form GSTR 9A**;

The said annual return is to be submitted electronically by persons specified in (a) and (b) supra, for every financial year on or before 31st day of December of the following the end of financial year, to which such annual return pertains to.

The same has been extended for 30th June 2019 for the Financial year 2017-18, vide Order No. 3/2018-Central Tax dated 31st Dec 2018.

Every person, whose aggregate turnover exceeds ₹ Two crores, who is required to get his accounts audited in terms of section 35(5) of this Act, shall in addition to annual return in 9, 9A as the case may be, furnish a copy of audited financial statements along with reconciliation statement in **Form GSTR 9C**, electronically.

Vide Notification No. 74/2018 – Central Tax dated 31st Dec, 2018 format of FORM GSTR 9C is notified.

Applicability of 9C

Branch 1 (Turnover)	Branch 2 (Turnover)	Whether 9C is required ?
Karnataka 100 L	Tamil Nadu 5L	Both state not required
Karnataka 199L	Assam 2 L	Both state required
Karnataka 210L	Kerala Re.1	Both state required
Karnataka 110 L + 50 L worth goods sent to Tamilnadu branch	TN 50 L	Both state required
Karnataka exclusively exempted goods 250L registration not taken	Tamil Nadu taxable goods 5L	Only in Tamil Nadu
Karnataka total sale 90L plus 50 L transfer to Mysore branch from Blr	Mysore Branch Sale 90L	Both state not required

Nature of Income 1	Nature of Income 2	Whether 9C is required ?
Rent from residential building 150L	Sale of garments 60L	Required

Sale of petrol 190L	engine oil 20L	Required
Salary received 180L	Sale of stationery 30L	Not Required
Sale of land 190L	Construction service 30L	Not Required
Sales 180L (including GST collected Rs.30 Lacs)	-	Not Required
Sales 180L with GST	Inward RCM 30L	Not Required

Statutory Provisions

45. Final return

Every registered person who is required to furnish a return under sub-section (1) of section 39 and whose registration has been cancelled shall furnish a final return within three months of the date of cancellation or date of order of cancellation, whichever is later, in such form and manner as may be prescribed.

Extract of the CGST Rules, 2017

81 Final return

Every registered person required to furnish a final return under section 45, shall furnish such return electronically in FORM GSTR-10 through the common portal either directly or through a Facilitation Centre notified by the Commissioner.

Related provisions of the Statute

Section or Rule	Description
Section 18	Availability of credit in special circumstances
Section 25	Cancellation of registration
Section 37	Furnishing details of Outward supplies
Section 38	Furnishing details of inward supplies
Section 39	Furnishing of returns
Section 47	Levy of late fee
Section 49	Payment of tax, interest, penalty and other amounts

45.1 Introduction

This section applies to all registered taxable person other than persons registered as,

- Input Service Distributor;
- A person paying tax under Section 51 (TDS) – Provision suspended till 30.06.2018;
- A person paying tax under Section 52 (TCS) – Provision suspended till 30.06.2018;

- Non-resident taxable person; and
- A person paying tax under Section (10) composition levy.

45.2 Analysis

Every registered person whose registration is cancelled (suo moto or on an application made by applicant i.e., voluntary cancellation) shall file a final return in **FORM GSTR-10** through the common portal within 3 months from the date of cancellation (in case of voluntary cancellation) or date of order of cancellation (forceful cancellation by authority), whichever is later.

Details, which shall be made available in the Final return to be furnished in Form GSTR 10, is available in CGST Rules, 2017 as latest amended on 18.04.2018 vide Notification No. 21/2018 – Central Tax dated 18.04.2018.

Most important information, is that this return would require a person whose registration is cancelled, to furnish, is as follows:

- (a) The details of value (after adjustment of credit/debit notes) and quantity of inputs held in stock, inputs contained in semi-finished or finished goods held in stock and capital goods /plant and machinery.
- (b) The details of credit availed / reversed as per the provisions of GST law and tax payable if any.
- (c) Details of amount to be payable on cancellation of registration through Electronic Cash Ledger/ Electronic Credit Ledger.
- (d) Details of interest / late fee if any payable and paid details.
- (e) State-wise summary of supplies, rate-wise, should be uploaded in Table 7 of the Form GSTR-1.

Further, it is also important to take care of the following things while furnishing final return in **Form GSTR 10**.

- (a) While providing details of inputs held in stock, inputs contained in semi-finished goods or finished goods as the case may be:
 - Where the tax invoices related to the inputs held in stock or inputs contained in semi-finished or finished goods held in stock are not available, the registered person shall estimate the value of inputs available in stock (in all three forms) for the purpose of reversal, is based on the on prevailing market price of the goods
Note: The details of stock for which invoices are not available, shall be certified by a Chartered Accountant or Cost Accountant and needs to be furnished with final return filed in Form GSTR 10.
 - In case of capital goods / plant and machinery, the value for the purpose of arriving at the value of input tax to be reversed or paid, should be the invoice value reduced

by 1/60th value per month or part thereof, from the date of invoice / purchase taking useful life as five years. For example: if the asset value was say ₹ 5 Lac and input tax credit availed on the same was ₹ 90,000 (at 18%), the said asset was put to use for say 48 months as on the date of cancellation of registration, then in such case amount of reversal would be calculated as follows:

Amount of input tax credit eligible, till the date of cancellation - ₹ 90,000 / 60 * 48 = ₹ 72,000/-

Amount of input tax credit to be reversed / paid in cash - ₹ 90,000 / 60 * 12 = ₹ 18,000

Statutory Provisions

46. Notice to return defaulters

Where a registered person fails to furnish a return under section 39 or section 44 or section 45, a notice shall be issued requiring him to furnish such return within fifteen days in such form and manner as may be prescribed.

Related provisions of the Statute:

Section or Rule	Description
Section 37	Furnishing details of outward supplies
Section 38	Furnishing details of inward supplies
Section 39	Furnishing of returns
Section 47	Levy of late fee
Section 49	Payment of tax, interest, penalty and other amounts
Section 62	Assessment of non-filers of returns

46.1 Introduction

This section applies to all registered persons who fail to furnish return under section 39 or section 44 and includes final return to be furnished in terms of section 45 of CGST Act, 2017.

46.2 Analysis

Notice to defaulter

Notice in **FORM GSTR-3A** shall be issued electronically to a registered person, who has failed to file return(s) under 39 (monthly return) and under section 44 (annual return) requiring him to file all such return(s) within 15 days from the date of serving of notice.

It is important to note that, a registered person who has failed to furnish return(s) as prescribed under section 39 including annual return under section 44, read with relevant rules thereto even after serving of notice as specified supra, the proper officer in such cases, can proceed with making a best judgement assessment on the basis of information available with

him or gathered by him, anytime within 5 years from the due date prescribed for filing annual return under section 44 of CGST Act, 2017 for that particular year, and issue an assessment order to that effect (reference to Rule 100(1) of CGST Rules, 2017 can be made).

However, where the return(s) are furnished by a person on whom such order is served, within 30 days from the date of serving of order, the order issued will stand withdrawn but the liability to pay interest for delay in payment and late fee for delay in furnishing returns would continue.

Statutory Provisions

47. Levy of late fee

- (1) Any registered person who fails to furnish the details of outward or inward supplies required under section 37 or section 38 or returns required under section 39 or section 45 by the due date shall pay a late fee of one hundred rupees for every day during which such failure continues subject to a maximum amount of five thousand rupees.
- (2) Any registered person who fails to furnish the return required under section 44 by the due date shall be liable to pay a late fee of one hundred rupees for every day during which such failure continues subject to a maximum of an amount calculated at a quarter per cent. of his turnover in the State or Union territory.

Related provisions of the Statute:

Section or Rule	Description
Section 2(112)	Definition turnover in the State or turnover in Union territory
Section 37	Furnishing details of outward supplies
Section 38	Furnishing details of inward supplies
Section 39	Furnishing of returns
Section 44	Annual return
Section 46	Notice to return defaulters
Section 49	Payment of tax, interest, penalty and other amounts

47.1 Introduction

This provision provides for late fee applicable on belated filing of statement / return(s) including belated filing of annual return.

47.2 Analysis

For late filing of return, late fee as specified below will apply:

Defaulted Return	Late fee under each CGST & SGST / UTGST Law	Revised late fee under each CGST & SGST / UTGST Law
Details of Outward Supplies (Ref: Section 37)	₹ 100 per day of delay with cap on maximum late fee of ₹ 5,000	₹ 25 per day each under CGST /SGST of delay (maximum of ₹ 5,000) In case of NIL return – ₹ 10 per day of delay maximum of ₹ 5000
Details of Inward Supplies (Ref: Section 38)	same as above	Not Applicable – As Form GSTR 2 is suspended for indefinite period
Monthly Return (Ref: Section 39) – GSTR 3 / GSTR 3B	same as above	₹ 25 per day of delay (maximum of ₹ 5,000) In case of NIL return – ₹ 10 per day of delay maximum of ₹ 5000
Details of Supplies made by Composition dealers (Ref Sec 39(2))	₹ 100 per day of delay with cap on maximum late fee of ₹ 5,000	₹ 25 per day of delay (maximum of ₹ 5,000) In case of nil return – ₹ 10 per day of delay maximum of ₹ 5000
Annual Return (Sec 44)	₹ 100 per day of delay with cap on maximum amount = 0.25% on turnover in the state / UT*	No revision
Final Return in case of cancellation of registration (Sec 45)	Same as applicable to regular return / statement	No revision

(Refer Note No. 2 at the end of the chapter, for details of Notification reducing late fee for returns to be furnished in Form GSTR 1 and GSTR 3B.

* “turnover in State” or “turnover in Union territory” means the aggregate value of all taxable supplies (excluding the value of inward supplies on which tax is payable by a person on reverse charge basis) and exempt supplies made within a State or Union territory by a taxable person, exports of goods or services or both and inter-State supplies of goods or services or both made from the State or Union territory by the said taxable person but excludes central tax, State tax, Union territory tax, integrated tax and cess.

However, by way of Notification No. 1/2018 – Central Tax dated 01.01.2018, trader will have to pay taxes at 1% (0.5% CGST and 0.5% SGST) on turnover of taxable supply of goods in the State / Union territory, by this logic the late fee should also be calculated only on value of taxable supplies for the purpose of levy of late fee on belated annual return furnished in Form 9A, by composition taxpayer being a trader. However, contradictory view is also possible to say that the restricted meaning was provided only for the purpose of collecting taxes on supply of taxable goods and not otherwise.

Statutory Provisions

48. Goods and Service tax practitioners

- (1) *The manner of approval of goods and services tax practitioners, their eligibility conditions, duties and obligations, manner of removal and other conditions relevant for their functioning shall be such as may be prescribed*
- (2) *A registered person may authorise an approved goods and services tax practitioner to furnish the details of outward supplies under section 37, the details of inward supplies under section 38 and the return under section 39 or section 44 or section 45 **and to perform such other functions**² in such manner as may be prescribed.*
- (3) *Notwithstanding anything contained in sub-section (2), the responsibility for correctness of any furnished in the return or other details filed by the goods and services tax practitioners shall continue to rest with the registered person on whose behalf such return and details are furnished.*

Extract of the CGST Rules, 2017

83 Provisions relating to a goods and services tax practitioner.-

- (1) *An application in FORM GST PCT-01 may be made electronically through the common portal either directly or through a Facilitation Centre notified by the Commissioner for enrolment as goods and services tax practitioner by any person who,*
 - (i) *is a citizen of India;*
 - (ii) *is a person of sound mind;*
 - (iii) *is not adjudicated as insolvent;*
 - (iv) *has not been convicted by a competent court;**and satisfies any of the following conditions, namely:-*
 - (a) *that he is a retired officer of the Commercial Tax Department of any State Government or of the Central Board of Indirect Taxes ³ and Customs, Department*

² Inserted vide The Central Goods & Services Amendment Act

³ Substituted for "Central Board of Excise" vide Notf no. 03/2019-CT dt. 29.01.2019 wef 01.02.2019

- of Revenue, Government of India, who, during his service under the Government, had worked in a post not lower than the rank of a Group-B gazetted officer for a period of not less than two years; or*
- (b) *that he has enrolled as a sales tax practitioner or tax return preparer under the existing law for a period of not less than five years;*
- (c) *he has passed,*
- (i) *a graduate or postgraduate degree or its equivalent examination having a degree in Commerce, Law, Banking including Higher Auditing, or Business Administration or Business Management from any Indian University established by any law for the time being in force; or*
- (ii) *a degree examination of any Foreign University recognised by any Indian University as equivalent to the degree examination mentioned in sub-clause (i); or*
- (iii) *any other examination notified by the Government, on the recommendation of the Council, for this purpose; or*
- (iv) *has passed any of the following examinations, namely:*
- (a) *final examination of the Institute of Chartered Accountants of India; or*
- (b) *final examination of the Institute of Cost Accountants of India; or*
- (c) *final examination of the Institute of Company Secretaries of India.*
- (2) *On receipt of the application referred to in sub-rule (1), the officer authorised in this behalf shall, after making such enquiry as he considers necessary, either enrol the applicant as a goods and services tax practitioner and issue a certificate to that effect in FORM GST PCT-02 or reject his application where it is found that the applicant is not qualified to be enrolled as a goods and services tax practitioner.*
- (3) *The enrolment made under sub-rule (2) shall be valid until it is cancelled*
- Provided that no person enrolled as a goods and services tax practitioner shall be eligible to remain enrolled unless he passes such examination conducted at such periods and by such authority as may be notified by the Commissioner on the recommendations of the Council:*
- Provided further that no person to whom the provisions of clause (b) of sub-rule (1) apply shall be eligible to remain enrolled unless he passes the said examination within a period of thirty months from the appointed date.*
- (4) *If any goods and services tax practitioner is found guilty of misconduct in connection with any proceedings under the Act, the authorised officer may, after giving him a notice to show cause in FORM GST PCT-03 for such misconduct and after giving him a*

reasonable opportunity of being heard, by order in FORM GST PCT -04 direct that he shall henceforth be disqualified under section 48 to function as a goods and services tax practitioner.

- (5) *Any person against whom an order under sub-rule (4) is made may, within thirty days from the date of issue of such order, appeal to the Commissioner against such order.*
- (6) *Any registered person may, at his option, authorise a goods and services tax practitioner on the common portal in FORM GST PCT-05 or, at any time, withdraw such authorisation in FORM GST PCT-05 and the goods and services tax practitioners authorised shall be allowed to undertake such tasks as indicated in the said authorisation during the period of authorisation.*
- (7) *Where a statement required to be furnished by a registered person has been furnished by the goods and services tax practitioner authorised by him, a confirmation shall be sought from the registered person over email or SMS and the statement furnished by the goods and services tax practitioner shall be made available to the registered person on the common portal:*

Provided that where the registered person fails to respond to the request for confirmation till the last date of furnishing of such statement, it shall be deemed that he has confirmed the statement furnished by the goods and services tax practitioner.

- (8) *A goods and services tax practitioner can undertake any or all of the following activities on behalf of a registered person, if so authorised by him to-*
- (a) furnish the details of outward and inward supplies;*
 - (b) furnish monthly, quarterly, annual or final return;*
 - (c) make deposit for credit into the electronic cash ledger;*
 - (d) file a claim for refund;*
 - (e) file an application for amendment or cancellation of registration;*
 - (f) furnish information for generation of e-way bill;*
 - (g) furnish details of challan in FORM GST ITC-04;*
 - (h) file an application for amendment or cancellation of enrolment under rule 58; and*
 - (i) file an intimation to pay tax under the composition scheme or withdraw from the said scheme*

Provided that where any application relating to a claim for refund or an application for amendment or cancellation of registration or where an intimation to pay tax under composition scheme or to withdraw from such scheme has been submitted by the goods and services tax practitioner authorised by the registered person, a confirmation shall be sought from the registered person and the application submitted by the said practitioner shall be made available to the registered person on the common portal and

such application shall not be further proceeded with until the registered person gives his consent to the same.]⁴

- (9) *Any registered person opting to furnish his return through a goods and services tax practitioner shall-*
- (a) *give his consent in FORM GST PCT-05 to any goods and services tax practitioner to prepare and furnish his return; and*
 - (b) *before confirming submission of any statement prepared by the goods and services tax practitioner, ensure that the facts mentioned in the return are true and correct.*
- (10) *The goods and services tax practitioner shall-*
- (a) *prepare the statements with due diligence; and*
 - (b) *affix his digital signature on the statements prepared by him or electronically verify using his credentials.*
- (11) *A goods and services tax practitioner enrolled in any other State or Union territory shall be treated as enrolled in the State or Union territory for the purposes specified in sub-rule (8).*

83A. Examination of Goods and Services Tax Practitioners. -

- (1) *Every person referred to in clause (b) of sub-rule (1) of rule 83 and who is enrolled as a goods and services tax practitioner under sub-rule (2) of the said rule, shall pass an examination as per sub-rule (3) of the said rule.*
- (2) *The National Academy of Customs, Indirect Taxes and Narcotics (hereinafter referred to as "NACIN") shall conduct the examination.*
- (3) *Frequency of examination.- The examination shall be conducted twice in a year as per the schedule of the examination published by NACIN every year on the official websites of the Board, NACIN, common portal, GST Council Secretariat and in the leading English and regional newspapers.*
- (4) *Registration for the examination and payment of fee.-*
- (i) *A person who is required to pass the examination shall register online on a website specified by NACIN.*
 - (ii) *A person who registers for the examination shall pay examination fee as specified by NACIN, and the amount for the same and the manner of its payment shall be specified by NACIN on the official websites of the Board, NACIN and common portal.*
- (5) *Examination centers.- The examination shall be held across India at the designated*

⁴ Substituted vide Notf no. 03/2019-CT dt. 29.01.2019 wef 01.02.2019

centers. The candidate shall be given an option to choose from the list of centers as provided by NACIN at the time of registration.

- (6) *Period for passing the examination and number of attempts allowed.-*
- (i) *A person enrolled as a goods and services tax practitioner in terms of sub-rule (2) of rule 83 is required to pass the examination within two years of enrolment:*
- Provided that if a person is enrolled as a goods and services tax practitioner before 1st of July 2018, he shall get one more year to pass the examination:*
- Provided further that for a goods and services tax practitioner to whom the provisions of clause (b) of sub-rule (1) of rule 83 apply, the period to pass the examination will be as specified in the second proviso of sub-rule (3) of said rule.*
- (ii) *A person required to pass the examination may avail of any number of attempts but these attempts shall be within the period as specified in clause (i).*
- (iii) *A person shall register and pay the requisite fee every time he intends to appear at the examination.*
- (iv) *In case the goods and services tax practitioner having applied for appearing in the examination is prevented from availing one or more attempts due to unforeseen circumstances such as critical illness, accident or natural calamity, he may make a request in writing to the jurisdictional Commissioner for granting him one additional attempt to pass the examination, within thirty days of conduct of the said examination. NACIN may consider such requests on merits based on recommendations of the jurisdictional Commissioner.*
- (7) *Nature of examination.-The examination shall be a Computer Based Test. It shall have one question paper consisting of Multiple Choice Questions. The pattern and syllabus are specified in Annexure-A.*
- (8) *Qualifying marks.- A person shall be required to secure fifty per cent. of the total marks.*
- (9) *Guidelines for the candidates.-*
- (i) *NACIN shall issue examination guidelines covering issues such as procedure of registration, payment of fee, nature of identity documents, provision of admit card, manner of reporting at the examination center, prohibition on possession of certain items in the examination center, procedure of making representation and the manner of its disposal.*
- (ii) *Any person who is or has been found to be indulging in unfair means or practices shall be dealt in accordance with the provisions of sub-rule (10). An illustrative list of use of unfair means or practices by a person is as under: -*
- (a) *obtaining support for his candidature by any means;*
- (b) *impersonating;*

- (c) *submitting fabricated documents;*
 - (d) *resorting to any unfair means or practices in connection with the examination or in connection with the result of the examination;*
 - (e) *found in possession of any paper, book, note or any other material, the use of which is not permitted in the examination center;*
 - (f) *communicating with others or exchanging calculators, chits, papers etc. (on which something is written);*
 - (g) *misbehaving in the examination center in any manner;*
 - (h) *tampering with the hardware and/or software deployed; and*
 - (i) *attempting to commit or, as the case may be, to abet in the commission of all or any of the acts specified in the foregoing clauses.*
- (10) *Disqualification of person using unfair means or practice.- If any person is or has been found to be indulging in use of unfair means or practices, NACIN may, after considering his representation, if any, declare him disqualified for the examination.*
- (11) *Declaration of result.- NACIN shall declare the results within one month of the conduct of examination on the official websites of the Board, NACIN, GST Council Secretariat, common portal and State Tax Department of the respective States or Union territories, if any. The results shall also be communicated to the applicants by e-mail and/or by post.*
- (12) *Handling representations.- A person not satisfied with his result may represent in writing, clearly specifying the reasons therein to NACIN or the jurisdictional Commissioner as per the procedure established by NACIN on the official websites of the Board, NACIN and common portal.*
- (13) *Power to relax.- Where the Board or State Tax Commissioner is of the opinion that it is necessary or expedient to do so, it may, on the recommendations of the Council, relax any of the provisions of this rule with respect to any class or category of persons.*
- Explanation :- For the purposes of this sub-rule, the expressions –*
- (a) *“jurisdictional Commissioner” means the Commissioner having jurisdiction over the place declared as address in the application for enrolment as the GST Practitioner in FORM GST PCT-1. It shall refer to the Commissioner of Central Tax if the enrolling authority in FORM GST PCT-1 has been selected as Centre, or the Commissioner of State Tax if the enrolling authority in FORM GST PCT-1 has been selected as State;*
 - (b) *NACIN means as notified by notification No. 24/2018-Central Tax, dated 28.05.2018.*

<i>Pattern and Syllabus of the Examination PAPER: GST Law & Procedures:</i>	
<i>Time allowed:</i>	<i>2 hours and 30 minutes</i>
<i>Number of Multiple Choice Questions:</i>	<i>100</i>
<i>Language of Questions:</i>	<i>English and Hindi</i>
<i>Maximum marks:</i>	<i>200</i>
<i>Qualifying marks:</i>	<i>100</i>
<i>No negative marking</i>	
Syllabus:	
1	The Central Goods and Services Tax Act, 2017
2	The Integrated Goods and Services Tax Act, 2017
3	All The State Goods and Services Tax Acts, 2017
4	The Union territory Goods and Services Tax Act, 2017
5	The Goods and Services Tax (Compensation to States) Act, 2017
6	The Central Goods and Services Tax Rules, 2017
7	The Integrated Goods and Services Tax Rules, 2017
8	All The State Goods and Services Tax Rules, 2017
9	Notifications, Circulars and orders issued from time to time under the said Acts and Rules. ⁵

84 Conditions for purposes of appearance.-

(1) *No person shall be eligible to attend before any authority as a goods and services tax practitioner in connection with any proceedings under the Act on behalf of any registered or un-registered person unless he has been enrolled under rule 83.*

(2) *A goods and services tax practitioner attending on behalf of a registered or an unregistered person in any proceedings under the Act before any authority shall produce before such authority, if required, a copy of the authorisation given by such person in FORM GST PCT-05.*

⁵ Inserted vide Notf no. 60/2018 – CT dt. 30.10.2018

48.1 Introduction

This provision relates to:

- Procedure to be followed in appointment / termination of specified persons as Goods and Service Tax Practitioners (GSTPs)
- Activities, which can be performed or services that can be offered by a person eligible for appointment as GST practitioner.

48.2 Analysis

The procedure as prescribed in Rule 83 of CGST Rules, 2017 supra, is to be followed to enrol as a Goods and Services Tax Practitioner (GSTP). The eligibility and disqualifications from enrolment as GSTP is also provided in the said rule.

Further, procedure and purposes for which a registered person can appoint a GSTP and duties of GSTP in relation to activities specified, is also clearly provided in the rule.

Activities, such as application for refund and cancellation of registration it is important to note that though the application is made by GSTP, approval / confirmation of the information by the registered person of information submitted by GSTP is mandatory.

A GST practitioner can undertake any or all of the following activities on behalf of a registered person, if so authorised by the registered person viz.,

- (a) furnish details of outward and inward supplies;
- (b) furnish monthly, quarterly, annual or final return;
- (c) make deposit for credit into the electronic cash ledger;
- (d) file a claim for refund; and
- (e) file an application for amendment or cancellation of registration.

Notes to the Chapter:

Note 1. Filing of GSTR-2 and GSTR-3 have been suspended for indefinite period. As such, all provisions relating to filing of details of inward supply in GSTR-2, monthly return in GSTR-3, matching provisions specified in section 42 and section 43 shall not be applicable till the date government prescribes the new model of returns and issue notification(s) in this regard.

Note 2. Late fees for failure to file GSTR-3B has been waived for the months of July 2017, August 2017 and September 2017. From October 2017, the late fees has been reduced to twenty five rupees per day (both under CGST, SGST / UTGST) and where the central tax payable is nil, the late fee is restricted to ten rupees per day (both under CGST and SGST / UTGST / IGST). Refer table in Para 47.2 supra.

Note 3. Non-filing of GST Returns for two consecutive tax periods/ months would debar the taxpayer from generating any e-way bill

In a bid to force non-compliant businesses to file returns regularly, the finance ministry has barred e-way bill generation while transporting consignment if the supplier or recipient of the cargo has not furnished returns for

- two consecutive tax periods under GST in case of Composition Tax Payer
- a consecutive period of two months, in case of person other than Composition Tax Payer

Annexure A

Revised / Applicable due dates:

Type of Return:	Tax period	Due date	Reference
GSTR - 1 (Quarterly)	July 2017 to Sep 2017	31.10.2018	Notification No. 43/2018, dated 10 th Sep 2018
	Oct 2017 to Dec 2017	31.10.2018	
	Jan 2018 to Mar 2018	31.10.2018	
	Apr 2018 to June 2018	31.10.2018	
	July 2018 to Sep 2018	31.10.2019	Notification No. 43/2018, dated 10 th Sep 2018, whose principal place of business is not in Srikakulam district in the state of Andhra Pradesh, In the State of Kerala & in Mahe in the UT of Puducherry & in Kodagu district in the State of Karnataka
	July 2018 to Sep 2018	30.11.2018	Notification No. 64/2018 - Central Tax dated 29.11.2018. Whose principal place of business is in Srikakulam district in the state of Andhra Pradesh
	July 2018 to Sep 2018	15 th Nov 2018	Notification No. 43/2018, dated 10 th Sep 2018, registered persons in the State of Kerala, in Mahe in the UT of Puducherry & in Kodagu district in the State of Karnataka
	July 2017 to Sep 2018	31 st Dec 2018	Notification No. 43/2018,

			dated 10 th Sep 2018 For the taxpayers who have obtained Goods and Services Tax Identification Number (GSTIN) in terms of notification No. 31/2018 Newly Migrated
	Oct 2018 to Dec 2018	31.01.2019	Notification No. 43/2018, dated 10th Sep 2018
	Jan 2019 to March 2019	30.04.2019	Notification No. 43/2018, dated 10th Sep 2018
GSTR - 1 (Monthly)	July 2017 to June 18	31.10.2018	Notification No.44/2018 - Central Tax dated 10.09.2018
	July 18 to Aug 18	31.10.2018	Notification No.44/2018 - Central Tax dated 10.09.2018, Not registered persons in the State of Kerala, Not having principal place of business is in Kodagu district in the State of Karnataka; and registered persons whose principal place of business is in Mahe in the Union territory of Puducherry
	Sep-18	31.10.2018	Notification No.44/2018 - Central Tax dated 10.09.2018 ,whose principal place of business is not in Srikakulam district in the state of Andhra Pradesh
	Sep-18	30-11-2018	Notification No. 63/2018 - Central Tax dated 29.11.2018. Whose principal place of business is in Srikakulam district in the state of Andhra Pradesh
	Oct-18	11.11.2018	Notification No.44/2018 - Central Tax dated 10.09.2018 , whose principal place of

			business is not in Srikakulam district in the state of Andhra Pradesh & some districts of Tamil Nadu
Oct-18	30-11-2018		Notification No. 63/2018 - Central Tax dated 29.11.2018. Whose principal place of business is in Srikakulam district in the state of Andhra Pradesh
Oct-18	20-12-2018		Notification No. 63/2018 - Central Tax dated 29.11.2018. Whose principal place of business is in Cuddalore, Thiruvarur, Pudukottai, Dindigul, Nagapatinam, Theni, Thanjavur, Sivagangai, Tiruchirappalli, Karur and Ramanathapuram in the State of Tamil Nadu
Nov-18	11.12.2018		Notification No.44/2018 - Central Tax dated 10.09.2018
Dec-18	11.01.2018		Notification No.44/2018 - Central Tax dated 10.09.2018
July 17 to Nov 18	31 st Dec 2018		For the taxpayers who have obtained Goods and Services Tax Identification Number (GSTIN) in terms of notification No. 31/2018 Newly Migrated.
Jan-18	11.02.2019		Notification No.44/2018 - Central Tax dated 10.09.2018
Feb-18	11.03.2019		Notification No.44/2018 - Central Tax dated 10.09.2018
March-18	11.04.2019		Notification No.44/2018 - Central Tax dated 10.09.2018

GSTR - 3B	Jul-17	25/28.08.2017	Notification No. 23 & 24/2017 - Central Tax dated 17.08.2017 and 21.08.2017 respectively
	Aug-17	20.09.2017	
	Sep-17	20.10.2017	Notification No.35/2017 Central Tax dated 15.09.2017 &
	Oct-17	20.11.2017	
	Nov-17	20.12.2017	
	Dec-17	22.01.2018	Notification No. 2/2018 - Central Tax dated 20.01.2018 (for January only)
	Jan-18	20.02.2018	Notification No. 56/2017 - Central Tax dated 15.11.2017 &
	Feb-18	20.03.2018	
	Mar-18	20.04.2018	Notification No.16/2018 - Central Tax dated 23.03.2018
	Apr-18	20.05.2018	
	May-18	20.06.2018	
	Jun-18	20.07.2018	
	July -18	24.08.2018	Notification 35/2018 Central tax dated 21 st Aug 2018 person other than registered persons in the State of Kerala, registered persons whose principal place of business is in Kodagu district in the State of Karnataka; and in Mahe in the Union territory of Puducherry
	July -18	05-10-2018	registered persons in the State of Kerala, registered persons whose principal place of business is in Kodagu district in the State of Karnataka; and in Mahe in the Union territory of Puducherry
Aug-18	20.09.2018	Notification 34/2018 Central tax dated 10 th Aug 2018 person other than registered persons in the State of Kerala, registered persons whose principal place of	

			business is in Kodagu district in the State of Karnataka; and in Mahe in the Union territory of Puducherry
Aug-18	10-10-2018		registered persons in the State of Kerala, registered persons whose principal place of business is in Kodagu district in the State of Karnataka; and in Mahe in the Union territory of Puducherry
Sep-18	25.10.2018		Notification 55/2018 Central tax dated 21 st Oct 2018, whose principal place of business is not in Srikakulam district in the state of Andhra Pradesh
Sep-18	30-11-2018		Notification No. 62/2018 - Central Tax dated 29.11.2018. Whose principal place of business is in Srikakulam district in the state of Andhra Pradesh
Oct-18	20.11.2018		Notification 34/2018 Central tax dated 10 th Aug 2018, whose principal place of business is not in Srikakulam district in the state of Andhra Pradesh & some districts of Tamil Nadu
Oct-18	30-11-2018		Notification No. 62/2018 - Central Tax dated 29.11.2018. Whose principal place of business is in Srikakulam district in the state of Andhra Pradesh
Oct-18	20-12-2018		Notification No. 62/2018 - Central Tax dated 29.11.2018. Whose principal

			place of business is in Cuddalore, Thiruvarur, Pudukottai, Dindigul, Nagapatinam, Theni, Thanjavur, Sivagangai, Tiruchirappalli, Karur and Ramanathapuram in the State of Tamil Nadu
	Nov-18	20.12.2018	Notification 34/2018 Central tax dated 10 th Aug 2018
	Dec-18	20.01.2018	Notification 34/2018 Central tax dated 10 th Aug 2018
	July 17 to Nov 18	31 st Dec 2018	Taxpayers who have obtained Goods and Services Tax Identification Number (GSTIN) in terms of notification No. 31/2018 (newly migrated persons)
	Jan-18	20.02.2018	Notification 34/2018 Central tax dated 10 th Aug 2018
	Feb-18	20.03.2018	Notification 34/2018 Central tax dated 10 th Aug 2018
	March-18	20.04.2018	Notification 34/2018 Central tax dated 10 th Aug 2018
GSTR – 4	July 2017 to Sept 2017	24.12.2017	Notification No. 59/2017 - Central Tax dated 15.11.2017
	Oct 2017 to Dec 2017	18.01.2018	No Notification issued and date as per law continues
	Jan 2018 to Mar 2018	18.04.2018	No extension as of now [as per section 39(2) due date is provided]
	Apr 2018 to June 2018	18.07.2018	
	July 18 to Sep 2018	18.10.2018	No Notification issued and date as per law continues, whose principal place of business is not in Srikakulam district in the state of Andhra Pradesh
	July 18 to Sep 2018	30.11.2018	Notification No. 65/2018 -

			Central Tax dated 29.11.2018. Whose principal place of business is in Srikakulam district in the state of Andhra Pradesh
	Oct 18 to Dec 2018	18.01.2019	No Notification issued and date as per law continues
	Jan 19 to Mar 2019	18.04.2019	No Notification issued and date as per law continues
GSTR 6	July 2017 to Aug 2018	30.09.2018	Notification No. 30/2018 – Central Tax dated 30.07.2018
GSTR 7	Oct 2017 to Dec 2018	31-01-2019	Notification No. 66/2018 – Central Tax dated 29.11.2018

Chapter 11

Payment of Tax

Sections	Rules
49. Payment of tax, interest, penalty and other amounts	85. Electronic Liability Register
49A. Utilisation of input tax credit subject to certain conditions.	86. Electronic Credit Ledger
49B. Order of utilisation of input tax credit.	87. Electronic Cash Ledger
50. Interest on delayed payment of tax	88. Identification number for each transaction
51. Tax deduction at source	
52. Collection of tax at source	
53. Transfer of input tax credit	

Statutory provisions- Effective from 1st July, 2017 to 31st January, 2019

<p>49 Payment of Tax, Interest, Penalty and other Amounts</p> <p>(1) <i>Every deposit made towards tax, interest, penalty, fee or any other amount by a person by internet banking or by using credit or debit cards or National Electronic Fund Transfer or Real Time Gross Settlement or by such other mode and subject to such conditions and restrictions as may be prescribed, shall be credited to the electronic cash ledger of such person to be maintained in such manner as may be prescribed.</i></p> <p>(2) <i>The input tax credit as self-assessed in the return of a registered person shall be credited to his electronic credit ledger, in accordance with section 41; to be maintained in such manner as may be prescribed.</i></p> <p>(3) <i>The amount available in the electronic cash ledger may be used for making any payment towards tax, interest, penalty, fees or any other amount payable under the provisions of this Act or the rules made thereunder in such manner and subject to such conditions and within such time as may be prescribed.</i></p> <p>(4) <i>The amount available in the electronic credit ledger may be used for making any payment towards output tax under this Act or under the Integrated Goods and Services Tax Act in such manner and subject to such conditions and within such time as may be prescribed.</i></p> <p>(5) <i>The amount of input tax credit available in the electronic credit ledger of the registered person on account of-</i></p>

- (a) *integrated tax shall first be utilised towards payment of integrated tax and the amount remaining, if any, may be utilised towards the payment of central tax and State tax, or as the case may be, Union territory tax, in that order;*
 - (b) *the central tax shall first be utilised towards payment of central tax and the amount remaining, if any, may be utilised towards the payment of integrated tax;*
 - (c) *the State tax shall first be utilised towards payment of State tax and the amount remaining, if any, may be utilised towards payment of integrated tax*
 - (d) *the Union territory tax shall first be utilised towards payment of Union territory tax and the amount remaining, if any, may be utilised towards payment of integrated tax;*
 - (e) *the central tax shall not be utilised towards payment of State tax or Union territory tax; and*
 - (f) *the State tax or Union territory tax shall not be utilised towards payment of central tax.*
- (6) *The balance in the electronic cash ledger or electronic credit ledger after payment of tax, interest, penalty, fee or any other amount payable under this Act or the rules made thereunder may be refunded in accordance with the provisions of section 54.*
- (7) *All liabilities of a taxable person under this Act shall be recorded and maintained in an electronic liability register in such manner as may be prescribed.*
- (8) *Every taxable person shall discharge his tax and other dues under this Act or the rules made thereunder in the following order, namely:*
- (a) *self-assessed tax, and other dues related to returns of previous tax periods;*
 - (b) *self-assessed tax, and other dues related to the return of the current tax period;*
 - (c) *any other amount payable under this Act or the rules made thereunder including the demand determined under Section 73 or 74.*
- (9) *Every person who has paid the tax on goods or services or both under this Act shall, unless the contrary is proved by him, be deemed to have passed on the full incidence of such tax to the recipient of such goods or services or both.*
- Explanation. 1- For the purposes of this section,*
- (a) *the date of credit to the account of the Government in the authorised bank shall be deemed to be the date of deposit in the electronic cash ledger;*
 - (b) *the expression*
 - (i) *“tax dues” means the tax payable under this Act and does not include interest, fee and penalty; and*
 - (ii) *“other dues” means interest, penalty, fee or any other amount payable under this Act or the rules made thereunder.*

Statutory Provisions- Effective from 1st February, 2019**49 Payment of Tax, Interest, Penalty and other Amounts**

- (1) *Every deposit made towards tax, interest, penalty, fee or any other amount by a person by internet banking or by using credit or debit cards or National Electronic Fund Transfer or Real Time Gross Settlement or by such other mode and subject to such conditions and restrictions as may be prescribed, shall be credited to the electronic cash ledger of such person to be maintained in such manner as may be prescribed.*
- (2) *The input tax credit as self-assessed in the return of a registered person shall be credited to his electronic credit ledger, in accordance with section 41 or section 43; to be maintained in such manner as may be prescribed.*
- (3) *The amount available in the electronic cash ledger may be used for making any payment towards tax, interest, penalty, fees or any other amount payable under the provisions of this Act or the rules made thereunder in such manner and subject to such conditions and within such time as may be prescribed.*
- (4) *The amount available in the electronic credit ledger may be used for making any payment towards output tax under this Act or under the Integrated Goods and Services Tax Act in such manner and subject to such conditions and within such time as may be prescribed.*
- (5) *The amount of input tax credit available in the electronic credit ledger of the registered person on account of-*
 - (a) *integrated tax shall first be utilised towards payment of integrated tax and the amount remaining, if any, may be utilised towards the payment of central tax and State tax, or as the case may be, Union territory tax, in that order;*
 - (b) *the central tax shall first be utilised towards payment of central tax and the amount remaining, if any, may be utilised towards the payment of integrated tax;*
 - (c) *the State tax shall first be utilised towards payment of State tax and the amount remaining, if any, may be utilised towards payment of integrated tax*

Provided that the input tax credit on account of State tax shall be utilised towards payment of integrated tax only where the balance of the input tax credit on account of central tax is not available for payment of integrated tax;
 - (d) *the Union territory tax shall first be utilised towards payment of Union territory tax and the amount remaining, if any, may be utilised towards payment of integrated tax;*

Provided that the input tax credit on account of Union territory tax shall be utilised towards payment of integrated tax only where the balance of the input tax credit on account of central tax is not available for payment of integrated tax;

- (e) *the central tax shall not be utilised towards payment of State tax or Union territory tax; and*
- (f) *the State tax or Union territory tax shall not be utilised towards payment of central tax.*
- (6) *The balance in the electronic cash ledger or electronic credit ledger after payment of tax, interest, penalty, fee or any other amount payable under this Act or the rules made thereunder may be refunded in accordance with the provisions of section 54.*
- (7) *All liabilities of a taxable person under this Act shall be recorded and maintained in an electronic liability register in such manner as may be prescribed.*
- (8) *Every taxable person shall discharge his tax and other dues under this Act or the rules made thereunder in the following order, namely:*
- (a) *self-assessed tax, and other dues related to returns of previous tax periods;*
- (b) *self-assessed tax, and other dues related to the return of the current tax period;*
- (c) *any other amount payable under this Act or the rules made thereunder including the demand determined under Section 73 or 74.*
- (9) *Every person who has paid the tax on goods or services or both under this Act shall, unless the contrary is proved by him, be deemed to have passed on the full incidence of such tax to the recipient of such goods or services or both.*
- Explanation.1- For the purposes of this section,*
- (a) *the date of credit to the account of the Government in the authorised bank shall be deemed to be the date of deposit in the electronic cash ledger;*
- (b) *the expression*
- (i) *“tax dues” means the tax payable under this Act and does not include interest, fee and penalty; and*
- (ii) *“other dues” means interest, penalty, fee or any other amount payable under this Act or the rules made thereunder.*

Extract of the CGST Rules, 2017

85 Electronic Liability Register

- (1) *The electronic liability register specified under subsection(7) of section 49 shall be maintained in FORM GST PMT-01 for each person liable to pay tax, interest, penalty, late fee or any other amount on the common portal and all amounts payable by him shall be debited to the said register.*
- (2) *The electronic liability register of the person shall be debited by-*
- (a) *the amount payable towards tax, interest, late fee or any other amount payable as per the return furnished by the said person;*
- (b) *the amount of tax, interest, penalty or any other amount payable as determined*

- by a proper officer in pursuance of any proceedings under the Act or as ascertained by the said person;
- (c) the amount of tax and interest payable as a result of mismatch under section 42 or section 43 or section 50; or
- (d) any amount of interest that may accrue from time to time.
- (3) Subject to the provisions of section 49, section 49A and section 49B, payment of every liability by a registered person as per his return shall be made by debiting the electronic credit ledger maintained as per rule 86 or the electronic cash ledger maintained as per rule 87 and the electronic liability register shall be credited accordingly.
- (4) The amount deducted under section 51, or the amount collected under section 52, or the amount payable on reverse charge basis, or the amount payable under section 10, any amount payable towards interest, penalty, fee or any other amount under the Act shall be paid by debiting the electronic cash ledger maintained as per rule 87 and the electronic liability register shall be credited accordingly.
- (5) Any amount of demand debited in the electronic liability register shall stand reduced to the extent of relief given by the appellate authority or Appellate Tribunal or court and the electronic tax liability register shall be credited accordingly.
- (6) The amount of penalty imposed or liable to be imposed shall stand reduced partly or fully, as the case may be, if the taxable person makes the payment of tax, interest and penalty specified in the show cause notice or demand order and the electronic liability register shall be credited accordingly.
- (7) A registered person shall, upon noticing any discrepancy in his electronic liability ledger, communicate the same to the officer exercising jurisdiction in the matter, through the common portal in FORM GST PMT-04.

86 Electronic Credit Ledger

- (1) The electronic credit ledger shall be maintained in FORM GST PMT-02 for each registered person eligible for input tax credit under the Act on the common portal and every claim of input tax credit under the Act shall be credited to the said ledger.
- (2) The electronic credit ledger shall be debited to the extent of discharge of any liability in accordance with the provisions of section 49 or section 49A or section 49B.
- (3) Where a registered person has claimed refund of any unutilized amount from the electronic credit ledger in accordance with the provisions of section 54, the amount to the extent of the claim shall be debited in the said ledger.
- (4) If the refund so filed is rejected, either fully or partly, the amount debited under sub rule (3), to the extent of rejection, shall be re-credited to the electronic credit ledger by the proper officer by an order made in FORM GST PMT-03.
- (5) Save as provided in the provisions of this Chapter, no entry shall be made directly in the electronic credit ledger under any circumstance.

- (6) A registered person shall, upon noticing any discrepancy in his electronic credit ledger, communicate the same to the officer exercising jurisdiction in the matter, through the common portal in FORM GST PMT-04.

Explanation.— For the purposes of this rule, it is hereby clarified that a refund shall be deemed to be rejected, if the appeal is finally rejected or if the claimant gives an undertaking to the proper officer that he shall not file an appeal.

87 Electronic Cash Ledger

- (1) The electronic cash ledger under sub-section (1) of section 49 shall be maintained FORM GST PMT-05 for each person, liable to pay tax, interest, penalty, late fee or any other amount, on the common portal for crediting the amount deposited and debiting the payment therefrom towards tax, interest, penalty, fee or any other amount.

- (2) Any person, or a person on his behalf, shall generate a challan in FORM GST PMT-06 on the common portal and enter the details of the amount to be deposited by him towards tax, interest, penalty, fees or any other amount:

Provided that the challan in FORM GST PMT-06 generated at the common portal shall be valid for a period of fifteen days.

Provided further that a person supplying online information and database access or retrieval services from a place outside India to a non-taxable online recipient referred to in section 14 of the Integrated Goods and Services Tax Act, 2017 (13 of 2017) may also do so through the Board's payment system namely, Electronic Accounting System in Excise and Service Tax from the date to be notified by the Board.

- (3) The deposit under sub-rule (2) shall be made through any of the following modes namely:-

- (i) Internet Banking through authorised banks;
- (ii) Credit card or Debit card through the authorised bank;
- (iii) National Electronic Fund Transfer or Real Time Gross Settlement from an bank;
or
- (iv) Over the Counter payment through authorised banks for deposits up to ten thousand rupees per challan per tax period, by cash, cheque or demand draft:

Provided that the restriction for deposit up to ten thousand rupees per challan in case of an Over the Counter payment shall not apply to deposit to be made by –

- (a) Government Departments or any other deposit to be made by persons as maybe notified by the Commissioner in this behalf;
- (b) Proper officer or any other officer authorised to recover outstanding due from any person, whether registered or not, including recovery made through attachment or sale of movable or immovable properties;
- (c) Proper officer or any other officer authorised for the amounts collected by way of cash, cheque or demand draft during any investigation or enforcement activity or

any ad hoc deposit:

Provided further that a person supplying online information and database access or retrieval services from a place outside India to a non-taxable online recipient referred to in section 14 of the Integrated Goods and Services Tax Act, 2017 (13 of 2017) may also make the deposit under sub-rule (2) through international money transfer through Society for Worldwide Interbank Financial Telecommunication payment network, from the date to be notified by the Board

Explanation.– For the purposes of this sub-rule, it is hereby clarified that for making payment of any amount indicated in the challan, the commission, if any, payable in respect of such payment shall be borne by the person making such payment.

- (4) Any payment required to be made by a person who is not registered under the Act, shall be made on the basis of a temporary identification number generated through the common portal.*
- (5) Where the payment is made by way of National Electronic Fund Transfer or Real Time Gross Settlement mode from any bank, the mandate form shall be generated along with the challan on the common portal and the same shall be submitted to the bank from where the payment is to be made:

Provided that the mandate form shall be valid for a period of fifteen days from the date of generation of challan*
- (6) On successful credit of the amount to the concerned government account maintained in the authorised bank, a Challan Identification Number shall be generated by the collecting bank and the same shall be indicated in the challan.*
- (7) On receipt of the Challan Identification Number from the collecting bank, the said amount shall be credited to the electronic cash ledger of the person on whose behalf the deposit has been made and the common portal shall make available a receipt to this effect.*
- (8) Where the bank account of the person concerned, or the person making the deposit on his behalf, is debited but no Challan Identification Number is generated or generated but not communicated to the common portal, the said person may represent electronically in FORM GST PMT-07 through the common portal to the bank or electronic gateway through which the deposit was initiated.*
- (9) Any amount deducted under section 51 or collected under section 52 and claimed in FORM GSTR-02 by the registered taxable person from whom the said amount was deducted or, as the case may be, collected shall be credited to his electronic cash ledger in accordance with the provisions of rule 87.*
- (10) Where a person has claimed refund of any amount from the electronic cash ledger, the said amount shall be debited to the electronic cash ledger.*

(11) If the refund so claimed is rejected, either fully or partly, the amount debited under sub-rule (10), to the extent of rejection, shall be credited to the electronic cash ledger by the proper officer by an order made in FORM GST PMT-03.

(12) A registered person shall, upon noticing any discrepancy in his electronic cash ledger, communicate the same to the officer exercising jurisdiction in the matter, through the common portal in FORM GST PMT-04.

Explanation 1.—The refund shall be deemed to be rejected if the appeal is finally rejected.

Explanation 2.—For the purposes of this rule, it is hereby clarified that a refund shall be deemed to be rejected, if the appeal is finally rejected or if the claimant gives an undertaking to the proper officer that he shall not file an appeal.

Relevant circulars, notifications, clarifications issued by Government:

1. Notification No. 13/2017 – Central Tax dated 28.06.2017 – Prescribing rate of interest payable for delay in payment of tax / issue of refunds.
2. Notification No. 66/2017 – Central Tax dated 15.11.2017 – confirming, no payment of tax on advances in case of supply of goods.

Related provisions of the Statute

Section or Rule	Description
Section 2(43)	Electronic Cash Ledger
Section 2(46)	Electronic Credit Ledger
Section 2(62)	Definition of Input Tax
Section 2(82)	Definition of Output Tax
Section 2(94)	Definition of Registered Person
Section 2(97)	Definition of Return
Section 2(117)	Definition of Valid Return
Section 9	Levy and Collection
Section 10 (IGST)	Place of supply of goods other than supply of goods imported into or exported from India
Section 11 (IGST)	Place of supply of goods imported into or exported from India
Section 12 (IGST)	Place of supply of services where location of supplier and recipient is in India
Section 13 (IGST)	Place of supply of services where location of supplier or location of recipient is outside India

Section 16	Eligibility and Conditions for Taking Input Tax Credit
Section 17	Apportionment of Credits and Blocked Credits
Section 39	Furnishing of Returns
Section 41	Claim of Input Tax Credit and Provisional Acceptance thereof
Section 50	Interest on Delayed Payment of Tax
Section 51	Tax deduction at source
Section 54	Refund of tax
Section 77	Tax Wrongfully Collected and Paid to Central or State Government
Section 19 (IGST)	Tax Wrongfully Collected and Paid to Central or State Government

49.1 Introduction

This section provides for the following:

1. Methodology or mode of payment of tax, interest, penalty, fee or any other amount by a taxable person,
2. This section prescribes maintenance of three kinds of ledgers by the taxable person.
 - (a) Electronic Cash Ledger;
 - (b) Electronic Input Tax Credit Ledger or Electronic Credit Ledger;
 - (c) Electronic Tax Liability Register.
3. The section further provides for availability of credit in the cash ledger or the credit ledger depending on the payment made by the taxable person.
4. It provides for utilization of credit and prescribes the method of cross utilization of credit.
5. Transfer of input tax credit from CGST to IGST account when CGST is utilized for payment of IGST; similar provisions are enacted in SGST Act and UTGST Act as well.

49.2 Analysis

A. ELECTRONIC CASH LEDGER:

The provisions regarding Electronic Cash Ledger and amounts credited into this ledger are dealt with in sub-Section (1) & (3) of Section 49 of the CGST Act.

1. Deposit of tax, interest, penalty, fee or any other amount by a taxable person can be made by the following modes: -
 - Internet Banking

- Credit /Debit cards
 - National Electronic Fund Transfer (NEFT)
 - Real Time Gross Settlement (RTGS)
 - Over the Counter payment (OTC) through authorized banks for deposits up to ten thousand rupees per challan per tax period, by cash, cheque or demand draft. This amount restriction is not applicable to remittances by
 - Government Departments
 - Proper Officer or any other Officer recovering outstanding dues or during any investigation or enforcement activity or ad hoc deposit
 - International money transfer through Society for Worldwide Interbank Financial Telecommunication payment network- for person supplying online information and database access or retrieval services from a place outside India to a non-taxable online recipient
 - Any other mode as may be prescribed.
2. The 'deposit' made by one of the above-mentioned modes will be credited to the Electronic Cash Ledger of the taxable person. This ledger shall be maintained in **FORM GST PMT-05**
 3. Any person, or a person on his behalf, shall generate a challan in **FORM GST PMT-06** on the Common Portal and enter the details of the amount to be deposited by him towards tax, interest, penalty, fees or any other amount
 4. The challan in **FORM GST PMT-06** generated on the Common Portal shall be valid for a period of fifteen days
 5. A person supplying online information and database access or retrieval services from a place outside India to a non-taxable online recipient may also do so through the Boards payment system namely, Electronic Accounting System in Excise and Service Tax from the date to be notified by the Board.
 6. Any payment required to be made by a person who is not registered under the Act, shall be made on the basis of a temporary identification number generated through the Common Portal.
 7. Date of credit into the account of the Government is deemed to be the **date of deposit** (not the actual date of debit to the account of the taxable person).
 8. On successful credit of the amount to the concerned government account maintained in the authorised bank, a Challan Identification Number (CIN) will be generated by the collecting Bank and the same shall be indicated in the challan.
 9. Where the bank account of the person concerned, or the person making the deposit on

his behalf, is debited but no Challan Identification Number (CIN) is generated or generated but not communicated to the Common Portal, the said person may represent electronically in **FORM GST PMT-07** through the Common Portal to the Bank or electronic gateway through which the deposit was initiated.

10. The amount available in the Electronic Cash Ledger may be used for making any payment towards tax, interest, penalty, fees or any other amount payable for the same head under the provisions of the Act or Rules.
11. Any payment made towards respective Account Heads shall only be utilized for offset of liability of that head of account. For example, if IGST is paid through a Challan, then this cash balance against IGST in the cash ledger shall only be utilized for payment of IGST.
12. Any amount deducted under section 51 (TDS by Central / State Government or local authority or Government Agencies) or collected under section 52 (TCS by e-commerce operator) and claimed in **FORM GSTR-02** by the registered taxable person from whom the said amount was deducted or, as the case may be, collected shall be credited to his electronic cash ledger.
13. Concept of unjust enrichment always works together with a presumption provision. Section 49(9) contains such a presumption that tax is presumed to have been passed on. Please note that is a rebuttable presumption as it is not an assumption made in the law.

B. ELECTRONIC CREDIT LEDGER

1. Sub Section (2) of Section 49 of the CGST Act provides that the self-assessed Input Tax Credit as per return filed by a taxable person shall be credited to its **Electronic Credit Ledger**.
2. This ledger shall be maintained in **FORM GST PMT-02** for each registered person eligible for input tax credit under the Act on the Common Portal and every claim of input tax credit under the Act shall be credited to the said Ledger.
3. The Electronic credit ledger may include the following:
 - Transitional credit of Excise and Service tax as CGST Credit and State VAT credit as SGST Credit.
 - ITC on inward supplies (including eligible capital goods) from registered tax payers.
 - ITC available based on distribution from input services distributor (ISD).
 - ITC on Input of Stock held/ semi-finished goods or finished goods held in stock on the day immediately preceding the date from which the taxpayer became liable to pay tax provided he applies for registration within 30 days from the date

of his liability.

- Permissible ITC on inputs held in stock and inputs contained in semi- finished or finished goods held in stock on the day of conversion from composition scheme to regular tax scheme.
- ITC eligible on payment made on reverse charge basis

The above list is illustrative and not exhaustive viz., credit transfers to a recipient in cases of mergers, amalgamations etc.,.

4. A registered person shall, upon noticing any discrepancy in his electronic credit ledger, is to communicate the same to the officer exercising jurisdiction in the matter, through the Common Portal in **FORM GST PMT-04**

COMMON POINTS FOR ELECTRONIC CASH & CREDIT LEDGER

1. Where a person has claimed refund of any amount from the electronic cash or credit ledger, the said amount shall be debited to the electronic cash or credit ledger
2. If the refund so claimed is rejected, either fully or partly, the amount debited earlier, to the extent of rejection, shall be credited to the electronic cash or credit ledger by the proper officer by an order made in **FORM GST PMT-03**.

MANNER OF UTILISATION OF ITC AND CROSS UTILIZATION

1. The amount available in the electronic credit ledger may be utilized for effecting payment towards output tax payable under the Act or Rules. The manner of utilization, conditions and time lines is specifically prescribed.
2. The **Electronic Credit Ledger** has the following (cross) credit utilization arrangement

Credit of:	Allowed for Payment of		
	IGST	CGST	SGST
IGST	✓ (1)	✓ (2)	✓ (3)
CGST	✓ (2)	✓ (1)	
SGST	✓ (2)		✓ (1)

3. The proviso to sub-section 5 of section 49 shall be inserted vide the CGST (Amendment) Act, 2018 (No.31 of 2018) published in the Official Gazette on 30th August, 2018 read as “ *Provided that the input tax credit on account of State tax / union territory tax shall be utilized towards payment of integrated tax only where the balance of the input tax credit on account of central tax is not available for payment of integrated tax;*”
4. Hence cross-utilization of credit is available meaning it can be effected only **in that**

order. The important restriction is that the CGST credit cannot be utilized for payment of SGST or UTGST and vice versa. One may note the fact that IGST credit is available seamlessly, subject to order of utilization as mentioned supra.

5. Sub-Section (6) provides that the balance in the cash or credit ledger after payment of tax, interest, penalty, fee or any other amount may be refunded in accordance with the provisions of section 54 (dealing with refunds).
6. A unique identification number shall be generated at the Common Portal for each debit or credit to the electronic cash or credit ledger, as the case may be. The said UIN must be used to discharge tax liability.

C. ELECTRONIC TAX LIABILITY REGISTER:

1. A **Tax Liability Register** is required to be maintained electronically for all liabilities of a taxable person in **FORM GST PMT-01**.
2. This ledger shall be debited by the following amounts (liability is created by debiting)
 - the amount payable towards tax, interest, late fee or any other amount payable in separate sub-head as per the return furnished by the said taxable person;
 - the amount of tax, interest, penalty or any other amount payable as determined by a proper officer in pursuance of any proceedings under the Act or as ascertained by the said taxable person;
 - the amount of tax and interest payable as a result of mismatch under section 42 or section 43 or section 50; or
 - any amount of interest that may accrue from time to time
 - where Form DRC-03 is being generated for intimation of payment made voluntarily or made against Show Cause Notice, specifying cause of payment
 - o Voluntary
 - o SCN or
 - o Others
 - On generation of Form DRC -03 payment reference number will be generated and found in Part - II of Electronic Liability Register.
3. This ledger shall be credited for the following payments (liability is discharged by crediting)
 - Tax Deducted at Source under section 51
 - Tax Collected at Source under section 52
 - Reverse Charge on supply of goods or services under sub- section 3 of section 9 of CGST /SGST Act, sub-section 3 of section 5 of IGST Act and sub section 3 of

section 7 of UTGST Act

- Tax on supplies from unregistered suppliers under sub section 4 of section 9 of CGST/SGST Act, sub section 4 of section 5 of IGST Act and sub section 4 of section 7 of UTGST Act

The entire procedure cited supra can be pictorially depicted as follows:

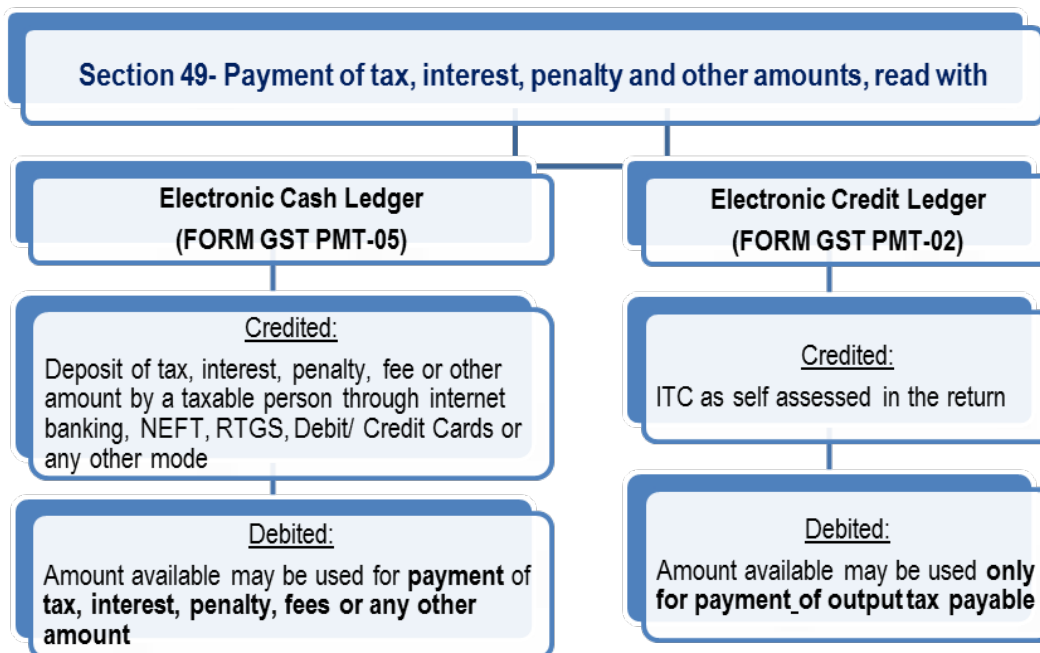

Order of discharge of tax

Sub-Section (8) prescribes the chronological order in which the tax liability of a taxable person can be discharged:

1. Self-assessed tax and other dues arising out of returns for **previous tax periods** must be discharged first.
2. Self-assessed tax and other dues relating to the return of the **current tax period**.
3. Any other amount payable under the Act/Rules (liability arising out of demand notice or adjudicated proceedings etc.).

Presumption that incidence of tax is passed on

Sub-Section (9) of CGST/SGST Act provides that the incidence of tax on goods/services is **deemed** to have been passed on to the recipient of such goods and /or services when the tax is paid unless the contrary is proved.

49.3 Issues and Concerns:

- i. Registered person, while making payment of tax, interest, penalty or any other fee is required to exercise abundant caution, as any incorrect payment made in particular major / minor head cannot be utilised for payment of tax, interest, penalty or any other fee of other major / minor head.
- ii. Recipient of notified services who is liable to reverse charge, is required to ensure that no tax is charged on the Tax invoice issued by the supplier of notified goods or services and all necessary declarations as required under the tax invoice and input tax credit provisions are complied with.
- iii. A Person having multiple registrations is required to ensure that payment of tax is made for the registrations against which the tax liability is due. Any incorrect payment will envisage that the correct payment of taxes under the appropriate registration, while such person needs to seek refund from that particular registration under which the said wrong payment is effected. This will impact working capital and obtaining refunds will envisage time and costs.

49.4 Comparative Review

The Electronic Cash Ledger, Electronic Credit Ledger and Tax Liability Register are unique features of the GST law. This would ensure only eligible credits are availed thereby eliminating the need for Forms such as 'C' or 'F' or 'H' etc. (Ref: Relevant provisions of CST Act 1956).

On the other hand, assessee would be expected to reconcile their financial ledgers with the corresponding Electronic ledgers.

49.5 FAQs

Q1. What are the three types of Ledgers to be maintained by a taxable person under the GST Law?

Ans. The three types of ledgers to be maintained are: Electronic credit ledger, electronic cash ledger and electronic tax liability register.

Q2. What are the deposit amounts that need to be reflected in the Electronic Cash Ledger?

Ans. Electronic Cash Ledger shall contain details of every deposit made towards tax, interest, penalty or any other amount (including the Tax Deducted at Source u/s 51 and Tax Collected at Source u/s 52).

Q3. What is meant by Cross-utilization of credit and how is it done in the Electronic Credit Ledger?

Ans. Cross utilization means utilizing Credit of IGST against liabilities of CGST/ SGST/ UTGST or Credit of CGST / SGST / UTGST against IGST. The amount available in the

Electronic Credit ledger may be used for making payment towards output tax payable under the Act and Rules made thereunder.

Q.4 What are the major and minor heads of Credit in the Electronic Cash Ledger?

Ans

Major heads		Minor Heads
IGST		Tax
CGST		Interest
SGST		Penalty
UTGST		Any other amount
CESS		Fees

Q5. Is cross-utilization permissible among Major heads in the Electronic Cash Ledger?

Ans. No, cross-utilization is not permissible among major heads in the Electronic Cash Ledger. But there is a facility available on Common portal where excess amount paid under major head can be apply for Refund.

Q6. What are the amounts to be reflected in the Electronic Credit Ledger?

Ans. The input tax credit as self-assessed in the details of inward supplies (Form GSTR-2) of a taxable person shall be reflected in the electronic credit ledger.

Q7. Can direct remittances to the treasury be shown in the Electronic Credit Ledger?

Ans. No, direct remittances to the treasury cannot be shown in the electronic credit ledger. But in case of Import of Goods or Payment made under reverse charge has, where credit needs to be first availed, and then it will be reflected in electronic Credit Leader.

Q8. What is the order in which tax liability has to be discharged?

Ans. The order in which the liability of a taxable person must be discharged is as under:

1. Self-assessed tax and other dues arising out of returns for previous tax periods must be discharged first.
2. Self-assessed tax and other dues relating to the return of the current tax period.
3. Any other amount payable under the Act/Rules (liability arising out of demand notice or adjudicated proceedings etc.).

49.6 MCQs

Q1. Deposits towards tax, penalty, interest, fee or any other amount are credited into the ----
----- of a taxable person:

- (a) Electronic Credit Ledger
- (b) Tax Liability Register
- (c) Electronic Cash Ledger
- (d) None of the above

Ans. (c) Electronic Cash Ledger

Q2. The Input Tax Credit as self-assessed by a taxable person is credited into the

- (a) Electronic Credit Ledger
- (b) Tax Liability Register
- (c) Electronic Cash Ledger
- (d) None of the above

Ans. (a) Electronic Credit Ledger

Q3. Cross-Utilization of credit of available IGST after utilization towards payment of IGST is done in the following chronological order:

- (a) CGST then SGST/UTGST
- (b) SGST/UTGST then CGST
- (c) CGST, UTGST and SGST simultaneously
- (d) None of the Above

Ans. (a) CGST then SGST//UTGST

Q4. Which of the following Statements is true?

- (a) ITC of CGST is first utilized for payment of CGST and the balance is utilized for payment of SGST/UTGST
- (b) ITC of SGST is first utilized for payment of SGST and the balance is utilized for payment of CGST
- (c) ITC of CGST is first utilized for payment of CGST and the balance is utilized for payment of IGST
- (d) None of the Above

Ans. (c) ITC of CGST is first utilized for payment of CGST and the balance is utilized for payment of IGST

Statutory provisions**49A. Utilisation of input tax credit subject to certain conditions**

Notwithstanding anything contained in section 49, the input tax credit on account of central tax, State tax or Union territory tax shall be utilised towards payment of integrated tax, central tax, State tax or Union territory tax, as the case may be, only after the input tax credit available on account of integrated tax has first been utilized fully towards such payment.¹

49A.1 Introduction

This section provides for compulsory full utilization of Integrated tax first towards in order of payment i.e IGST, CGST, SGST/UTGST

49A.2 Analysis

The full utilization of IGST credit by taxpayer facilitates the Government the following;

- (a) Reduction of transactions of inter -settlement between the Centre & States
- (b) Self utilization of IGST deposited in Consolidated Fund of India through payment route of taxpayer instead of post return calculation

However, in few situations it leads to situation wherein taxpayer has to pay SGST in cash while his balance in CGST Credit ledger still lying.

Illustration :

Nature of Tax	Tax liability	ITC available
IGST	100(ip)	200 (ic)
CGST	100 (cp)	50 (cc)
SGST	100 (sp)	50 (sc)

	As per Old provision			As per New provisions		
	Tax liability	Paid through ITC	Paid through Cash / Balance Credit	Paid through ITC	Paid through Cash	Balance ITC
IGST	100 (ip)	100 (ic)	Nil	100 (ic)	-	-
CGST	100 (cp)	50 (ic) 50 (cc)	Nil	100 (ic)	-	50 (cc)
SGST	100 (sp)	50 (ic) 50 (sc)	Nil	50 (sc)	50	-

¹ Inserted vide The Central Goods and Services Amendment Act, 2018 w.e.f. 01.02.2019

Statutory provisions**49B. Order of utilisation of input tax credit**

Notwithstanding anything contained in this Chapter and subject to the provisions of clause (e) and clause (f) of sub-section (5) of section 49, the Government may, on the recommendations of the Council, prescribe the order and manner of utilisation of the input tax credit on account of integrated tax, central tax, State tax or Union territory tax, as the case may be, towards payment of any such tax.”

49B.1 Introduction

This provision empowers Government on the recommendation of the Council to prescribe order and manner of utilization of the Input tax credit through rules / notification. It will facilitate changes in the mechanism of payment without amendment of law.

Statutory provisions**50. Interest on delayed payment of tax**

- (1) *Every person who is liable to pay tax in accordance with the provisions of this Act or the rules made thereunder, but fails to pay the tax or any part thereof to the Government within the period prescribed, shall, for the period for which the tax or any part thereof remains unpaid, pay, on his own, interest at such rate, not exceeding eighteen per cent, as may be notified by the Government, on the recommendation of the Council.*
- (2) *The interest under sub-section (1) shall be calculated, in such manner as may be prescribed, from the day succeeding the day on which tax was due to be paid.*
- (3) *A taxable person who makes an undue or excess claim of input tax credit under sub-section (10) of section 42 or undue or excess reduction in output tax liability under sub-section (10) of section 43, shall pay interest on such undue or excess claim or on such undue or excess reduction, as the case may be, at such rate not exceeding twenty four per cent, as may be notified by the Government on the recommendations of the Council.*

Relevant circulars, notifications, clarifications issued by Government:

1. Notification No. 13/2017 – Central Tax dated 28.06.2017 – Prescribing rate of interest payable for delay in payment of tax / issue of refunds.

Related provisions of the Statute

Section or Rule	Description
Section 2(62)	Definition of Input Tax
Section 2(82)	Definition of Output Tax
Section 2(94)	Definition of Registered Person
Section 2(97)	Definition of Return
Section 2(117)	Definition of Valid Return
Section 9	Levy and Collection
Section 16	Eligibility and Conditions for Taking Input Tax Credit
Section 17	Apportionment of Credits and Blocked Credits
Section 39	Furnishing of Returns
Section 42	Matching, reversal and reclaim of input tax credit
Section 43	Matching, reversal and reclaim of reduction in output tax liability
Section 77	Tax Wrongfully Collected and Paid to Central or State Government
Section 19 (IGST)	Tax Wrongfully Collected and Paid to Central or State Government

50.1 Introduction

This section lays down the provisions for payment of interest under the Act for delayed payment of tax.

50.2 Analysis

Section 50 of CGST Act makes it mandatory for a tax payer to pay interest on belated payment of tax i.e. when he fails to pay tax (or any part of tax) to the Government's account within the due date/s.

Interest - When Payable

Interest under section 50 of CGST Act is payable in the following three circumstances

1. Sub-section (1): period for which there is a delay in payment of tax, in full or in part
2. Sub-section (3): Undue or excess claim of input tax credit under section 42 (10) contravening the provisions of section 42(7)
3. Sub-section (3): Undue or excess reduction in output tax liability under section 43 (10) contravening the provisions of section 43(7)

It may be recalled that –

- a) section 42 (10) CGST/SGST Act deals with contravention of provisions for matching of claims for input tax credit by a recipient and
- b) section 43 (10) CGST/SGST Act deals with contravention of provisions for matching of claims for reduction in output tax liability by a supplier

Section 42(7) and 43(7) only deals with discrepancies in matching of credits & reduction in output tax liability against credit notes issued, between a supplier / recipient. All other discrepancies that do not relate to matching would attract interest at the higher rate of 24%. For instance if the supplier discloses output taxes in respect of a particular invoice – say after the 30th of September (which is technically the due date for availment of all credits) then the recipient would not be in a position to avail the entire credit in the first place while the supplier would need to pay the output taxes as well as interest. In this situation what would be the rate of interest – 18% pa or at 24% pa. The readers may debate this issue.

Rate of Interest

The actual rate of interest notified by the Government vide *Notification no. 13/ 2017 Central tax Dated 28 June 2017* are as follows:

S. No.	CGST Act, 2017 Sections	Section description	Rate of interest
1	50(1)	Failure to pay tax or part thereof to the Government within period prescribed	18%
2	50(3)	For undue or excess claim of ITC or reduction of output tax liability	24%
3	54(12)	Interest on withheld refund	6%
4	56	Interest on delayed refunds	6%
5	Proviso to 56	Interest on refund arising from order passed by Adjudicating Authority/ Appellate Authority/ Tribunal/ Court and not refunded within 60 days	9%

Manner of Computation of Interest

1. The manner of computation of period for which interest under sub-section (1) or sub-section (3) is to be paid has not been addressed in the Rules. Generally, the period of interest shall be from the date following the due date of payment to the actual date of payment of tax. Payment of tax as per rule 85(3) be considered only when electronic cash ledger or electronic credit ledger of the registered person is being debited. Mere, credit entry in cash ledger or credit ledger will not tantamount to payment of tax.

It may be noted that Section 39 (7) lays down the last date for remittance, as the last date on which the taxable person is required to furnish such return. Also, Section 2 (117) lays down that a return shall be considered valid, only if the tax payable as per the return is paid in full.

2. Sections 73 (5) & 73 (6) provide that if the tax along with interest has been paid, the adjudicating authority shall not serve any show cause notice.
3. Section 73 (8) provides that where a person has been served with show cause notice but has made the payment of tax and penal interest under Section 50 within thirty days of issue of notice, no penalty is payable and all proceedings in respect of that tax amount are deemed to be concluded. The issue is – whether interest is payable u/s 50(1) or 50(3) ?
4. On a conjoint reading of Sections 50 (1), 73 (5), 73 (6) and 73 (8) of the Act, it is evident that where a person makes a voluntary payment of interest along with belated payment of tax whether admitted on his own or within thirty days from the date of issue of show cause notice, then the proceedings are deemed to be concluded and no penalty is leviable.

Other Important Points to Note

1. The term 'tax' here means the tax payable under the Act or Rules made thereunder.
2. The phrase 'on his own' used in sub-section (1) indicates that such payment of interest should be made voluntarily (i.e.) even without a demand.
3. There are no specific provisions for payment of interest on the interest amount due.
4. The interest payable under this section shall be debited to the Electronic Tax Liability Register as per sub Rule 1 of Rule 85
5. Such liability for interest can be settled by adjustment with balance in Electronic Cash Ledger but not with balance in Electronic Credit Ledger

50.3 Issues and Concerns:

- i. Unlike Central Excise or Service Tax Law, where interest was to be paid only when CENVAT Credit was *availed and utilised* incorrectly. In a GST regime availing of incorrect input tax credit is sufficient cause to attract the provisions of liability to pay interest. However, due to deferment of GSTR 2 and GSTR 3, section 50(3) may not become operational to demand interest on ineligible credit availed but not utilized.
- ii. Further, due to section 50(2) stating that the 'manner of computation is to be prescribed' some experts hold the view that until any method is prescribed, merely prescribing the rate of interest would not suffice to demand interest.
- iii. When there is change in the value of input tax credit (common credit) to be reversed to the extent it relates to exempt turnover on the basis of amounts calculated finally at the

end of the financial year is liable to interest immediately from first day of subsequent financial year, whereas Central Excise Act, 1944, Finance Act 1994 read with CENVAT Credit Rules, 2004 allowed time for reversal without interest upto 30.06 of the subsequent financial year.

- iv. In previous law amount credited to PLA or paid by challan was considered to be a payment of tax and interest is payable till the amount is paid through challan. In GST interest is to be paid till the electronic cash or electronic credit ledgers are not debited.

50.4 Comparative Review

1. This provision is similar to that in service tax and excise laws. In the case of VAT laws, if the payment of tax and interest is after issuance of show cause notice, it is at the discretion of the adjudicating authority to drop the penalty. Some State VAT laws have mandatory penalty provisions.
2. The view laid down by the Hon'ble Supreme Court in [Prathibha Processors v. UOI (1996) 11 SCC 101] that interest is automatic as it is compensatory in nature and not penal in character, holds good even under the subject Act.

50.5 FAQs

Q1. When is a person liable to pay interest?

Ans. When a person who is liable to pay tax under the provisions of the Act or the respective rules made thereunder, fails to pay the whole/ part of the tax due, to the account of the Government, within the prescribed time, he shall be liable to pay interest.

Q2. How is the interest computed?

Ans. Interest is computed for the period for which the tax remains unpaid at the notified rate not exceeding 18%, i.e., from the date following the day on which tax becomes due to be paid, till the date of payment of tax.

Q3. Is penalty still payable if a person pays the tax and interest as per show cause notice?

Ans. Where the person has made payment of tax and interest under Section 50 within thirty days of issue of the show cause notice, no penalty is payable and all proceedings in respect of that tax amount is deemed to be concluded.

Q4. Is interest leviable on excess reduction of reduction of Output tax liability?

Ans. Yes, interest is also leviable where there is undue or excess reduction in output tax liability under section 43 (10) of CGST Act at the rate of 24% per annum.

Q5. Is a show cause notice or demand required to determine the liability to pay interest?

Ans. No, there is no requirement of demand from the department to determine the interest liability. It is the responsibility of the person liable to pay tax to compute and pay the interest 'on his own'.

50.6 MCQs

Q1. Interest is payable on: -

- (a) Belated payment of tax
- (b) Undue/excess claim of Input Tax Credit in case matching
- (c) Undue/Excess reduction of output tax liability
- (d) All of the above

Ans. (d) All of the above

Q2. Interest is calculated: -

- (a) From the date following the day on which tax becomes due to be paid
- (b) Last day such tax was due to be paid
- (c) No periods specified
- (d) None of the above

Ans. (a) from the date following the day on which tax becomes due to be paid

Statutory provisions**51 Tax Deduction at Source**

(1) *Notwithstanding anything to the contrary contained in this Act, the Government may mandate, —*

- (a) *a department or establishment of the Central Government or State Government; or*
- (b) *local authority; or*
- (c) *Governmental agencies; or*
- (d) *such persons or category of persons as may be notified by the Government on the recommendations of the Council,*

(hereafter in this section referred to as “the deductor”), to deduct tax at the rate of one per cent from the payment made or credited to the supplier (hereafter in this section referred to as “the deductee”) of taxable goods or services or both, where the total value of such supply, under a contract, exceeds two lakh and fifty thousand rupees:

Provided that no deduction shall be made if the location of the supplier and the place of supply is in a State or Union territory which is different from the State or as the case may be, Union territory of registration of the recipient.

Explanation.—For the purpose of deduction of tax specified above, the value of supply shall be taken as the amount excluding the central tax, State tax, Union territory tax, integrated tax and cess indicated in the invoice.

- (2) *The amount deducted as tax under this section shall be paid to the Government by the deductor within ten days after the end of the month in which such deduction is made, in such manner as may be prescribed.*
- (3) *The deductor shall furnish to the deductee a certificate mentioning therein the contract value, rate of deduction, amount deducted, amount paid to the Government and such other particulars in such manner as may be prescribed.*
- (4) *If any deductor fails to furnish to the deductee the certificate, after deducting the tax at source, within five days of crediting the amount so deducted to the Government, the deductor shall pay, by way of a late fee, a sum of one hundred rupees per day from the day after the expiry of such five-day period until the failure is rectified, subject to a maximum amount of five thousand rupees.*
- (5) *The deductee shall claim credit, in his electronic cash ledger, of the tax deducted and reflected in the return of the deductor furnished under sub-section (3) of section 39, in such manner as may be prescribed.*
- (6) *If any deductor fails to pay to the Government the amount deducted as tax under sub-section (1), he shall pay interest in accordance with the provisions of sub-section (1) of section 50, in addition to the amount of tax deducted.*
- (7) *The determination of the amount in default under this section shall be made in the manner specified in section 73 or section 74.*
- (8) *The refund to the deductor or the deductee arising on account of excess or erroneous deduction shall be dealt with in accordance with the provisions of section 54:
Provided that no refund to the deductor shall be granted, if the amount deducted has been credited to the electronic cash ledger of the deductee.*

Relevant circulars, notifications, clarifications issued by Government

1. Notification No. 50/2018 – Central Tax dated 13.09.2018 – appoints the 1st day of October, 2018, as the date on which the provisions of section 51 of the said Act shall come into force & specifying persons or category of persons liable to deduct tax under Section 51(1)(b).
2. Notification No.61/2018 Central Tax dated 05.11.2018 retrospectively exempting applicability of TDS provision on supply of goods & service from one PSU to other PSU.

Related provisions of the Statute

Section or Rule	Description
Section 2(43)	Definition of Electronic Cash Ledger
Section 2(53)	Definition of Government

Section 2(82)	Definition of Output Tax
Section 2(94)	Definition of Registered Person
Section 2(97)	Definition of Return
Section 2(117)	Definition of Valid Return
Section 49	Payment of tax
Section 39	Furnishing of Returns

51.1 Introduction

With an objective of ensuring smooth rollout of GST, the provisions of Tax Deduction at Source (Section 51 of the CGST / SGST Act 2017) and Tax Collection at Source (Section 52 of the CGST/SGST Act, 2017) has been postponed. Thereby, Persons who will be liable to deduct or collect tax at source will be required to take registration, but the liability to deduct or collect tax will arise from the date the respective sections are brought in force. It has further been clarified that persons supplying goods or services through electronic commerce operator liable to collect tax at source would not be required to obtain registration immediately, unless they are so liable under Section 22 or any other category specified under Section 24 of the CGST Act, 2017.

The GST Council in the 26th GST council meeting, held on 10.03.2018 decided that the provisions for TDS under section 51 of the CGST Act and TCS under section 52 of the CGST Act shall remain suspended till 30.06.2018.

Notification No. 33/2017 – Central Tax has appointed 18th September 2017 notifies the following persons under Section 51(1)(d) as liable for TDS;

- (a) an authority or a board or any other body, -
 - (i) set up by an Act of Parliament or a State Legislature; or
 - (ii) established by any Government,
 with fifty-one percent or more participation by way of equity or control, to carry out any function;
- (b) society established by the Central Government or the State Government or a Local Authority under the Societies Registration Act, 1860 (21 of 1860);
- (c) public sector undertakings:

The Notification also states that TDS provisions shall come into effect **from a date to be notified** subsequently, on the recommendations of the Council, by the Central Government.

Notification No. 50/2018 Central Tax dated 13.09.2018 seeks to bring section 51 of the CGST Act (provisions related to TDS) into force w.e.f 01.10.2018. Reference may be had to circular 76/50/2018-GST dated 31 December, 2018 which makes it clear that the 51%

condition is applicable to both limbs of 'authority or board' appearing in notification issued under section 51(1)(d) (under para (a) above).

This section provides for deduction of tax at source in certain circumstances. The Section specifically lists out the deductors who are mandated by the Central Government to deduct tax at source, the rate of tax deduction and the procedure for remittance of the tax deducted. The amount of tax deducted is reflected in the Electronic Cash Ledger of the deductee.

51.2 Analysis

CGST Act vide Section 2 (53) defines the term Government to *mean* the Central Government. Section 51 (1), *ibid* refers to TDS related mandating by 'Government' (Central/State Government). Such mandating shall be for the following persons -

Department or Establishment of Central Government or State Government
Local Authority.
Government Agencies.
Persons or category of persons notified by the Central Government on recommendation of the Council. (Notified vide Notification No. 33/2017- Central Tax)

1. The above 'persons' are referred to as deductors.
2. The deductors have to deduct tax at the rate of 1% from the payment made or credited to the supplier of taxable goods and / or services, notified by the Central Government or State Government on the recommendations of the Council. Deduction is required where the total value of supply under 'a contract' exceeds INR 2.5 lakhs. Value of supply shall exclude the tax indicated in the invoice. No deduction shall be made if the location of the supplier and the place of supply is in a State or Union territory which is different from the State or as the case may be, Union territory of registration of the recipient.
3. TDS applies on 'taxable goods or services' supplied and not on 'all taxable supplies'. Please note that 'taxable supplies' is defined in section 2(108) of CGST Act which covers all supplies that are 'leviable' to tax (even if exempt by notification under section 11 of CGST Act). But, 'taxable goods and services' requires to inquire into whether the goods or services are taxable or exempt. If they are exempt, then TDS will not apply.
4. TDS, however, apply even if the supplier is unregistered or composition tax payer. Reference may be had to GSTR 4 (composition) which provides table 9 'TDS Credit'. As regard unregistered supplier, TDS is unrecoverable. Due to repeated extensions, it is not clear if TDS can be deposited 'Without GSTIN' of Deductee.
5. The amount deducted shall be paid to the Central Government within ten days after the end of the month in which such deduction is made.

Sub Rule 9 of rule 87 of the CGST rules provides) that payment shall be made by debiting the electronic cash ledger and crediting the electronic tax liability register.

6. As per Rule 66, the deductor shall furnish a TDS certificate in Form GSTR-7A to the deductee mentioning therein the following:
 - (a) contract value
 - (b) rate of deduction
 - (c) Amount deducted
 - (d) Amount paid to the appropriate Government
 - (e) Any other particulars as may be prescribed

This certificate has to be furnished within five days of remittance as mentioned above.

7. Certificate not furnished by the deductor: - If the deductor does not furnish the certificate of deduction-cum- remittance within five days of the remittance, the deductor has to pay a late fee of INR 100 per day from the 6th day until the day he furnishes the certificate. The maximum late fee is prescribed as INR 5000.
8. Non-remittance by the deductor: If the deductor does not remit the amount deducted as TDS, he is liable to pay penal interest under Section 50 in addition to the amount of tax deducted.
9. The amount of tax deducted reflected in Electronic Cash Ledger of deductee in the return in Form GSTR-7 filed by deductor shall be claimed as credit.

This provision enables the Government to cross-check whether the amount deducted by the deductor is correct and that there is no mis-match between the amount reflected in the Electronic Cash Ledger as reflected in the return filed by deductor. One may draw easy analogy from existing practice in income tax related E-TDS returns filed by deductor and 26AS statement available for viewing the TDS remitted in respect of his transactions by deductee.
10. Refund on excess collection: The deductor or the deductee can claim refund of excess deduction or erroneous deduction. The provisions of section 54 relating to refunds would apply in such cases. However, if the amount deducted has been credited to the Electronic Cash Ledger of the deductee, the deductor cannot claim refund (only deductee can claim).
11. As mentioned above, UTGST Act 2017, subject to its own provisions, adopts the provisions in CGST Act in respect of Tax Deduction at Source *mutatis mutandis* (Ref: Sec 21 of UTGST Act).

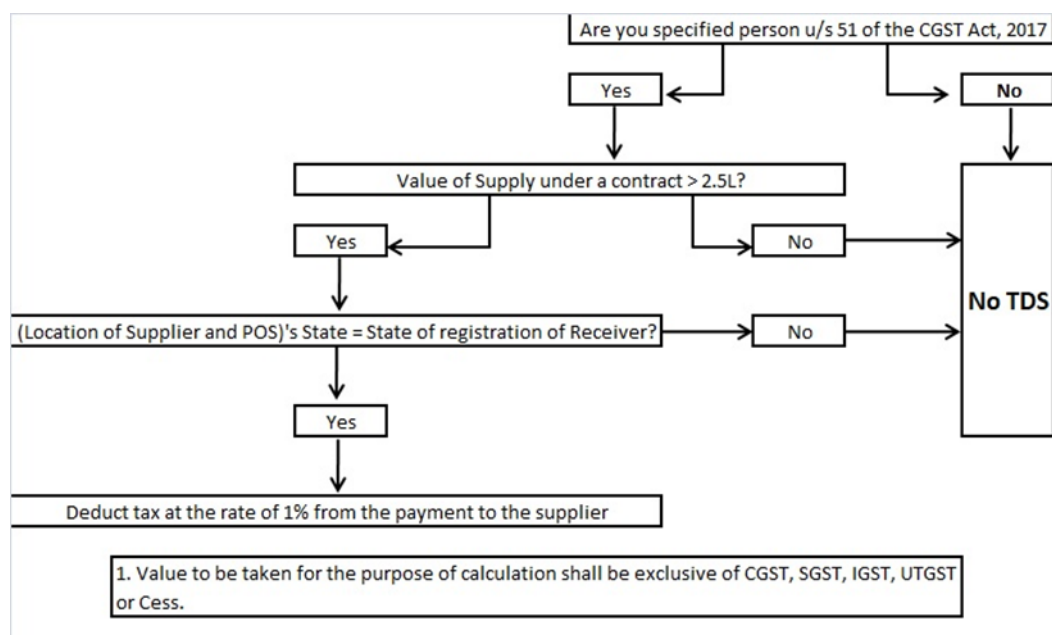

51.3 Comparative review

Provisions for deduction of tax at source exist in the VAT laws. There were no TDS provisions in central excise or service tax laws, though there was a concept of reverse charge. Under most State VAT laws, TDS provisions are applicable on payments made to works contractors. Some States had provisions for TDS on 'transfer of right to use goods'

Comparative table between State VAT Law and CGST Act:

S. No.	State VAT Law	CGST Act
1.	Applicable only to works contractors.	Applicable to recipients notified by the Central Government on recommendations of GST council.
2.	Two different standard rates	One standard rate viz. 1%
3.	Deductor- every works contractee or awarder of contract	(a) A department or establishment of the Central or State Government, or (b) Local authority, or (c) Governmental agencies, or (d) Such persons or category of persons as may be notified, by the Central or a State Government on the recommendations of the Council (Refer Notification 33/2017 – Central Tax and para 51.1)

4.	Two certificates have to be furnished by the Deductor. 1. Certificate of deduction 2. Certificate of remittance.	One single certificate of deduction –cum-remittance to be furnished by the Deductor within five days of remittance.
5.	If certificate of deduction alone is furnished by the Deductor, burden on the works contractor to prove deduction of tax at source.	No such burden cast on the Deductee. More onus is on the Deductor.
6.	Refund provisions and Credit provisions not clear.	Refund provisions clear. Credit can also be claimed from the amount reflected in the Electronic Cash Ledger.
7.	TDS would apply on payments towards transfer of property in goods in the State. Inter-state supplies are generally not subject to TDS.	TDS would apply on the payment made or credited to the supplier. No TDS on interstate supplies.

51.4 FAQs

Q1. Who are the 'persons' who can deduct tax at source under Section 51 of CGST Act?

Ans. The following persons are to deduct tax at source as per the provisions of Section 51 of the CGST Act:

- (a) A department or establishment of the Central or State Government,
- (b) Local authority,
- (c) Governmental agencies,
- (d) Such persons or category of persons as may be notified, by the Central or a State Government on the recommendations of the Council.

Q.2 Under what circumstances can the Deductors mentioned in Section 51 deduct tax at source?

Ans. The Deductors u/s 51 are required to deduct tax from the payment made or credited to the supplier of taxable goods and/ or services, notified by the Central Government on the recommendations of the Council, where the total value of such supply, under a contract, exceeds rupees 2.50 lakh. Also no deduction will be made if the location of supplier and the place of supply is in a state which is different from the state of registration of the recipient.

Q3. What is the rate of tax deduction at source?

- Ans. The prescribed rate of tax to be deducted at source is 1% from the payment made or credited to the supplier of taxable goods and / or services.
- Q4. What is the time limit for remittance of the deducted tax by the deductor into the credit of the Government?
- Ans. The amount deducted shall be paid to the credit of the Government within 10 days from the end of the month in which such deduction is made.
- Q5. What is the nature of certificate to be furnished by the deductor to the deductee and what is the time limit?
- Ans. The Deductor shall furnish a certificate in in Form GSTR-7A mentioning therein the contract value, rate of deduction, amount deducted, amount paid to the appropriate Government and such particulars as may be prescribed in this behalf, to the deductee. This certificate is to be furnished within five days of crediting the amount so deducted to the appropriate Government, failing which, the deductor would be liable to pay late fee being rupees one hundred per day during which the failure continues but subject to Maximum of rupees 5000.
- Q6. Can the deductee claim credit of the remittance of TDS amount by the Deductor?
- Ans. Yes, the deductee can claim credit of the tax deducted, in his electronic cash ledger. This deduction would also be reflected in the return of the deductor filed under sub-section (3) of Section 39, in the manner prescribed.
- Q7. Can tax, once deducted, be claimed as a refund? Who can claim refund?
- Ans. Yes, it is possible to claim refund arising on account of excess or erroneous deduction, and this would be governed by the provisions of Section 54.
- Such refund may be claimed either by the deductor or the deductee, but not both. Further, no refund would be available to the deductor once the amount deducted has been credited to the electronic cash ledger of the deductee.
- Q8. When is the effective date of applicability of TDS provisions?
- Ans. 1st Oct 2018 is the effective date for applicability of TDS provisions.
- Q9. Whether TDS is liable to be deducted on supply of goods & service form one PSU to another PSU?
- Ans. No. TDS is not liable to be deducted by one PSU on another PSU retrospectively 1st Oct 2018 as per the Notification 61/2018 CT dated 05.11.2018.
- Q.10 Whether TDS is liable to be deducted on the rate contract where single supply is below INR 2.5 Lacs but during the year cumulative supplies are more then INR 2.5 Lacs.
- Ans. No. In case of rate contract it is for the applicable rates for different supply and not contract per se. In such cases where single supply is not greater then INR 2.5 Lacs no need to deduct TDS.

51.6 MCQs

Q1. The deduction of tax by the Deductor under Section 51 of CGST Act is at the rate of:

- (a) 2%
- (b) 3%
- (c) 1%
- (d) None of the above.

Ans. (c) 1%

Q2. The amount of tax deducted by the deductor has to be paid to the credit of the appropriate Government within days after the end of the month in which such deduction is made:

- (a) 20 days
- (b) 10 days
- (c) 15 days
- (d) 5 days

Ans. (b) 10 days

Q3. The time limit for furnishing the deduction –cum- remittance certificate by the deductor to the deductee is:

- (a) 10 days
- (b) 20 days
- (c) 5 days
- (d) None of the above.

Ans. (c) 5 days

Q4. The deductee can claim credit of the remittance made by the Deductor in his,

- (a) Electronic Credit Ledger
- (b) Tax liability Ledger
- (c) Electronic Cash Ledger
- (d) None of the above.

Ans. (c) Electronic Cash Ledger

Q5. If excess or erroneous deduction has been made by the Deductor and this amount is credited to Electronic Cash Ledger of the Deductee, refund can be claimed by,

- (a) Deductor
- (b) Deductee

- (c) Both Deductor and Deductee
- (d) None of the above

Ans. (b) Deductee

Q6. Tax deduction shall be made if -

- (a) A contract is for an amount exceeds ₹ 25 lakh
- (b) A supplier supplies goods or services or both exceeding ₹ 2.5 lakh in a year
- (c) A recipient receives goods or services or both exceeding ₹ 2.5 lakh in a year from various contractors
- (d) None of the above

Ans. (b) A supplier supplies goods or services or both exceeding ₹ 2.5 lakh in a year

Statutory provisions

52. Collection of tax at Source

(1) *Notwithstanding anything to the contrary contained in this Act, every electronic commerce operator (hereafter in this section referred to as the “operator”), not being an agent, shall collect an amount calculated at such rate not exceeding one per cent., as may be notified by the Government on the recommendations of the Council, of the net value of taxable supplies made through it by other suppliers where the consideration with respect to such supplies is to be collected by the operator.*

Explanation.—For the purposes of this sub-section, the expression “net value of taxable supplies” shall mean the aggregate value of taxable supplies of goods or services or both, other than services notified under sub-section (5) of section 9, made during any month by all registered persons through the operator reduced by the aggregate value of taxable supplies returned to the suppliers during the said month.

- (2) *The power to collect the amount specified in sub-section (1) shall be without prejudice to any other mode of recovery from the operator.*
- (3) *The amount collected under sub-section (1) shall be paid to the Government by the operator within ten days after the end of the month in which such collection is made, in such manner as may be prescribed.*
- (4) *Every operator who collects the amount specified in sub-section (1) shall furnish a statement, electronically, containing the details of outward supplies of goods or services or both effected through it, including the supplies of goods or services or both returned through it, and the amount collected under sub-section (1) during a month, in such form and manner as may be prescribed, within ten days after the end of such month.*

- (5) *Every operator who collects the amount specified in sub-section (1) shall furnish an annual statement, electronically, containing the details of outward supplies of goods or services or both effected through it, including the supplies of goods or services or both returned through it, and the amount collected under the said sub-section during the financial year, in such form and manner as may be prescribed, before the thirty first day of December following the end of such financial year.*
- (6) *If any operator after furnishing a statement under sub-section (4) discovers any omission or incorrect particulars therein, other than as a result of scrutiny, audit, inspection or enforcement activity by the tax authorities, he shall rectify such omission or incorrect particulars in the statement to be furnished for the month during which such omission or incorrect particulars are noticed, subject to payment of interest, as specified in sub-section (1) of section 50:*
- Provided that no such rectification of any omission or incorrect particulars shall be allowed after the due date for furnishing of statement for the month of September following the end of the financial year or the actual date of furnishing of the relevant annual statement, whichever is earlier.*
- (7) *The supplier who has supplied the goods or services or both through the operator shall claim credit, in his electronic cash ledger, of the amount collected and reflected in the statement of the operator furnished under sub-section (4), in such manner as may be prescribed.*
- (8) *The details of supplies furnished by every operator under sub-section (4) shall be matched with the corresponding details of outward supplies furnished by the concerned supplier registered under this Act in such manner and within such time as may be prescribed.*
- (9) *Where the details of outward supplies furnished by the operator under sub-section (4) do not match with the corresponding details furnished by the supplier under section 37, the discrepancy shall be communicated to both persons in such manner and within such time as may be prescribed.*
- (10) *The amount in respect of which any discrepancy is communicated under sub-section (9) and which is not rectified by the supplier in his valid return or the operator in his statement for the month in which discrepancy is communicated, shall be added to the output tax liability of the said supplier, where the value of outward supplies furnished by the operator is more than the value of outward supplies furnished by the supplier, in his return for the month succeeding the month in which the discrepancy is communicated in such manner as may be prescribed.*
- (11) *The concerned supplier, in whose output tax liability any amount has been added under sub-section (10), shall pay the tax payable in respect of such supply along with interest, at the rate specified under sub-section (1) of section 50 on the amount so added from the date such tax was due till the date of its payment.*

- (12) Any authority not below the rank of Deputy Commissioner may serve a notice, either before or during the course of any proceedings under this Act, requiring the operator to furnish such details relating to—
- (a) supplies of goods or services or both effected through such operator during any period; or
 - (b) stock of goods held by the suppliers making supplies through such operator in the godowns or warehouses, by whatever name called, managed by such operator and declared as additional places of business by such suppliers, as may be specified in the notice.
- (13) Every operator on whom a notice has been served under sub-section (12) shall furnish the required information within fifteen working days of the date of service of such notice.
- (14) Any person who fails to furnish the information required by the notice served under sub-section (12) shall, without prejudice to any action that may be taken under section 122, be liable to a penalty which may extend to twenty-five thousand rupees.
- Explanation.—For the purposes of this section, the expression “concerned supplier” shall mean the supplier of goods or services or both making supplies through the operator.*

Relevant circulars, notifications, clarifications, flyers issued by Government

Notification No51/2018 Central Tax Dated 13.09.2018 to Seeks to bring section 52 of the CGST Act (provisions related to TCS) into force w.e.f 01.10.2018.

Notification No. 52/2018 – Central Tax, dated 20th September, 2018 has notified 0.5% rate for TCS under CGST Act.

Total TCS Rate is 0.5% CGST & 0.5% SGST

Related provisions of the Statute

Section or Rule	Description
Section 2(45)	Definition of Electronic Commerce Operator
Section 2(82)	Definition of Output Tax
Section 2(94)	Definition of Registered Person
Section 24	Compulsory registration in certain cases
Section 49	Payment of tax
Section 50	Interest on delayed payment of tax
Section 122	Penalty for certain offences

52.1 Introduction

This Section provides for collection of tax at source in certain circumstances. The Section specifically lists out the tax collecting persons who are mandated by the Central Government to collect tax at source, the rate of tax collection and the procedure for remittance of the tax collected. The amount of tax collected is reflected in the Electronic Cash Ledger of the person from who tax collected.

Provisions which are common under CGST, UTGST and SGST Act have been analyzed herein.

52.2 Analysis

- (i) Every E-Commerce Operator shall collect TCS at a rate not exceeding 1% on the net value of transaction in which he collects consideration of the supply. Please note that if there is returning of supplies to Suppliers, then the same shall be reduced from the gross value; TCS shall be worked on such net figure only (after such reduction). It is pertinent to note the following definitions here –

Section 2 (44), –

“electronic commerce” means the supply of goods or services or both, including digital products over digital or electronic network;

Section 2 (45), –

“electronic commerce operator” means any person who owns, operates or manages digital or electronic facility or platform for electronic commerce

- (ii) The amount collected so shall be paid to the Central/State Government respectively within ten days after the end of the month in which such collection is made.
- (iii) In case the E-commerce operator fails to collect to tax under sub-section 1 of section 52 or collects an amount which is less than the amount required to be collected under said sub-section or where he fails to pay to the government the amount collected as tax under sub-section 3 of section 52, he shall be liable to penalty under clause (vi) of sub-section 1 of section 122 of the Act which may extend to twenty five thousand along with penalty under of i.e. ₹.10,000 or the amount of TCS involved, whichever is higher.
- (iv) E-Commerce operator shall furnish details of outward supplies of goods or services or both made through it, including the supplies returned through it and the amount collected by it in sub-section 1, in Form GSTR-8 within the 10 days after end of the month in which supplies are made.
- (v) The details of tax collected at source furnished by an E-commerce operator under section 52 in Form GSTR-8 shall be made available to the supplier in Part D of FORM GSTR - 2A electronically through the Common Portal and such taxable person may include the same in FORM GSTR-2.”

- (vi) Section 52 (5) of CGST Act requires filing of Annual Statement by E-Commerce operator on or before 31st December following the year end (31st March of relevant year).
- (vii) The amount of tax collected is reflected in Electronic Cash Ledger of supplier since related monthly return is filed by E-Commerce Operator.
- (viii) Any mismatch between the data submitted by the E-Commerce operator in his monthly returns and that of suppliers making supplies through him shall cause due 'mismatch enquiry' from the proper officer; and either party may rectify the erroneous data. If rectification is not carried out by supplier his offences get confirmed. Short remittance, if any, identified thus will have to be paid by erring supplier (who under reported the turnover) with interest calculated as per Section 50.
- (ix) Any authority, in the rank of Deputy Commissioner or above it can issue a notice – during, or before a proceeding under this Act - to E Commerce Operator seeking information on –
 - (a) supplies of goods or services or both effected through such operator during any period; or
 - (b) stock of goods held by the suppliers making supplies through such operator in the godowns or warehouses, by whatever name called, managed by such operator and declared as additional places of business by such suppliers, as may be specified in the notice.

This shall be a notice which need to be responded within 15 days from the date of receipt by the E Commerce Operator. Failure to submit the required details will cause penalty under Section 52 (14) of the Act which may extend to ₹. 25,000.

- (x) UTGST Act 2017, subject to its own provisions, adopts the provisions in CGST Act in respect of Tax Collection at Source *mutatis mutandis* (Ref: Sec 21 of UTGST Act).

52.3 FAQs

Q1. Who are the 'persons' liable to make collection of tax under Section 52 of CGST Act?

Ans. E Commerce operator (as defined in Section 2 (45)) is the person to collect the tax on net value of taxable Supplies by him/her.

Q2. What is a Net Value of Taxable Supplies for the purpose of TCS u/s 52 of the Act?

Ans. The expression "net value of taxable supplies" shall mean the aggregate value of taxable supplies of goods or services or both, other than services notified under sub-section (5) of section 9, made during any month by all registered persons through the operator reduced by the aggregate value of taxable supplies returned to the supplier during the said month.

Q3. Which format of monthly return has to be filed by E Commerce Operator?

Ans. E Commerce operator shall use form GSTR 8 to make statement of outward supplies made through him in that particular month.

Q4. Whether an E Commerce operator files any annual return? What is the format thereof?

Ans. Section 52 (5) of CGST Act requires filing of Annual return by E Commerce operator on or before 31st December following the year end (31st March of relevant year).

Q5. What is the penalty if an E Commerce operator failed to respond as required in a notice issued by Deputy Commissioner or an officer of higher rank?

Ans. Failure to submit the required details will cause penalty under Section 52 (14) of the Act upto ₹. 25,000. *In addition to this*, penalty under section 122 of the Act 'shall' also be there (₹ 10,000 or the amount of TCS involved, whichever is higher).

52.4 MCQs

Q1. Tax Collection at Source under Section 52 of CGST Law shall be at the rate of:

- (a) 1%
- (b) 2%
- (c) 0.5%
- (d) A percentage not exceeding 1%.

Ans. (d) A percentage not exceeding 1%

Q2. The amount of tax collected by the E Commerce Operator has to be paid to the credit of the appropriate Government within days after the end of the month in which such TCS is made:

- (a) 5 days
- (b) 10 days
- (c) 15 days
- (d) 20 days

Ans. (b) 10 days

Q3. E Commerce operators should file:

- (a) Monthly returns only
- (b) Annual return only
- (c) Quarterly return only
- (d) Monthly Returns as well as Annual Return

Ans. (d) Monthly Returns as well as Annual Return

Q4. A notice to E Commerce operators seeking information can be issued by:

- (a) Superintendent
- (b) Inspector
- (c) Assistant Commissioner
- (d) Deputy Commissioner

Ans. (d) Deputy Commissioner

Q5. E Commerce operator received notice which sought information as per Section 52 of the CGST Act but the failed to duly respond to the same. The penalty -

- (a) Shall not be there
- (b) Penalty u/s 52 shall be there
- (c) Penalty u/s 122 may be there
- (d) Both the penalty u/s 52 as well as 122 shall be there

Ans. (d) Both the penalty u/s 52 as well as 122 shall be there

Statutory provisions

53. Transfer of input tax credit

On utilisation of input tax credit availed under this Act for payment of tax dues under the Integrated Goods and Services Tax Act in accordance with the provisions of sub-section (5) of section 49, as reflected in the valid return furnished under sub-section (1) of section 39, the amount collected as central tax shall stand reduced by an amount equal to such credit so utilised and the Central Government shall transfer an amount equal to the amount so reduced from the central tax account to the integrated tax account in such manner and within such time as may be prescribed.

Related provisions of the Statute

Section or Rule	Description
Section 2(53)	Definition of Government
Section 2(62)	Definition of input tax
Section 2(82)	Definition of output tax
Section 2(94)	Definition of registered person
Section 39	Furnishing of returns

Section 49	Payment of tax
Section 17 (IGST)	Apportionment of tax and settlement of funds

53.1 Introduction

This Section provides simple but important modus operandi in respect of post CGST/SGST/UTGST utilisation towards IGST liability.

53.2 Analysis

U/s 49 (5) (b) (c) and (d) of the Act, SGST / CGST / UTGST credits can be utilised by a tax payer on priority basis to respective SGST / CGST / UTGST dues first. Then, in case of CGST, balance, if any, can be used pay towards IGST. If used so, there shall be reduction in central tax caused by Central Government and equal credit shall be ensured to IGST in the prescribed manner.

Such treatment shall be ensured by the Central Government for UTGST and SGST also in respective cases.

For better clarity, it may please be noted that equivalent provision is there vide Section 18 of Integrated Goods and Services Tax Act 2017.

53.3 Issues and Concerns

None

53.4 FAQs

Q1. If CGST is utilised to pay towards dues of IGST how the Central Government shall ensure due credit to IGST?

Ans. There shall be reduction in CGST on such utilisation; the Central Government shall transfer equivalent amount to the credit of IGST account.

53.5 MCQs

Q1. Section 53 of CGST/SGST Act, 2017 provides for transfer of amount (equivalent to CGST credit utilised) by Central Government to:

- (a) CGST A/c
- (b) SGST A/c
- (c) UTGST A/c
- (d) IGST A/c

Ans. (d) IGST A/c

Chapter 12

Refunds

Sections	Rules
54. Refund of tax	89. Application for refund of tax, interest, penalty, fees or any other amount
55. Refund in certain cases	90. Acknowledgement
56. Interest on delayed refunds	91. Grant of provisional refund
57. Consumer Welfare Fund	92. Order sanctioning refund
58. Utilisation of Fund	93. Credit of the amount of rejected refund claim
	94. Order sanctioning interest on delayed refunds
	95. Refund of tax to certain persons
	96. Refund of integrated tax paid on goods or services exported out of India
	96A. Refund of integrated tax paid on export of goods or services under bond or Letter of Undertaking
	97. Consumer Welfare Fund
	97A. Manual filing and processing

Statutory provisions

54. Refund of tax

(1) *Any person claiming refund of any tax and interest, if any, paid on such tax or any other amount paid by him, may make an application before the expiry of two years from relevant date in such form and manner as may be prescribed:*

Provided that a registered taxable person, claiming refund of any balance in the electronic cash ledger in accordance with the provisions as per sub-section (6) of section 49 may claim such refund in return furnished under section 39 in such manner as may be prescribed.

- (2) *A specialized agency of United Nations Organization or any Multilateral Financial Institution and Organization notified under the United Nations (Privileges and Immunities) Act, 1947, Consulate or Embassy of foreign countries or any other person or class of persons as notified under section 55, entitled to a refund of tax paid by it on inward supplies of goods or services or both, may make an application for such refund, in such form and manner prescribed, before the expiry of six months from the last day of the quarter in which such supply was received*
- (3) *Subject to the provisions of sub-section (10), a registered person may claim refund of any unutilized input tax credit at the end of any tax period:*
- Provided that no refund of unutilized input tax credit shall be allowed in cases other than-*
- (i) *zero rated supplies made without payment of tax*
- (ii) *where the credit has accumulated on account of rate of tax on inputs being higher than the rate of tax on output supplies, other than nil rated or fully exempt supplies, except supplies of goods or services or both as may be notified by the Government on the recommendations of the Council:*
- Provided Further that no refund of unutilized input tax credit shall be allowed in cases where the goods exported out of India are subjected to export duty.*
- Provided also that no refund of input tax credit shall be allowed if the supplier of goods or services or both avails of drawback in respect of central tax or claims refund of the integrated tax paid on such supplies .*
- (4) *The application shall be accompanied by—*
- (a) *such documentary evidence as may be prescribed to establish that a refund is due to the applicant; and*
- (b) *such documentary or other evidence (including the documents referred to in section 33) as the applicant may furnish to establish that the amount of tax and interest, if any, paid on such tax or any other amount paid in relation to which such refund is claimed was collected from, or paid by, him and the incidence of such tax and interest had not been passed on to any other person:*
- Provided that where the amount claimed as refund is less than two lakh rupees, it shall not be necessary for the applicant to furnish any documentary and other evidences but, he may file a declaration, based on the documentary or other evidences available with him, certifying that the incidence of such tax and interest had not been passed on to any other person.*
- (5) *If, on receipt of any such application, the proper officer is satisfied that the whole or part of the amount claimed as refund is refundable, he may make an order accordingly and the amount so determined shall be credited to the Fund referred to in section 57.*

- (6) Notwithstanding anything contained in sub-section (5), the proper officer may, in the case of any claim for refund on account of zero-rated supply of goods or services or both made by registered persons, other than such category of registered persons as may be notified by the Government on the recommendations of the Council, refund on a provisional basis ninety percent of the total amount so claimed, excluding the amount of input tax credit provisionally accepted, in such manner and subject to such conditions, limitations and safeguards as may be prescribed and thereafter make an order under sub-section (5) for final settlement of the refund claim after due verification of documents furnished by the applicant.
- (7) The proper officer shall issue the order under sub-section (5) within sixty days from the date of receipt of application complete in all respects.
- (8) Notwithstanding anything contained in sub-section (5), the refundable amount shall, instead of being credited to the Fund, be paid to the applicant, if such amount is relatable to—
- (a) refund of tax paid on zero rated supplies for **export**¹ of goods or services or both or on inputs or input services used in making such zero rated supplies for **exports**²;
 - (b) refund of unutilized input tax credit under sub-section (3);
 - (c) refund of tax paid on a supply which is not provided, either wholly or partially, and for which invoice has not been issued, or where a refund voucher has been issued;
 - (d) refund of tax in pursuance of section 77;
 - (e) the tax and interest, if any, or any other amount paid by the applicant, if he had not passed on the incidence of such tax and interest to any other person; or
 - (f) the tax or interest borne by such other class of applicants as the Government may, on the recommendation of the Council, by notification, specify.
- (9) Notwithstanding anything to the contrary contained in any judgment, decree, order or direction of the Appellate Tribunal or any Court or in any other provisions of this Act or the rules made thereunder or in any other law for the time being in force, no refund shall be made except in accordance with the provisions of sub-section (8).
- (10) Where any refund is due under the said sub-section(3) to a registered person who has defaulted in furnishing any return or who is required to pay any tax, interest or penalty, which has not been stayed by any Court, Tribunal or Appellate Authority by the specified date, the proper officer may—

¹ Inserted via The Central Goods & Services Tax Amendment Act, 2018 w.e.f 01.02.2019

² Inserted via The Central Goods & Services Tax Amendment Act, 2018 w.e.f 01.02.2019

- (a) withhold payment of refund due until the said person has furnished the return or paid the tax, interest or penalty, as the case may be;
- (b) deduct from the refund due, any tax, interest penalty, fee or any other amount which the taxable person is liable to pay but which remains unpaid under this Act or under the erstwhile law.

Explanation- For the purposes of this sub-section the expression "specified date" shall mean the last date for filing an appeal under this Act.

- (11) Where an order giving rise to a refund is the subject matter of an appeal or further proceedings or where any other proceedings under this Act is pending and the Commissioner is of the opinion that grant of such refund is likely to adversely affect the revenue in the said appeal or other proceeding on account of malfeasance or fraud committed, he may, after giving the taxable person an opportunity of being heard, withhold the refund till such time as he may determine.
- (12) Where a refund is withheld under sub-section (11), the taxable person shall notwithstanding anything contained in section 56, be entitled to interest at such rate not exceeding six per cent, as may be notified on the recommendations of the Council, if as a result of the appeal or further proceedings he becomes entitled to refund.
- (13) Notwithstanding anything to the contrary contained in this section, the amount of advance tax deposited by a casual taxable person or a non-resident taxable person under sub-section (2) of section 27 shall not be refunded unless such person has, in respect of the entire period for which the certificate of registration granted to him had remained in force, furnished all the returns required under section 39.
- (14) Notwithstanding anything contained in this section, no refund under sub-section (5) or sub-section (6) shall be paid to an applicant if the amount is less than one thousand rupees.

Explanation. — For the purposes of this section -

- 1. "refund" includes refund of tax paid on zero-rated supplies of goods or services or both or on inputs or input services used in making such zero-rated supplies, or refund of tax on the supply of goods regarded as deemed exports, or refund of unutilized input tax credit as provided under sub-section (3).
- 2. "relevant date" means –
 - (a) in the case of goods exported out of India where a refund of tax paid is available in respect of the goods themselves or, as the case may be, the inputs or input services used in such goods, -
 - (i) if the goods are exported by sea or air, the date on which the ship or the aircraft in which such goods are loaded, leaves India; or
 - (ii) if the goods are exported by land, the date on which such goods pass the frontier, or

- (iii) *if the goods are exported by post, the date of dispatch of goods by Post Office concerned to a place outside India;*
- (b) *in the case of supply of goods regarded as deemed exports where a refund of tax paid is available in respect of the goods, the date on which the return relating to such deemed exports is furnished;*
- (c) *in the case of services exported out of India where a refund of tax paid is available in respect of services themselves or, as the case may be, the inputs or input services used in such services, the date of -*
- (i) *receipt of payment in convertible foreign exchange **or in Indian rupees where ever permitted by the Reserve Bank of India**³, where the supply of services had been completed prior to the receipt of such payment; or*
- (ii) *issue of invoice, where payment for the service had been received in advance prior to the date of issue of the invoice;*
- (d) *in case where the tax becomes refundable as a consequence of judgment, decree, order or direction of Appellate Authority, Appellate Tribunal or any Court, the date of communication of such judgment, decree, order or direction;*
- (e) ***in the case of refund of unutilised input tax credit under clause (ii) of the first proviso to sub-section (3), the due date for furnishing of return under section 39 for the period in which such claim for refund arises***⁴;
- (f) *in the case where tax is paid provisionally under this Act or the rules made thereunder, the date of adjustment of tax after the final assessment thereof.*
- (g) *in the case of a person, other than the supplier, the date of receipt of goods or services or both by such person; and*
- (h) *in any other case, the date of payment of tax.*

Extract of the CGST Rules, 2017

89. Application for refund of tax, interest, penalty, fees or any other amount.

- 1) *Any person, except the persons covered under notification issued under section 55, claiming refund of any tax, interest, penalty, fees or any other amount paid by him,*

³ Inserted vide The Central Goods & Services Act Amendment Act, 2018 w.e.f. 01.02.2019

⁴ Inserted via The Central Goods & Services tax Amendment Act, 2018 w.e.f 01.02.2019

other than refund of integrated tax paid on goods exported out of India, may file an application electronically in FORM GST RFD-01 through the common portal, either directly or through a Facilitation Centre notified by the Commissioner:

Provided that any claim for refund relating to balance in the electronic cash ledger in accordance with the provisions of sub-section (6) of section 49 may be made through the return furnished for the relevant tax period in FORM GSTR-3 or FORM GSTR-4 or FORM GSTR-7, as the case may be:

Provided further that in respect of supplies to a Special Economic Zone unit or a Special

Economic Zone developer, the application for refund shall be filed by the –

- a) supplier of goods after such goods have been admitted in full in the Special Economic Zone for authorised operations, as endorsed by the specified officer of the Zone;*
- b) supplier of services along with such evidence regarding receipt of services for authorised operations as endorsed by the specified officer of the Zone:*

Provided also that in respect of supplies regarded as deemed exports, the application may be filed by, -

- a) the recipient of deemed export supplies; or***
- b) the supplier of deemed export supplies in cases where the recipient does not avail of input tax credit on such supplies and furnishes an undertaking to the effect that the supplier may claim the refund⁵***

Provided also that refund of any amount, after adjusting the tax payable by the applicant out of the advance tax deposited by him under section 27 at the time of registration, shall be claimed in the last return required to be furnished by him.

- 2) *The application under sub-rule (1) shall be accompanied by any of the following documentary evidences in Annexure 1 in Form GST RFD-01, as applicable, to establish that a refund is due to the applicant, namely:-*
 - a) the reference number of the order and a copy of the order passed by the proper officer or an appellate authority or Appellate Tribunal or court resulting in such refund or reference number of the payment of the amount specified in subsection (6) of section 107 and sub-section (8) of section 112 claimed as refund;*
 - b) a statement containing the number and date of shipping bills or bills of export and the number and the date of the relevant export invoices, in a case where the refund is on account of export of goods;*

⁵ Substituted vide Notf no. 47/2017-CT dt. 18.10.2017

- c) a statement containing the number and date of invoices and the relevant Bank Realisation Certificates or Foreign Inward Remittance Certificates, as the case may be, in a case where the refund is on account of the export of services;
- d) a statement containing the number and date of invoices as provided in rule 46 along with the evidence regarding the endorsement specified in the second proviso to sub-rule (1) in the case of the supply of goods made to a Special Economic Zone unit or a Special Economic Zone developer;
- e) a statement containing the number and date of invoices, the evidence regarding the endorsement specified in the second proviso to sub-rule (1) and the details of payment, along with the proof thereof, made by the recipient to the supplier for authorised operations as defined under the Special Economic Zone Act, 2005, in a case where the refund is on account of supply of services made to a Special Economic Zone unit or a Special Economic Zone developer;
- f) **a declaration to the effect that tax has not been collected from the Special Economic Zone unit or the Special Economic Zone developer, in a case where the refund is on account of supply of goods or services or both made to a Special Economic Zone unit or a Special Economic Zone developer⁶**
- g) a statement containing the number and date of invoices along with such other evidence as may be notified in this behalf, in a case where the refund is on account of deemed exports;
- h) a statement containing the number and the date of the invoices received and issued during a tax period in a case where the claim pertains to refund of any unutilised input tax credit under sub-section (3) of section 54 where the credit has accumulated on account of the rate of tax on the inputs being higher than the rate of tax on output supplies, other than nil-rated or fully exempt supplies;
- i) the reference number of the final assessment order and a copy of the said order in a case where the refund arises on account of the finalisation of provisional assessment;
- j) a statement showing the details of transactions considered as intra-State supply but which is subsequently held to be inter-State supply;
- k) a statement showing the details of the amount of claim on account of excess payment of tax;
- l) a declaration to the effect that the incidence of tax, interest or any other amount claimed as refund has not been passed on to any other person, in a case where the amount of refund claimed does not exceed two lakh rupees:

⁶ Substituted vide Notf no. 03/2019-CT dt. 29.01.2019 wef 01.02.2019 w.e.f 01.02.2019

Provided that a declaration is not required to be furnished in respect of the cases covered under clause (a) or clause (b) or clause (c) or clause (d) or clause (f) of sub-section (8) of section 54;

- m) *a Certificate in Annexure 2 of FORM GST RFD-01 issued by a chartered accountant or a cost accountant to the effect that the incidence of tax, interest or any other amount claimed as refund has not been passed on to any other person, in a case where the amount of refund claimed exceeds two lakh rupees:*

Provided that a certificate is not required to be furnished in respect of cases covered under clause (a) or clause (b) or clause (c) or clause (d) or clause (f) of subsection (8) of section 54;

Explanation.– For the purposes of this rule-

- (i) *in case of refunds referred to in clause (c) of sub-section (8) of section 54, the expression –invoice // means invoice conforming to the provisions contained in section 31;*
- (ii) *where the amount of tax has been recovered from the recipient, it shall be deemed that the incidence of tax has been passed on to the ultimate consumer.*
- 3) *Where the application relates to refund of input tax credit, the electronic credit ledger shall be debited by the applicant by an amount equal to the refund so claimed.*
- 4) *In the case of zero-rated supply of goods or services or both without payment of tax under bond or letter of undertaking in accordance with the provisions of sub-section (3) of section 16 of the Integrated Goods and Services Tax Act, 2017 (13 of 2017), refund of input tax credit shall be granted as per the following formula –*

Refund Amount = (Turnover of zero-rated supply of goods + Turnover of zero-rated supply of services) x Net ITC ÷ Adjusted Total Turnover

Where, -

- (A) *"Refund amount" means the maximum refund that is admissible;*
- (B) *"Net ITC" means input tax credit availed on inputs and input services during the relevant period other than the input tax credit availed for which refund is claimed under sub-rules (4A) or (4B) or both;*
- (C) *"Turnover of zero-rated supply of goods" means the value of zero-rated supply of goods made during the relevant period without payment of tax under bond or letter of undertaking, other than the turnover of supplies in respect of which refund is claimed under sub-rules (4A) or (4B) or both;*
- (D) *"Turnover of zero-rated supply of services" means the value of zero-rated supply of services made without payment of tax under bond or letter of undertaking, calculated in the following manner, namely:-*

Zero-rated supply of services is the aggregate of the payments received during the relevant period for zero-rated supply of services and zero-rated supply of services where supply has been completed for which payment had been received in advance in any period prior to the relevant period reduced by advances received for zero-rated supply of services for which the supply of services has not been completed during the relevant period;

- (E) "Adjusted Total Turnover||" means the sum total of the value of-
- (a) the turnover in a State or a Union territory, as defined under clause (112) of section 2, excluding the turnover of services; and
 - (b) the turnover of zero-rated supply of services determined in terms of clause (D) above and non-zero-rated supply of services, excluding-
 - (i) the value of exempt supplies other than zero-rated supplies; and
 - (ii) the turnover of supplies in respect of which refund is claimed under sub-rule (4A) or sub-rule (4B) or both, if any, during the relevant period⁷;
- (F) – "Relevant period" means the period for which the claim has been filed.

4A) *In the case of supplies received on which the supplier has availed the benefit of the Government of India, Ministry of Finance, notification No. 48/2017-Central Tax dated the 18th October, 2017 published in the Gazette of India, Extraordinary, Part II, Section 3, Subsection (i), vide number G.S.R 1305 (E) dated the 18th October, 2017, refund of input tax credit, availed in respect of other inputs or input services used in making zero-rated supply of goods or services or both, shall be granted.*

- 4B) Where the person claiming refund of unutilised input tax credit on account of zero rated supplies without payment of tax has –
- (a) received supplies on which the supplier has availed the benefit of the Government of India, Ministry of Finance, notification No. 40/2017-Central Tax (Rate), dated the 23rd October, 2017, published in the Gazette of India, Extraordinary, Part II, Section 3, Sub-section (i), vide number G.S.R 1320 (E), dated the 23rd October, 2017 or notification No. 41/2017-Integrated Tax (Rate), dated the 23rd October, 2017, published in the Gazette of India, Extraordinary, Part II, Section 3, Sub-section (i), vide number G.S.R 1321(E), dated the 23rd October, 2017; or
 - (b) availed the benefit of notification No. 78/2017-Customs, dated the 13th October, 2017, published in the Gazette of India, Extraordinary, Part II, Section 3, Subsection (i), vide number G.S.R 1272(E), dated the 13th October, 2017 or

⁷ Substituted vide Notf no. 39/2018-CT dt. 04.09.2018

notification No. 79/2017-Customs, dated the 13th October, 2017, published in the Gazette of India, Extraordinary, Part II, Section 3, Sub-section (i), vide number G.S.R 1299(E), dated the 13th October, 2017,

the refund of input tax credit, availed in respect of inputs received under the said notifications for export of goods and the input tax credit availed in respect of other inputs or input services to the extent used in making such export of goods, shall be granted⁸

- 5) *In the case of refund on account of inverted duty structure, refund of input tax credit shall be granted as per the following formula:-*

Maximum Refund Amount = {(Turnover of inverted rated supply of goods and services) x Net ITC ÷ Adjusted Total Turnover} - tax payable on such inverted rated supply of goods and services.

Explanation:- For the purposes of this sub-rule, the expressions –

- a) *“Net ITC” shall mean input tax credit availed on inputs during the relevant period other than the input tax credit availed for which refund is claimed under sub-rules (4A) or (4B) or both; and*
- b) *Adjusted Total turnover shall have the same meaning as assigned to it in sub-rule (4)⁹*

90. Acknowledgement

- 1) *Where the application relates to a claim for refund from the electronic cash ledger, an acknowledgement in FORM GST RFD-02 shall be made available to the applicant through the common portal electronically, clearly indicating the date of filing of the claim for refund and the time period specified in sub-section (7) of section 54 shall be counted from such date of filing.*
- 2) *The application for refund, other than claim for refund from electronic cash ledger, shall be forwarded to the proper officer who shall, within a period of fifteen days of filing of the said application, scrutinize the application for its completeness and where the application is found to be complete in terms of sub-rule (2), (3) and (4) of rule 89, an acknowledgement in FORM GST RFD-02 shall be made available to the applicant through the common portal electronically, clearly indicating the date of filing of the claim for refund and the time period specified in sub-section (7) of section 54 shall be counted from such date of filing.*

⁸ Substituted vide Notf no. 54/2018-CT dt. 09.10.2018

⁹ Substituted vide Notf no. 74/2018-CT dt.31.12.2018

- 3) *Where any deficiencies are noticed, the proper officer shall communicate the deficiencies to the applicant in FORM GST RFD-03 through the common portal electronically, requiring him to file a fresh refund application after rectification of such deficiencies.*
- 4) *Where deficiencies have been communicated in FORM GST RFD-03 under the State Goods and Service Tax Rules, 2017, the same shall also deemed to have been communicated under this rule along with the deficiencies communicated under sub-rule (3).*

91. Grant of provisional refund

- 1) *The provisional refund in accordance with the provisions of sub-section (6) of section 54 shall be granted subject to the condition that the person claiming refund has, during any period of five years immediately preceding the tax period to which the claim for refund relates, not been prosecuted for any offence under the Act or under an existing law where the amount of tax evaded exceeds two hundred and fifty lakh rupees.*
- 2) *The proper officer, after scrutiny of the claim and the evidence submitted in support thereof and on being prima facie satisfied that the amount claimed as refund under sub-rule (1) is due to the applicant in accordance with the provisions of sub-section (6) of section 54, shall make an order in FORM GST RFD-04, sanctioning the amount of refund due to the said applicant on a provisional basis within a period not exceeding seven days from the date of the acknowledgement under sub-rule (1) or sub-rule (2) of rule 90.*

Provided that the order issued in FORM GST RFD-04 shall not be required to be revalidated by the proper officer¹⁰

- 3) *The proper officer shall issue a payment advice in FORM GST RFD-05 for the amount sanctioned under sub-rule (2) and the same shall be electronically credited to any of the bank accounts of the applicant mentioned in his registration particulars and as specified in the application for refund.*

[Provided that the payment advice in FORM GST RFD-05 shall be required to be revalidated where the refund has not been disbursed within the same financial year in which the said payment advice was issued¹¹.

92. Order sanctioning refund

- 1) *Where, upon examination of the application, the proper officer is satisfied that a refund under sub-section (5) of section 54 is due and payable to the applicant, he*

¹⁰ 1 Inserted vide Notf no. 03/2019-CT dt. 29.01.2019 wef 01.02.2019

¹¹ Inserted vide Notf no. 03/2019-CT dt. 29.01.2019 wef 01.02.2019

shall make an order in FORM GST RFD-06 sanctioning the amount of refund to which the applicant is entitled, mentioning therein the amount, if any, refunded to him on a provisional basis under sub-section (6) of section 54, amount adjusted against any outstanding demand under the Act or under any existing law and the balance amount refundable:

Provided that in cases where the amount of refund is completely adjusted against any outstanding demand under the Act or under any existing law, an order giving details of the adjustment shall be issued in Part A of FORM GST RFD-07.

- 2) *Where the proper officer or the Commissioner is of the opinion that the amount of refund is liable to be withheld under the provisions of sub-section (10) or, as the case may be, sub-section (11) of section 54, he shall pass an order in Part B of FORM GST RFD-07 informing him the reasons for withholding of such refund.*
- 3) *Where the proper officer is satisfied, for reasons to be recorded in writing, that the whole or any part of the amount claimed as refund is not admissible or is not payable to the applicant, he shall issue a notice in FORM GST RFD-08 to the applicant, requiring him to furnish a reply in FORM GST RFD-09 within a period of fifteen days of the receipt of such notice and after considering the reply, make an order in FORM GST RFD-06 sanctioning the amount of refund in whole or part, or rejecting the said refund claim and the said order shall be made available to the applicant electronically and the provisions of sub-rule (1) shall, mutatis mutandis, apply to the extent refund is allowed:*

Provided that no application for refund shall be rejected without giving the applicant an opportunity of being heard.

- 4) *Where the proper officer is satisfied that the amount refundable under sub-rule (1) or sub-rule (2) is payable to the applicant under sub-section (8) of section 54, he shall make an order in FORM GST RFD-06 and issue a payment advice in FORM GST RFD-05 for the amount of refund and the same shall be electronically credited to any of the bank accounts of the applicant mentioned in his registration particulars and as specified in the application for refund.*

Provided that the order issued in FORM GST RFD-06 shall not be required to be revalidated by the proper officer:

Provided further that the payment advice in FORM GST RFD-05 shall be required to be revalidated where the refund has not been disbursed within the same financial year in which the said payment advice was issued.¹²

- 5) *Where the proper officer is satisfied that the amount refundable under sub-rule (1) or*

¹² Inserted vide Notf no. 03/2019-CT dt. 29.01.2019 wef 01.02.2019

sub-rule (2) is not payable to the applicant under sub-section (8) of section 54, he shall make an order in FORM GST RFD-06 and issue an advice in FORM GST RFD-05, for the amount of refund to be credited to the Consumer Welfare Fund.

93. Credit of the amount of rejected refund claim

- 1) *Where any deficiencies have been communicated under sub-rule (3) of rule 90, the amount debited under sub-rule (3) of rule 89 shall be re-credited to the electronic credit ledger.*
- 2) *Where any amount claimed as refund is rejected under rule 92, either fully or partly, the amount debited, to the extent of rejection, shall be re-credited to the electronic credit ledger by an order made in FORM GST PMT-03.*

Explanation.— For the purposes of this rule, a refund shall be deemed to be rejected, if the appeal is finally rejected or if the claimant gives an undertaking in writing to the proper officer that he shall not file an appeal.

95. Refund of tax to certain persons

- 1) *Any person eligible to claim refund of tax paid by him on his inward supplies as per notification issued section 55 shall apply for refund in FORM GST RFD-10 once in every quarter, electronically on the common portal or otherwise, either directly or through a Facilitation Centre notified by the Commissioner, along with a statement of the inward supplies of goods or services or both in FORM GSTR-11.*
- 2) *An acknowledgement for the receipt of the application for refund shall be issued in FORM GST RFD-02.*
- 3) *The refund of tax paid by the applicant shall be available if-*
 - a) *the inward supplies of goods or services or both were received from a registered person against a tax invoice*
 - b) *name and Goods and Services Tax Identification Number or Unique Identity Number of the applicant is mentioned in the tax invoice; and*
 - c) *such other restrictions or conditions as may be specified in the notification are satisfied.*
- 4) *The provisions of rule 92 shall, mutatis mutandis, apply for the sanction and payment of refund under this rule.*
- 5) *Where an express provision in a treaty or other international agreement, to which the President or the Government of India is a party, is inconsistent with the provisions of this Chapter, such treaty or international agreement shall prevail.*

96. Refund of integrated tax paid on goods or services exported out of India

- 1) *The shipping bill filed by [an exporter of goods] shall be deemed to be an application for refund of integrated tax paid on the goods exported out of India and such*

application shall be deemed to have been filed only when:-

- a) the person in charge of the conveyance carrying the export goods duly files an a **departure manifest or** ¹³export manifest or an export report covering the number and the date of shipping bills or bills of export; and
 - b) the applicant has furnished a valid return in FORM GSTR-3or FORM GSTR3B, as the case may be;
- 2) The details of the relevant export invoices in respect of export of goods contained in FORM GSTR-1 shall be transmitted electronically by the common portal to the system designated by the Customs and the said system shall electronically transmit to the common portal, a confirmation that the goods covered by the said invoices have been exported out of India.
- Provided that where the date for furnishing the details of outward supplies in FORM GSTR-1 for a tax period has been extended in exercise of the powers conferred under section 37 of the Act, the supplier shall furnish the information relating to exports as specified in Table 6A of FORM GSTR-1 after the return in FORM GSTR-3B has been furnished and the same shall be transmitted electronically by the common portal to the system designated by the Customs:*
- Provided further that the information in Table 6A furnished under the first proviso shall be auto-drafted in FORM GSTR-1 for the said tax period.*
- 3) Upon the receipt of the information regarding the furnishing of a valid return in FORM GSTR-3or FORM GSTR-3B, as the case may be from the common portal, the system designated by the Customs or the proper officer of Customs, as the case may be, shall process the claim of refund in respect of export of goods and an amount equal to the integrated tax paid in respect of each shipping bill or bill of export shall be electronically credited to the bank account of the applicant mentioned in his registration particulars and as intimated to the Customs authorities.
 - 4) The claim for refund shall be withheld where,-
 - a) a request has been received from the jurisdictional Commissioner of central tax, State tax or Union territory tax to withhold the payment of refund due to the person claiming refund in accordance with the provisions of sub-section (10) or sub-section (11) of section 54; or
 - b) the proper officer of Customs determines that the goods were exported in violation of the provisions of the Customs Act, 1962.
 - 5) Where refund is withheld in accordance with the provisions of clause (a) of sub-rule (4), the proper officer of integrated tax at the Customs station shall intimate the

¹³ Inserted vide Notf no. 74/2018-CT dt. 31.12.2018

applicant and the jurisdictional Commissioner of central tax, State tax or Union territory tax, as the case may be, and a copy of such intimation shall be transmitted to the common portal.

- 6) *Upon transmission of the intimation under sub-rule (5), the proper officer of central tax or State tax or Union territory tax, as the case may be, shall pass an order in Part B of FORM GST RFD-07.*
- 7) *Where the applicant becomes entitled to refund of the amount withheld under clause (a) of sub-rule (4), the concerned jurisdictional officer of central tax, State tax or Union territory tax, as the case may be, shall proceed to refund the amount after passing an order in FORM GST RFD-06.*
- 8) *The Central Government may pay refund of the integrated tax to the Government of Bhutan on the exports to Bhutan for such class of goods as may be notified in this behalf and where such refund is paid to the Government of Bhutan, the exporter shall not be paid any refund of the integrated tax.*
- 9) *The application for refund of integrated tax paid on the services exported out of India shall be filed in FORM GST RFD-01 and shall be dealt with in accordance with the provisions of rule 89*
- 10) The persons claiming refund of integrated tax paid on exports of goods or services should not have –
 - (a) received supplies on which the benefit of the Government of India, Ministry of Finance notification No. 48/2017-Central Tax, dated the 18th October, 2017 published in the Gazette of India, Extraordinary, Part II, Section 3, Sub-section (i), vide number G.S.R 1305 (E), dated the 18th October, 2017 or notification No. 40/2017-Central Tax (Rate), dated the 23rd October, 2017 published in the Gazette of India, Extraordinary, Part II, Section 3, Sub-section (i), vide number G.S.R 1320 (E), dated the 23rd October, 2017 or notification No. 41/2017-Integrated Tax (Rate), dated the 23rd October, 2017 published in the Gazette of India, Extraordinary, Part II, Section 3, Sub-section (i), vide number G.S.R 1321 (E), dated the 23rd October, 2017 has been availed; or
 - (b) availed the benefit under notification No. 78/2017-Customs, dated the 13th October, 2017 published in the Gazette of India, Extraordinary, Part II, Section 3, Sub-section (i), vide number G.S.R 1272(E), dated the 13th October, 2017 or notification No. 79/2017-Customs, dated the 13th October, 2017 published in the Gazette of India, Extraordinary, Part II, Section 3, Sub-section (i), vide number G.S.R 1299 (E), dated the 13th October, 2017 except so far it relates to receipt of capital goods by such person against Export Promotion Capital Goods Scheme.

96A. Refund of integrated tax paid on export of goods or services under bond or Letter of Undertaking

- 1) *Any registered person availing the option to supply goods or services for export*

without payment of integrated tax shall furnish, prior to export, a bond or a Letter of Undertaking in FORM GST RFD-11 to the jurisdictional Commissioner, binding himself to pay the tax due along with the interest specified under sub-section (1) of section 50 within a period of—

- a) *fifteen days after the expiry of three months, or such further period as may be allowed by the Commissioner,] from the date of issue of the invoice for export, if the goods are not exported out of India; or*
 - b) *fifteen days after the expiry of one year, or such further period as may be allowed by the Commissioner, from the date of issue of the invoice for export, if the payment of such services is not received by the exporter in convertible foreign exchange.*
- 2) *The details of the export invoices contained in FORM GSTR-1 furnished on the common portal shall be electronically transmitted to the system designated by Customs and a confirmation that the goods covered by the said invoices have been exported out of India shall be electronically transmitted to the common portal from the said system.*

Provided that where the date for furnishing the details of outward supplies in FORM GSTR-1 for a tax period has been extended in exercise of the powers conferred under section 37 of the Act, the supplier shall furnish the information relating to exports as specified in Table 6A of FORM GSTR-1 after the return in FORM GSTR-3B has been furnished and the same shall be transmitted electronically by the common portal to the system designated by the Customs:

Provided further that the information in Table 6A furnished under the first proviso shall be auto-drafted in FORM GSTR-1 for the said tax period.

- 3) *Where the goods are not exported within the time specified in sub-rule (1) and the registered person fails to pay the amount mentioned in the said sub-rule, the export as allowed under bond or Letter of Undertaking shall be withdrawn forthwith and the said amount shall be recovered from the registered person in accordance with the provisions of section 79.*
- 4) *The export as allowed under bond or Letter of Undertaking withdrawn in terms of sub-rule (3) shall be restored immediately when the registered person pays the amount due.*
- 5) *The Board, by way of notification, may specify the conditions and safeguards under which a Letter of Undertaking may be furnished in place of a bond.*
- 6) *The provisions of sub rule (1) shall apply, mutatis mutandis, in respect of zero-rated supply of goods or services or both to a Special Economic Zone developer or a Special Economic Zone unit without payment of integrated tax.;*

97A. Manual filing and processing

Notwithstanding anything contained in this Chapter, in respect of any process or procedure prescribed herein, any reference to electronic filing of an application, intimation, reply, declaration, statement or electronic issuance of a notice, order or certificate on the common portal shall, in respect of that process or procedure, include manual filing of the said application, intimation, reply, declaration, statement or issuance of the said notice, order or certificate in such Forms as appended to these rules.

Relevant circulars, notifications, clarifications issued by Government

- 1) Notification No.37/2017-Central Tax dated 04.10.2017 issued by CBIC extending facility of LUT to all exporters
- 2) Notification No.39/2017-Central Tax dated 04.10.2017 issued by CBIC empowering State Tax officers for processing and granting of refund
- 3) Notification No. 48/2017-Central Tax dated 18-10-2017 issued by CBIC notifying deemed exports in exercise of powers conferred u/s 147
- 4) Notification 49/2017-Central Tax dated 18.10.2017 issued by CBIC detailing evidences to be produced by the supplier of deemed exports to claim refund
- 5) Notification 20/2018-Central Tax dated 28.03.2018 issued by CBIC extending the due date for filing an application for refund under section 55
- 6) Notification 2154/2018-Central Tax dated 18.04.2018/09.10.2017 issued by CBIC extending the to allow IGST refund claim of credit under Rule 89(5) to input services.
- 7) Notification 26/2018-Central Tax dated 13.06.2018 issued by CBIC substituting clause (a) in sub rule (3) in Rule 95.
- 8) Notification 26/2018-Central Tax dated 13.06.2018 issued by CBIC amending Form GST RFD -01 & GST RFS – 01A to make it in line with the changes made in the formula for calculating Refund under Inverted Duty Structure.
- 9) Notification 39/2018-Central Tax dated 04-09-2018 issued by CBIC making changes in definition of adjusted turnover for the calculation of refund and substituting Rule 96(10) imposing restrictions on refund of IGST paid on exports in certain cases.
- 10) Notification No. 5/2017-Central Tax (Rate) dated 28-06-2017 issued by CBIC notifying supplies of exporters who have received Capital goods in respect of which no refund of unutilized input tax credit shall be allowed under inverted duty rate structure under EPCG scheme.
- 11) Notification No. 15/2017-Central Tax (Rate) dated 28-06-2017 issued by CBIC notifying supplies of services on which no refund of unutilized input tax credit shall be allowed under inverted duty rate structure.

- 12) Notification No. 29/2017-Central Tax (Rate) dated 22-09-2017 issued by CBIC notifying supplies of goods in respect of which no refund of unutilized input tax credit shall be allowed under inverted duty rate structure (Modifying 5/2017- Central Tax (Rate) dated 28-06-2017)
- 13) Notification No. 40/2017-Central Tax (Rate) dated 23-10-2017 issued by CBIC granting exemption for intra state supply of goods or services for export in excess of 0.05%
- 14) Notification no. 44/2017- Central Tax (Rate) dated 14-11-2017 issued by CBIC notifying supplies of goods in respect of which no refund of unutilized input tax credit shall be allowed under inverted duty rate structure (Modifying 5/2017- Central Tax (Rate) dated 28-06-2017)
- 15) Circular No. 8/2017 dated 04.10.2017 issued by CBIC being clarifications on issues related to furnishing of Bond/LUT for exports
- 16) Circular No. 14/14/2017-GST dated 6-11-2017, issued by CBIC regarding procedure on procurement of supplies of goods from DTA by EOU/EHTP/STP/BTP
- 17) Circular No. 17/2017 dated 15.11.2017 issued by CBIC being clarifications on Manual filing and processing of refund claims in respect of zero-rated supplies
- 18) Circular No. 18/18/2017 dated 16-11-2017 issued by CBIC regarding refund of unutilized ITC of gst paid on inputs in respect of exporters of fabrics
- 19) ular No. 24/2017 dated 21.12.2017 issued by CBIC regarding manual filing and processing of refund claims on account of inverted duty structure, deemed exports and excess balance in electronic cash ledger
- 20) Circular No. 30/436/2018 dated 25-01-13.03.2018 issued by CBIC providing clarification on regarding Processing of refund of unutilized ITC on supplies made to Indian Railways applications for UIN entities
- 21) Circular No. 37/2018 dated 15.03.2018 issued by CBIC clarifying export related refund issues.
- 22) Circular No. 40/1443/2018 dated 06-04-2018 issued by CBIC providing clarification on issues relating to furnishing of Bond/LUT
- 23) Circular No. 45/19/2018-GST dated 30.05.2018 issued by CBIC addressing queries relating various issues relating to refund.
- 24) Circular No. 48/2018 –GST dated 14-06-2018 issued by CBIC clarifying issues related to SEZ and refund of unutilized ITC for Job Workers for ISD/Composition dealer and non-resident.
- 25) Circular No. 56/2018-GST dated 24-08-2018 issued by CBIC providing clarifications on removal of restriction on refund of unutilized accumulated ITC on fabrics

- 26) Circular No. 59/33/218-GST dated 04-09-2018 issued by CBIC providing clarification on refund related issues.
- 27) Circular No. 70/2018 dated 26-10-2018 on refund claims after issuance of deficiency memo and re credit of electronic ledger and allowing refunds to exporters who have received capital goods under EPCG to claim refund of IGST paid on exports
- 28) Instruction No. 6/2017-Customs dated 2-06-2017 regarding filing and processing of shipping bills
- 29) Instruction 15/2017-Customs dated 9-10-2017 regarding refund of IGST paid on export of goods under Rule 96
- 30) Instruction No. 16/2017-Customs dated 9-10-2017 regarding refund of IGST paid on export of goods under Rule 96
- 31) Circular 22/2017-Customs dated 30-06-2017 regarding drawback during transition period from 01-07-2017 to 30-09-2017
- 32) Circular 24/2017-Customs dated 30-06-2017 regarding duty drawback for supplies made by DTA Units to SEZ in GST Scenario.
- 33) Circular 26/2017-Customs dated 01-07-2017 regarding export procedures under GST
- 34) Guidance Note for Importers and Exporters w.e.f. 01-07-2017 under GST
- 35) Circular No. 42/2017-Customs dated 7-11-2017 regarding refund of IGST paid on export of goods
- 36) Circular 5/2018-Customs dated 23-02-2018 refund of IGST paid on export regarding mismatch of invoice and alternative mechanism
- 37) Circular 6/2018-Customs dated 16-03-2018 refund of IGST paid on exports regarding EGM error related cases
- 38) Circular 8/2018-Customs dated 23-03-2018 regarding SB005 and SB006 errors in refunds
- 39) Letter F.No.450/35/2018-Cus IV dated 28-03-2018 regarding problems encountered in sanction of refunds
- 40) Circular 12/2018-Customs dated 29-05-2018 regarding sanction of pending IGST refund claims where records have not been transmitted from GSTIN to DG systems
- 41) Circular 15/2018-Customs dated 6-6-2018 clarifications on errors in grant of refund of IGST paid on exports
- 42) Circular 22/2018-Customs dated 18-07-2018 clarification of SB003 and SB005 errors
- 43) Circular 33/2018-Customs dated 19-09-2018 sanction of pending IGST refund claims where records have not been transmitted from GSTIN to DG(System)

- | | |
|-----|---|
| 44) | Circular 35/2018-Customs dated 1-10-2018 Advisory circular for registration of beneficiaries on ICEGATE |
| 45) | Circular 37/2018-Customs dated 9-10-2018 Cases where IGST refund have not been granted due to claiming higher rate of drawback or where higher rate and lower rate were identical |
| 46) | Circular 40/2018-Customs dated 24-10-2018 regarding IGST export refunds revised processing in certain cases including disbursal of compensation cess |
| 47) | Chapter twenty four of the compilation of the GST Flyers as issued by the CBIC on "Zero Rating" |
| 48) | Chapter twenty five of the compilation of the GST Flyers as issued by the CBIC on "Deemed Exports" |
| 49) | Chapter Thirty Four of the compilation of the GST Flyers as issued by the CBIC on 'Refunds under GST' |
| 50) | Chapter Thirty Five of the compilation of the GST Flyers as issued by the CBIC on 'Refund of Integrated Tax paid on account of zero rated supplies' |
| 51) | Chapter Thirty Six of the compilation of the GST Flyers as issued by the CBIC on 'Refund of unutilized Input Tax Credit' |
| 52) | Press Release on blockage of working capital of exporters dated 22-09-2017 |
| 53) | Press Release dated 29-11-2017 on exporters advised to file Table 6A and GSTR-3B for processing of IGST refunds and for refunds of unutilized input tax credit |
| 54) | Changes in duty drawback rates of certain export items effective from 25-01-2018 |
| 55) | Guide on IGST Refunds in ICES issued by DG Systems in Feb 2018 |

Related Provisions of the Statute

Section or Rule	Description
2(39)	Deemed Exports
2(42)	Drawback
17(2)	Taxable supplies include zero rates supplies
25(9)	Registration of UN agencies and notified persons for claiming refund
31(3)(e)	Refund Voucher where no supply is made
42(9)	Refund of Interest paid on acceptance of outward supplies
43(9)	Refund of Interest paid on acceptance of reduction of output tax liability

Section 49(6)	Refund of balance in electronic cash or credit ledger
Section 51(8)	Refund of tax deducted in excess or erroneously
Section 60(5)	Refund of provisionally paid tax
Section 65(7)	Audit of erroneous refund by tax authorities
Section 66(6)	Special Audit of erroneous refund
Section 73,74,75	Demand of erroneous refund
Section 77 of CGST, Section 19 of IGST and section 12 of UTGST	Tax wrongfully collected and paid to Central Government or State Government
122(1)(viii)	Prosecution for fraudulent obtention of refund
132(1)(b)	Prosecution for Issue of invoice resulting wrongful obtention of refund
132(1)(e)	Prosecution for fraudulent obtention of refund
142(1)	Refund of duty paid under existing law on return of goods
147	Deemed Exports
170	Rounding off of Refund

IGST Act

2(5)	Export of Goods
2(6)	Export of Services
7(5)	Inter state supply
11	Place of supply of goods exported out of India
12	Place of supply when location of supplier or location of recipient is outside India.
15	Refund of Integrated tax paid on supply of goods to tourist leaving India
16	Zero Rated Supply

54.1 Introduction

Section 54 deals with the legal and procedural aspects of claiming refund by any person in respect of -

- any tax (which was excess paid);
- interest paid on such tax; or

- any other amount paid (which was not required to be paid);
- tax paid on zero rated supply of goods or services or both i.e. against exports and supplies to SEZ
- tax paid on inputs or input services “used” in the zero rated supply of goods and/or services including exports and supplies to SEZ;
- tax on the supply of goods regarded as deemed exports;
- unutilized input tax credit at the end of tax period in cases of:
 - exports, other than when
 - goods are subjected to export duty.
 - the supplier avails drawback of central tax or claims refund of integrated tax paid on such supplies.
 - input tax rate being higher than output tax rate, other than NIL rated or fully exempted.
- Supply which is not provided, either wholly or partially and for which invoice has not been issued or refund voucher has been issued.
- CGST and SGST paid for transaction HELD to be Inter-state transaction or IGST paid for transaction HELD to be Intra state transaction
- Refund to Casual Taxable Person/ Non Resident Taxable Person (subject to furnishing all returns for the period of currency of registration)

This section provides for conditions and procedures for claiming refund without specifying all the circumstances in which the refund will be eligible to an applicant. Some Other circumstances where refund may be granted but are not covered by section 54 may be as follows:

- a. Refund of duty/tax under existing law
- b. Refund in case of International Tourist
- c. Refund of Provisionally paid tax
- d. Refund of Compensation Cess
- e. Refund on account of Excess or Erroneous Deduction
- f. Refund on Inward Supplies to Canteen Stores Department
- g. Refund to Inward Supplies to UN and agencies
- h. Refund of Interest against restoration of ITC
- i. Refund of Interest against restoration of reduction in output tax liability

- j. Refund due to order of Appellate Authority/Court
- k. Refund of Central share in CGST & IGST in hilly areas
- l. Refund of tax under Seva Bhoj Yojna

Thus, it can be inferred that refund is possible only when

- a) tax, interest or any other amounts are physically paid in cash and
- b) in respect of exports / SEZ supplies/inverted duty rate in the form of input tax.

54.2 Analysis

- (i) This provision states that the application for refund shall be made before the expiry of two years from the relevant date. The definition of relevant date in different circumstances is discussed here. It is important to note that section 54 operates not only as the machinery provision for disbursement of refund arising under provisions such as section 55 of CGST Act, 16 of IGST Act among others, section 54 is also a substantive provision vesting the Registered Person with right to claim refund, for example, section 54(3). While it plays these roles, it also effectively bars any other avenue for claiming refund. This bar operates by not listing any residual provision for claiming refund. Conspicuous by its absence is the provision to claim refund of unutilized credit when a registration is being cancelled where there is still some credit remaining after satisfying credit reversal requirements under section 29(5). This is a significant aspect to note, that there is no residual avenue to claim refund in 'any other cases' in section 54.
- (ii) In case of taxable person claiming refund of any balance in the electronic cash ledger, it can be claimed in the return furnished under section 39.
- (iii) Following persons are entitled to a refund of tax paid by it on inward supplies of goods or services or both –
 - (a) A specialized agency of the United Nations Organization or
 - (b) Any Multilateral Financial Institution and Organization notified under the United Nations (Privileges and Immunities) Act, 1947,
 - (c) Consulate or Embassy of foreign countries or
 - (d) any other person or class of persons as notified under section 55.

Such agencies may make an application for refund, in such specified form and manner as may be prescribed within six months from the end of the quarter in which such supply was received. (Vide **Notification No. 20/2018 – Central Tax dated 28th March, 2018**, the Government has extended the time limit from six months from the end of the quarter to eighteen months from the last date of the quarter in which such supply was received)

- (iv) Refund of the unutilized input tax credit can be claimed at the end of any tax period in the following cases:

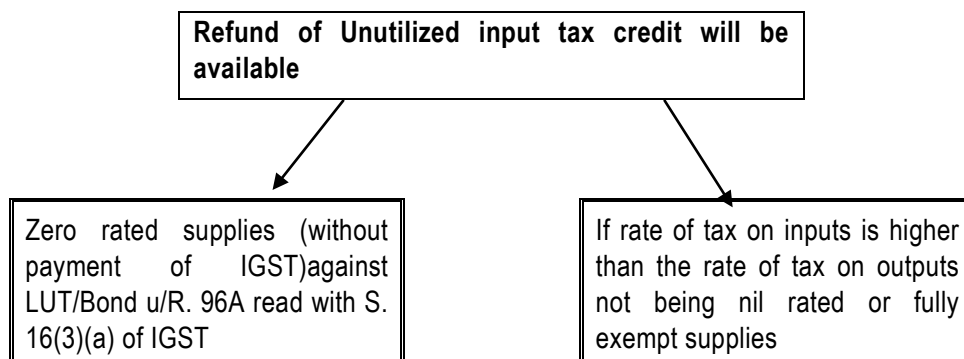

However, refund on zero rated supplies is also not eligible in the following cases:

- (a) If the goods exported out of India are subject to export duty;
- (b) If supplier claims refund of output tax paid under IGST Act.
- (c) If the supplier avails duty drawback of IGST/CGST on such supplies.

The manner of calculation of refund amount in case of refund of unutilized ITC in case of zero rated supplies and inverted duty rate is provided in Rule 89(4) and Rule 89(5) and the details are discussed in Para 54.6

Note : In terms of Circular No. 45/19/2018 dated 30.05.2018, it has been clarified that in case of a registered persons making zero-rated supply of aluminum products on payment of integrated tax but who cannot utilize the credit of the compensation cess paid on coal for payment of integrated tax in view of the proviso to section 11(2) of the Cess Act, which allows the utilization of the input tax credit of cess for the payment of cess on the outward supplies only, then, they cannot claim refund of compensation cess in case of zero-rated supply on payment of integrated tax. However, refund of unutilized credit including compensation cess on coal can be claimed.

Note: Drawback during transition period from 01-07-2017 to 30-09-2017

In order to ensure smooth transition to the GST regime, Government allowed the old Duty Drawback scheme to continue for a period of three months i.e. from 1.7.2017 to 30.9.2017. The exporters could, for exports made during this period, continue to claim the composite rates subject to certain additional conditions. During the transition period, exporters could also claim Brand rate of duty/tax incidence as they have been doing earlier. The conditions imposed for claiming these composite rates aimed to ensure that the exporters do not claim composite AIRs of duty drawback and **simultaneously avail input tax credit of Central Goods and Services Tax (CGST) or Integrated Goods and Services Tax (IGST) on the export goods or on inputs and input services used in manufacture of export goods or claim refund of IGST paid on export goods.**

Further, an exporter claiming composite rate shall also be barred to carry forward Cenvat credit on the export goods or on inputs or input services used in manufacture of export goods in terms of the CGST Act, 2017. The exporters were, however required to give a declaration and certificates at the time of export. Similar checks shall apply while determining the Brand rate of drawback. While a transition period of three months had been allowed, the exporters had an option to claim only Customs portion of AIRs of duty drawback of the Schedule of AIRs of duty drawback and avail input tax credit of CGST or IGST or refund of IGST paid on exports. [Circular 22/2017-Customs dated 30-06-2017]

Note: Drawback allowed for certain duties/taxes

A supplier availing of drawback only with respect to basic customs duty shall be eligible for refund of unutilized input tax credit of central tax/State tax/Union territory tax/integrated tax/compensation cess under the said provision. It is further clarified that refund of eligible credit on account of State tax shall be available even if the supplier of goods or services or both has availed of drawback in respect of central tax.[Circular 37/11/2018 dated 15-03-2018 Para 2.1]

- (v) The application for refund should be accompanied by the documents which clearly establish that refund is due to applicant. These documents are prescribed by Rule 89(2), and details are discussed in Para 54.4
- (vi) Further the applicant is required to furnish documents and other evidences to establish that
 - (a) Amount of tax and interest, if any, paid on such tax or any other amount paid in relation to which such refund is claimed was **collected from him** or (e.g. Purchase Invoices, Electronic Credit ledger, Returns)**OR**
 - (b) Amount of tax and interest, if any, paid on such tax or any other amount paid in relation to which such refund is claimed was **paid by him** or (e.g. Sale Invoices, Electronic Cash Ledger, Challas for payment of tax, returns offsetting liability etc.)

The applicant is also required to establish with the help of documentary and other evidence that the incidence of such tax and interest had not been passed on to any other person.
- (vii) If the amount of refund claim is less than rupees 2 lakh, it shall not be necessary for the applicant to furnish any documentary and other evidences bust self-declaration based on documentary and other evidences available with the claimant, certifying that he has not passed on the incidence of such tax and interest would suffice to claim refund.

As per **section 49(9)** Every person who has paid the tax on goods or services or both under this Act shall, **unless the contrary is proved by him**, be deemed to have

passed on the full incidence of such tax to the recipient of such goods or services or both.

As per **Explanation (ii) to Rule 89(2)**, where the amount of tax has been recovered from the recipient, it shall be deemed that the incidence of tax has been passed on to the ultimate consumer.

- (viii) The refund relating to an application if found complete in all respects, will be sanctioned within sixty days from the date of receipt of application.
- (ix) The refund will be sanctioned to the claimant, in the following cases –
- refund of tax paid on export of goods or services or both
 - refund of tax on inputs or input services used in making exports
 - refund of unutilized input tax credit accumulated on account of inverted duty structure;
 - the tax / interest / other amounts paid by the applicant, if he had not passed on the incidence of tax to any other person; or
 - refund of tax paid on a supply which is not provided, either wholly or partially, and for which invoice has not been issued or where a refund voucher has been issued
 - refund of tax in pursuance of section 77 which means a registered person who has paid CGST and SGST/UTGST on a transaction considered by him as INTRA-STATE supply but held to be INTER-STATE supply;
 - the tax or interest borne by notified class of applicants (done by Central/State Government on the recommendation of the council);

The above categories of refunds shall be paid to the applicant and shall not go to consumer welfare fund irrespective of the fact there is contrary

- (a) Judgment , Decree, Order or direction of appellate Tribunal or any court
- (b) Provision in the CGST Act
- (c) Rule made under CGST Act
- (d) Law for the time being in force

Barring above cases, the refund amount shall be credited to consumer welfare fund and refund shall not be granted to the applicant. Hence it is important for applicant to establish that his refund application falls under any of above categories.

- (x) In case of refund claimed is on account of zero rated supply of goods and/or services, the proper officer may refund, on provisional basis, ninety percent of the total amount claimed (**excluding input tax credit not yet finalized**). This refund of 90% will be on a provisional basis, and will be subject to conditions, limitations and safeguards. Remaining 10% may be refunded after due verification of documents furnished by the applicant.

Note: As per **Rule 91**, provisional refund shall be granted subject to the condition that the person claiming refund has, during any period of five years immediately preceding the tax period to which the claim for refund relates, not been prosecuted for any offence under the Act or under an erstwhile law where the amount of tax evaded exceeds two hundred and fifty lakh rupees.

As per Para 7 of **Circular 37/11/2018 dated 15-03-2018**, The facility of export under LUT is available to all exporters in terms of notification No. 37/2017- Central Tax dated 4th October, 2017, except to those who have been prosecuted for any offence under the CGST Act or the IGST Act or any of the existing laws in force in a case where the amount of tax evaded exceeds two hundred and fifty lakh rupees. Para 2(d) of the Circular No. 8/8/2017-GST dated 4th October, 2017, mentions that a person intending to export under LUT is required to give a self-declaration at the time of submission of LUT that he has not been prosecuted. Persons who are not eligible to export under LUT are required to export under bond. It is clarified that this requirement is already satisfied in case of exports under LUT and asking for self-declaration with every refund claim where the exports have been made under LUT is not warranted

Note: The proper officer, after scrutiny of the claim and the evidence submitted in support thereof and on being prima facie satisfied that the amount claimed as refund is due to the applicant then he shall make an order in FORM GST RFD-04, sanctioning the amount of refund due to the said applicant on a provisional basis within a period not exceeding seven days from the date of the acknowledgement under sub-rule (1) or sub-rule (2) of rule 90 (refer para 54.10) i.e. RFD-02.

Note: Also, the proper officer shall issue a payment advice in FORM GST RFD-05 for the amount sanctioned and the same shall be electronically credited to any of the bank accounts of the applicant mentioned in his registration particulars and as specified in the application for refund.

Note: As per **Circular 24/24/2017-GST dated 21-12-2017**, it has been decided by the competent authority to sanction refund of provisionally accepted input tax credit at this juncture. However, the registered persons applying for refund must give an undertaking to the effect that the amount of refund sanctioned would be paid back to the Government with interest in case it is found subsequently that the requirements of clause (c) of sub-section (2) of section 16 read with sub-section (2) of sections 42 of the CGST Act have not been complied with in respect of the amount refunded. This undertaking should be submitted manually along with the refund claim till the same is available in FORM RFD-01A on the common portal.

- (xi) In case of claim of refund of accumulated unutilized input tax credit for zero rated supply or inverted duty rate, the refund due will be either withheld or deducted in cases where –

- A person defaults in furnishing any return;
 - A person is required to pay any tax, interest or penalty ordered, which is not stayed by Court or Appellate Authority within the last date for filing an appeal under this act.
- (xii) The deduction from refund due may be tax, interest, penalty, fee or any other amount which remains unpaid under
- (a) GST Act or
 - (b) erstwhile law.
- (xiii) In cases where the refund is a consequence of an order and such order is in –
- appeal; or
 - further proceeding; or
 - Where any other proceeding under this Act is pending

And the Commissioner is of the opinion that grant of refund would affect the revenue adversely in the appeal or proceeding on account of malfeasance or fraud committed, the Commissioner may withhold the refund till such time as it may be determined. This can be done only after affording the taxable person an opportunity of being heard.[S. 54(11)]

The Government vide **Notification No. 13/2017- Central Tax dated 28-06-2017** has prescribed, on the recommendation of the Council, 6% as the rate of interest for a refund withheld under sub-section (11) of section 54.

- (xiv) The amount of advance tax deposited by a casual taxable person or a non-resident taxable person at the time of taking registration would be refunded only after furnishing all the returns required under section 39, of the entire period for which the certificate of registration granted to him had remained in force.

Note: As per **Rule 89**, refund of any amount, after adjusting the tax payable by the applicant casual taxable person or non-resident taxable person out of the advance tax deposited by him at the time of registration, shall be claimed in the last return required to be furnished by him

- (xv) No refund shall be granted or paid to an applicant or consumer welfare fund, whether it is final refund or provisional refund (provisional refund is granted in case of refund of unutilized ITC against zero rated supplies) if the amount is less than rupees one thousand. As per Para 8.2 of Circular 59/2018 dated 4-9-18, limit of rupees one thousand shall be applied for each tax head separately and not cumulatively. The limit would not apply in cases of refund of excess balance in the electronic cash ledger. Officers have been directed to reject claims of refund from the electronic credit ledger

for less than one thousand rupees and recredit such amount by issuing an order in FORM GST RFD-01B.

- (xvi) The Government vide **Notification No. 20/2018- Central Tax (Rate) dated 26-07-2018** has allowed for refund of accumulated input tax credit on account of inverted duty structure on fabrics variants (10 categories of fabrics) which was earlier restricted and not available for such benefit. This allowance of refund becomes effective from date of August 1, 2018, with a condition that the balance of accumulated input tax credit lying unutilized upto the month of July 2018 shall lapse. Thus, refund of inverted duty structure is available for the 10 variants of fabrics from August 1, 2018 and hence the Input tax credit on procurements prior to this effective date is to be reversed as refund for such credit was not available.

The Government has clarified that the restriction is applicable only for input tax credit on goods, the said restriction does not apply on input tax credit on input services and capital goods. (Circular no 56/2018 dated 24.08.2018)

Relevant date: The relevant date is crucial to determine the time within which the refund claim has to be filed. If the refund claim is made after the relevant date, the refund claim would be rejected and there is no provision in the Act to condone the delay in filing refund claim and accept delayed refund claims.

The relevant date is identified as follows:

- Refund of tax paid on goods exported or tax paid on inputs/input service
 - If exported by sea or air ->date when the ship or the aircraft leaves India; or
 - If exported by land ->date when such goods pass the Customs frontier; or
 - If exported by post ->date of dispatch of goods by concerned Post Office to a place outside India.
- Deemed exports supply of goods->the date on which the return relating to such deemed exports is furnished.
- Refund of tax paid on such services exported itself or tax paid on inputs/input service
 - If supply of service is completed prior to the receipt of payment->date of receipt of payment in convertible foreign exchange or in Indian rupees where ever permitted by RBI;
 - If payment for the service received in advance prior to the date of issue of invoice -> date of issue of invoice.
- Refund of tax as a consequence of judgment, decree, order or direction of Appellate authority, Appellate Tribunal or any Court -> date of communication of such judgement/decreed/order/ direction.

- Refund of unutilized input tax credit accumulated due to inverted duty rate—due date for furnishing return for the tax period in which such claim for refund arises;
- Provisionally paid tax - the date of adjustment of tax after the final assessment.
- In the case of a person, other than the supplier, the date of receipt of goods or services or both by such person; and
- In any other case, the date of payment of tax

To summarise the above:

Situation of Refund	2 years from the Relevant Date as under
On account of excess payment	Date of payment of tax
On account of Export of Goods by Sea or Air	Date on which Ship or Air craft in which goods are loaded, <u>leaves India</u>
On account of Export of Goods by Land	Date on which goods <u>pass</u> the customs frontiers of India
On account of Export of Goods by	Date of <u>despatch</u> of goods by <u>post office concerned to a place outside India.</u>
On account of Export of Services before payment	Date of <u>receipt</u> of convertible foreign exchange or India rupees, where permitted by RBI.
Export of service against advance payment	Date of <u>issue of invoice</u>
On account of deemed exports	Date of <u>filing return</u>
On account of finalization of provisional assessment	Date of the <u>adjustment</u> of the tax after the final assessment.
In pursuance of an order in favour of the taxpayer by the Appellate Authority/ Appellate Tribunal / Court	Date of <u>communication</u> of the judgement/order/direction
On account of accumulated unutilised input tax credit of GST under inverted duty	Due date of furnishing of return for the period in which claim for refund arises
Claim of refund by a person not being a supplier, [e.g. UIN Holder or recipient claiming refund for deemed exports u/R 89(1) clause(a) to 3 rd Proviso]	Date of receipt of goods or services by such person or UIN holder
Claim of refund by a Casual/Non-resident taxable person	Relevant date is Date of payment of tax. But refund to be claimed in last return to be furnished by casual/non resident taxable person

54.3 Manner and Timing of Refund

Rule 89(1) facilitates a taxable person to claim refund in following manner under various circumstances

S.No.	Scenarios	Manner to claim refund
1	Refund of any tax, interest, penalty, fees or any other amount paid	File an application electronically in FORM GST RFD-01 through the common portal. Till RFD-01 is available on the portal, Form GST RFD-01A (as per Rule 97A) to be used for filing of refunds manually.
2	Refund relating to balance in the electronic cash ledger in accordance with the provisions of sub-section (6) of section 49	Such a refund may be made through the return furnished for the relevant tax period in FORM GSTR-3 or FORM GSTR-4 or FORM GSTR-6 or FORM GSTR-7

Note: In terms of Notification No. 55/2017 – Central Tax dated 15th November 2017, Rule 97A has been inserted in the Central Goods and Service Tax Rules, 2017 providing for manual filing of refund application and its processing. As per Rule 97A, any reference to electronic filing of an application, intimation, reply, declaration, statement or electronic issuance of a notice, order or certificate on the common portal shall, in respect of that process or procedure, include manual filing of the said application, intimation, reply, declaration, statement or issuance of the said notice, order or certificate in such Forms as appended to these rules.

In other words, the refunds may be filed manually and the processing of refund with respect to any notice, reply or order, among others, can also be issued / filed manually.

Note:

Frequency of filing refund application

As per Circular 24/2017 dated 21-12-17, that refund claims in respect of zero-rated supplies and on account of inverted duty structure, deemed exports and excess balance in electronic cash ledger shall be filed for a tax period on a monthly basis in FORM GST RFD-01A. However, in case registered persons having aggregate turnover of up to Rs.1.5 crore in the preceding financial year or the current financial year are opting to file FORM GSTR-1 quarterly (notification No. 57/2017-Central Tax dated 15.11.2017 refers), such persons shall apply for refund on a quarterly basis.

In case of casual taxable person and non-resident taxable person, refund of any amount, after adjusting the tax payable by the applicant out of the advance tax deposited by him under at the time of registration, shall be claimed in the last return required to be furnished by him.

Hence casual taxable person or non-resident taxable person need not file monthly or quarterly refunds and has to file refund only in last of his returns.

As per Circular 37/2018 dated 15-03-2018, Para 11.2:

- a) Exporter, at his option, may file refund claim for one calendar month / quarter or by clubbing successive calendar months / quarters
- b) The calendar month(s) / quarter(s) for which refund claim has been filed, however, cannot spread across different financial years

Refund to be claimed after filing of returns applicable to claimant

As per **Circular 24/2017 dated 21-12-17**[Para 2], refund claim for a tax period may be filed only after filing the details in FORM GSTR-1 for the said tax period. It is also to be ensured that a valid return in FORM GSTR-3B has been filed for the last tax period before the one in which the refund application is being filed.

However, In terms of **Circular No. 45/19/2018 dated 30.05.2018**, Para 3.3, it has been clarified that for an Input Service Distributor or a non-resident taxable person or a person paying tax under the provisions of section 10 or section 51 or section 52, the return as filed by them in terms of the rules applicable to them, i.e. FORM GSTR-4 for a composition taxpayer, FORM GSTR-6 for an ISD and FORM GSTR-5 for a non-resident taxable person shall be sufficient instead of filing of the details in FORM GSTR 1 & FORM GSTR 3B.

Refund for supplies to SEZ to be filed after endorsed for authorized operation

In respect of supply of goods to SEZ Unit/Developer application for refund shall be filed after such goods have been admitted in full in SEZ for authorized operations. An endorsement by the specified officer of the SEZ is required as evidence of admission of goods in full for authorized operations.

In respect of supply of services to SEZ Unit/Developer application for refund shall be filed after evidence regarding receipt of services for authorised operations has been endorsed by the specified officer of the SEZ.

Note:

The above discussion does not include:

- a) The manner of filing refund application for refund of IGST paid on zero rated supplies, which are discussed in Para 54.7
- b) The manner of filing refund application by person covered by section 55, which is discussed in Para 55.

Refund Application of IGST for supplies to SEZ to be filed only after matching of tax payment between GSTR 3B and GSTR-1

While filing the return in **FORM GSTR-3B** for a given tax period, certain registered persons committed errors in declaring the export of services on payment of integrated tax or zero rated

supplies made to a Special Economic Zone developer or a Special Economic Zone unit on payment of integrated tax. They have shown such supplies in the Table under column 3.1(a) instead of showing them in column 3.1(b) of **FORM GSTR-3B** whilst they have shown the correct details in Table 6A or 6B of **FORM GSTR-1** for the relevant tax period and duly discharged their tax liabilities. Such registered persons are unable to file the refund application in **FORM GST RFD-01A** for refund of integrated tax paid on the export of services or on supplies made to a SEZ developer or a SEZ unit on the GST common portal because of an in-built validation check in the system which restricts the refund amount claimed (integrated tax/cess) to the amount of integrated tax/cess mentioned under column 3.1(b) of **FORM GSTR-3B** (zero rated supplies) filed for the corresponding tax period. In this regard, it is clarified that for the tax periods commencing from 01.07.2017 to 31.03.2018, such registered persons shall be allowed to file the refund application in **FORM GST RFD-01A** on the common portal subject to the condition that the amount of refund of integrated tax/cess claimed shall not be more than the aggregate amount of integrated tax/cess mentioned in the Table under columns 3.1(a), 3.1(b) and 3.1(c) of **FORM GSTR-3B** filed for the corresponding tax period. **[Para 4.1,4.2 of Circular 45/19/2018-GST dated 30-05-2018]**

54.4 Documentary Evidences:

As per section 54(4)(a), application for refund should be accompanied by documentary evidence to establish that refund is due to the applicant. The documents in this regard are prescribed in Rule 89(2). As per Rule 89(2) the above application(s) shall be accompanied by following documentary evidences to establish that refund is due to the applicant

S.No.	Scenarios	Documents
1	Refund of Pre-deposit as per sub-section (6) of section 107 and sub-section (8) of section 112 [Pre deposit is made for entertaining the appeal against the order]	Reference number of the order <u>and</u> a copy of the order passed by the proper officer or an appellate authority or Appellate Tribunal or court resulting in such refund or OR Reference number of the payment of the pre-deposit amount.
2	Refund on account of export of goods	A statement containing the number and date of shipping bills or bills of export and the number and the date of the relevant export invoices. Note: Insistence on proof of realization of export proceeds for processing of refund claims related to export of goods has not been envisaged in the law and should not be insisted upon [Para 12 of Circular 37/11/2018-GST dated 15-03-2018]
3	Refund on account of export of services	A statement containing the number and date of invoices and the relevant Bank Realisation

		Certificates or Foreign Inward Remittance Certificates				
4	Refund on account of supply of goods made to a Special Economic Zone unit or a Special Economic Zone developer	<p>A statement containing the number and date of invoices as provided in rule 46 along with the evidence regarding the endorsement by the specified officer of the Zone</p> <p>A declaration to the effect that the Special Economic Zone unit or the Special Economic Zone developer has not availed the input tax credit of the tax paid by the supplier of goods or services or both, in a case where the refund is on account of supply of goods or services made to a Special Economic Zone unit or a Special Economic Zone developer</p>				
5	Refund on account of supply of Service made to a Special Economic Zone unit or a Special Economic Zone developer	<p>A statement containing the number and date of invoices, the evidence regarding the endorsement specified in the second proviso to sub-rule (1) and the details of payment, along with the proof thereof, made by the recipient to the supplier for authorised operations as defined under the Special Economic Zone Act, 2005, in a case where the refund is on account of supply of services made to a Special Economic Zone unit or a Special Economic Zone developer</p> <p>A declaration to the effect that the Special Economic Zone unit or the Special Economic Zone developer has not availed the input tax credit of the tax paid by the supplier of goods or services or both, in a case where the refund is on account of supply of goods or services made to a Special Economic Zone unit or a Special Economic Zone developer</p>				
6	Refund on account of deemed exports (where refund is claimed by the Supplier)	<p>A statement containing the number and date of invoices along with the following documents notified under Notification No. 49/2017 – Central Tax dated 18th October, 2017:</p> <p>(a) Proof of receipt of Goods by the Eligible Recipient:</p> <table border="1"> <thead> <tr> <th>In case of Supply to</th> <th>Document required</th> </tr> </thead> <tbody> <tr> <td>Advance Authorisation</td> <td>Acknowledgment that Holder has received</td> </tr> </tbody> </table>	In case of Supply to	Document required	Advance Authorisation	Acknowledgment that Holder has received
In case of Supply to	Document required					
Advance Authorisation	Acknowledgment that Holder has received					

		Holder or EPCG Holder	the goods should be obtained from the jurisdictional Tax officer having jurisdiction over the said Holder,
		EOUs	Copy of the tax invoice under which such supplies have been made by the supplier, duly signed by the recipient Export Oriented Unit that said deemed export supplies have been received by it
			(b) Undertaking from the Recipient of the Deemed Export that the Recipient has not taken Input Tax Credit of the GST paid by the Supplier (c) Undertaking from the Recipient of the Deemed Export that they shall not claim the refund of the GST paid by the Supplier.
7	Refund on account of deemed exports (where refund is claimed by the Recipient of Deemed Exports)		A statement containing the number and date of invoices along with further documents as may be notified. However, no documents has been notified by the Government when the Recipient is claiming the Refund. It may be prudent for the Recipient to obtain an undertaking from the Supplier that Supplier has not claimed refund of the GST paid on the Deemed Exports
8	Refund on account of the rate of tax on the inputs being higher than the rate of tax on output supplies, other than nil-rated or fully exempt supplies		A statement containing the number and the date of the invoices received and issued during a tax period in a case where the claim pertains to refund of any unutilised input tax credit under sub-section (3) of section 54
9	Refund arises on account of the finalisation of provisional assessment		The reference number of the final assessment order and a copy of the said order

10	Refund as per Section 77 (tax wrongly collected and paid to Central or state government)	A statement showing the details of transactions considered as intra-State supply but which is subsequently held to be inter-State supply
11	Refund claimed does not exceed two lakh rupees (tax paid but the incidence has not been passed on to the other person)	A declaration to the effect that the incidence of tax, interest or any other amount claimed as refund has not been passed on to any other person
12	Refund claimed exceed two lakh rupees (tax paid but the incidence has not been passed on to the other person)	A Certificate in Annexure 2 of FORM GST RFD-01 issued by a chartered accountant or a cost accountant to the effect that the incidence of tax, interest or any other amount claimed as refund has not been passed on to any other person
<p>Self-Declaration or CA Certificate for non-passing on of incidence of tax, interest or any other amount is not required in following cases:</p> <ol style="list-style-type: none"> 1. Refund of tax paid on account of export of goods or services 2. Refund of unutilized ITC for export of goods or inverted duty rate structure. 3. Refund of tax paid on a supply which has not been provided. 4. Refund of CGST and SGST HELD to be IGST or vice versa 5. Refund of Tax or Interest borne by notified applicants. 		

Documents required in case of export of goods:

<p>As per Para 14.2 of Circular 37/11/2018 dated 15-03-2018, List of documents required for processing refund claim on export of goods or services without payment of tax</p> <ul style="list-style-type: none"> ○ Copy of FORM RFD-01A filed on common portal ○ Copy of Statement 3A of FORM RFD-01A generated on common portal ○ Copy of Statement 3 of FORM RFD-01A ○ Invoices w.r.t. input and input services ○ BRC/FIRC for export of services ○ Undertaking / Declaration in FORM RFD-01A <p>List of Documents required for processing of refund claim of Export of Services with payment of tax</p> <ul style="list-style-type: none"> ○ Copy of FORM RFD-01A filed on common portal ○ Copy of Statement 2 of FORM RFD-01A ○ Invoices w.r.t. input, input services and capital goods ○ BRC/FIRC for export of services

o Undertaking / Declaration in FORM RFD-01A

Note: Hence as per Circular 37/11/2018 dated 15-03-2018, Invoices relating to inputs, input services and capital goods were to be submitted for processing of claims for refund of integrated tax where services are exported with payment of integrated tax; and invoices relating to inputs and input services were to be submitted for processing of claims for refund of input tax credit where goods or services are exported without payment of integrated tax. However **As per Circular 59/33/2018 dated 04-09-2018, Para 2.3:** Refund claim shall be accompanied by a print-out of FORM GSTR-2A of the claimant for the relevant period for which the refund is claimed. The proper officer shall rely upon FORM GSTR-2A as an evidence of the account of the supply by the corresponding supplier in relation to which the input tax credit has been availed by the claimant. It may be noted that there may be situations in which FORM GSTR-2A may not contain the details of all the invoices relating to the input tax credit availed, possibly because the supplier's FORM GSTR-1 was delayed or not filed. In such situations, the proper officer may call for the hard copies of such invoices if he deems it necessary for the examination of the claim for refund. It is emphasized that the proper officer shall not insist on the submission of an invoice (either original or duplicate) the details of which are present in FORM GSTR-2A of the relevant period submitted by the claimant.

The claimant shall also submit the details of the invoices on the basis of which input tax credit had been availed during the relevant period for which the refund is being claimed, in the **format enclosed as Annexure-A manually** along with the application for refund claim in FORM GST RFD-01A and the Application Reference Number (ARN). The claimant shall also declare the eligibility or otherwise of the input tax credit availed against the invoices related to the claim period in the said Annexure for enabling the proper officer to determine the same.

Annexure A:

S. No.	GS TIN of Supplier	Name of Supplier	Invoice Details			Type	Central Tax	State Tax/ Union Territory Tax	Integrated Tax	Ces	Eligible for ITC	Amount of Eligible ITC
			Invoice No.	Date	Value							
1	2	3	4	5	6	7	8	9	10	11	12	13

54.5 Refund Amount to be debited to Electronic Credit Ledger

As per Rule 89(3), where the application relates to refund of input tax credit, the electronic credit ledger shall be debited by the applicant by an amount equal to the refund so claimed. As per **Circular 59/33/2018 dated 4-09-2018**, the amount to be debited to electronic credit ledger is least of the following:

- a) Amount calculated as per Rule 89(4) or 89(5)
- b) The balance in the electronic credit ledger of the claimant at the end of the tax period for which the refund claim is being filed after the return for the said period has been filed; and
- c) The balance in the electronic credit ledger of the claimant at the time of filing the refund application.

After calculating the least of the three amounts, as detailed above, the equivalent amount is to be debited from the electronic credit ledger of the claimant in the following order:

- a) Integrated tax, to the extent of balance available;
- b) Central tax and State tax/Union Territory tax, equally to the extent of balance available and in the event of a shortfall in the balance available in a particular electronic credit ledger (say, Central tax), the differential amount is to be debited from the other electronic credit ledger (i.e., State tax/Union Territory tax, in this case).

The procedure described above, however, is not presently available on the common portal. Till the time such facility is made available on the common portal, the taxpayers are advised to follow the order as explained above for all refund applications filed after the date of issue of this Circular. However, for applications already filed and pending with the tax authorities, where this order is not adhered to by the claimant, no adverse view may be taken by the tax authorities. The above system validations are being clarified so that there is no ambiguity in relation to the process through which an application in FORM GST RFD-01A is generated. Further, it may be noted that the refund application can be filed only after the electronic credit ledger has been debited in the manner specified above, and the ARN is generated on the common portal

54.6 Formula for computation of refund

Computation of Refund of Unutilized ITC on Export

As provided in Rule 89(4)& Rule 89(5) is as under:

- (a) In the case of zero-rated supply of goods or services or both **without payment of tax under bond or letter of undertaking**, refund of input tax credit shall be granted as per the following formula (for the procedure, refer para 54.8) -

Refund Amount = (Turnover of zero-rated supply of goods + Turnover of zero-rated supply of services) x Net ITC ÷ Adjusted Total Turnover

(A) "Refund amount" means the **maximum refund** that is admissible

(B) "Net ITC" means input tax credit availed on **inputs and input services** during the relevant period **other than** the input tax credit availed for which refund is claimed under sub-rules (4A) or (4B) or both;

Note: ITC on capital goods shall not qualify as Net ITC

(C) "Turnover of zero-rated supply of goods" means the value of zero-rated supply of goods made during the relevant period without payment of tax under bond or letter of undertaking, **other than** the turnover of supplies in respect of which refund is claimed under sub-rules (4A) or (4B) or both;

(D) "Turnover of zero-rated supply of services" means the value of zero-rated supply of services made without payment of tax under bond or letter of undertaking, calculated in the following manner, namely:-

Zero-rated supply of services is the aggregate of the payments received during the relevant period for zero-rated supply of services and zero-rated supply of services where supply has been completed for which payment had been received in advance in any period prior to the relevant period reduced by advances received for zero-rated supply of services for which the supply of services has not been completed during the relevant period;

(E) – Adjusted Total Turnover || means the sum total of the value of-

- (a) the turnover in a State or a Union territory, as defined under clause (112) of section 2, excluding the turnover of services; and
- (b) the turnover of zero-rated supply of services determined in terms of clause (D) above and non-zero-rated supply of services,

excluding-

- (i) the value of exempt supplies other than zero-rated supplies; and
- (ii) the turnover of supplies in respect of which refund is claimed under sub-rule (4A) or sub-rule (4B) or both, if any, during the relevant period

Note: Turnover of zero rated supply of services on which tax has been paid has been excluded from the definition of adjusted turnover by Notification 39/2018-Central Tax dated 04-09-2018. Zero rated supply of service without payment of tax and non-zero rated supply of service, however, shall form part of adjusted turnover.

(F) – Relevant period|| means the period for which the claim has been filed

Computation of Refund of Inverted Duty Structure

- (c) In the case of refund on account of **inverted duty structure**, refund of input tax credit shall be granted as per the following formula –

Maximum Refund Amount = {(Turnover of inverted rated supply of goods and services) x Net ITC ÷ Adjusted Total Turnover} - tax payable on such inverted rated supply of goods and services.

- (a) Net ITC shall mean input tax credit availed **on inputs** during the relevant period other than the input tax credit availed for which refund is claimed under sub-rules (4A) or (4B) or both; and
- (b) Adjusted Total turnover shall have the same meaning as assigned to it in sub-rule (4).

Note: In terms of **Notification 21/2018** – Central Tax dated 18th April 2018,

- (i) Maximum refund amount to be computed after taking into consideration the ITC availed on inputs only. No refund shall be allowed on inputs services in case of refunds under inverted duty rate. Before amendment by Notification 21/2018, the definition of Net ITC as applicable under Rule 89(4) was applicable to inverted duty rated refunds, which included ITC on inputs as well as input services.
- (ii) Further, Refund shall be allowed on turnover of goods as well as services. Before amendment by Notification 21/2018, the formula provided for refund in respect of turnover of inverted duty rated goods only.

Notification **26/2018 dated 13-06-2018**, further reiterated the above amendments in formula for inverted duty rated refunds and also made it applicable retrospectively w.e.f. 01-07-2017.

Note: Notification No. 5/2017-Central Tax (Rate) dated 28.06.2017 (as modified by 29/2017-Central Tax(Rate) dated 22-09-2017 and 44/2017-Central Tax (Rate) dated 14-11-2017) specifies the goods in respect of which refund of unutilized input tax credit (ITC) on account of inverted duty structure under section 54(3) of the CGST Act shall not be allowed where the credit has accumulated on account of rate of tax on inputs being higher than the rate of tax on output supplies of such goods. It includes fabrics items and items related to railways. However, in case of fabric processors (Job worker), the output supply is the supply of job work services and not of goods (fabrics). Hence, in terms of **Circular No 48/22/2018**, it is clarified that the fabric processors (Job Worker) shall be eligible for refund of unutilized ITC on account of inverted duty structure under section 54(3) of the CGST Act even if the goods (fabrics) supplied to them are covered under notification No. 5/2017-Central Tax (Rate) dated 28.06.2017.

Note: **Notification 20/2018-Central Tax (Rate) dated 26-07-2018**, has further amended notification 5/2017-Central Tax (Rate) dated 28-06-2017 to provide that

nothing contained in this notification shall apply to the input tax credit accumulated on supplies received on or after the 1st day of August, 2018, in respect of fabrics. The notification further provides that the accumulated input tax credit lying unutilized in balance, after payment of tax for and upto the month of July, 2018, on the inward supplies received up to the 31st day of July 2018, shall lapse. **Circular 56/30/2018 dated 24-08-2018** has been issued to clarify the doubts relating to lapse of input tax credit accumulated on account of inverted duty structure on fabrics for the period up to 31-07-2018. As per circular for calculation of input tax credit to lapse on 31-07-2018, amount calculated for 01-07-2017 to 31-07-2018, as per formula provided in Rule 89(5) shall be lapsed subject to modifications that ITC in respect of inputs in stock on 31-07-2018 shall be excluded from calculation of net ITC. Calculation of value of inputs shall be made as per format provided in Table 7 of ITC-01. ITC on input services and capital goods shall also not lapse. The amount of credit to lapse shall also not impact the amount of credit refundable of zero rated supplies under Rule 89(4). The amount of credit to lapse shall be provided in column 4B(2) of GSTR-3B return for August 2018. Verification of amount to lapse shall be done at the time of filing first refund on account of inverted duty rated refund on fabric. A detailed calculation sheet shall be prepared by the taxable person and furnished at the time of filing of first refund claim on account of inverted duty structure.

Note: Notification 15/2017 dated 28-6-17 has specified that construction of complex, building, civil structure service where the entire consideration has not been received after issuance of completion certificate as service on which refund not to be allowed under inverted duty rate.

- (d) In the case of zero-rated supply of goods or services or both on **payment of IGST tax**, refund of entire amount of IGST shall be available (refer para 54.7)
- (e) In the case of supplies received on which the supplier has availed the benefit of Notification No. 48/2017-Central Tax dated the 18th October, 2017 (deemed exports), refund of input tax credit, availed in respect of other inputs or input services used in making zero-rated supply of goods or services or both, shall be granted (Rule 89(4A))
- (f) In the case of supplies received on which the supplier of the person claiming refund of unutilized ITC on account of zero rated supplies without payment of tax has availed the benefit of Notification No. 40/2017-Central Tax (Rate) dated the 23rd October, 2017 (concessional rate of tax at 0.05% on intra-State supply of taxable goods by a registered supplier to a registered recipient for export) or Notification No. 41/2017 Integrated Tax (Rate) dated the 23rd October, 2017 (concessional rate of tax at 0.1% on inter-State supply of taxable goods by a registered supplier to a registered recipient for export) or person claiming refund of unutilised input tax credit on account of zero rated supplies without payment of tax himself has availed the benefit of Notification No. 78/2017-Customs dated the 13th October, 2017 (goods imported by EOUs) or Notification No. 79/2017-Customs dated the 13th October, 2017 (import of goods under

Advanced authorization/EPCG schemes) or all of them, refund of input tax credit, availed in respect of inputs received under the said notifications for export of goods and the input tax credit availed in respect of other inputs or input services to the extent used in making such export of goods, shall be granted (Rule 89(4B))

54.7 Rule 96 provides for Refund of integrated tax paid on goods or services exported out of India

It is interesting to note that although Rule 96 reads “Refund of integrated tax paid on goods or **services** exported out of India”, refund of integrated tax paid on the services exported out of India shall be dealt with in accordance with the provisions of rule 89 and the application for refund shall be filed in FORM GST RFD-01. [Rule 96(9)]

Shipping Bill Deemed to be application

The shipping bill filed by an exporter of goods shall be deemed to be an application for refund of integrated tax paid on the goods exported out of India.

When refund application deemed to have been filed

Such application shall be deemed to have been filed only when: -

- the person in charge of the conveyance carrying the export goods duly files an export manifest or an export report covering the number and the date of shipping bills or bills of export; **and**
- the applicant has furnished a valid return in FORM GSTR-3 or FORM GSTR- 3B, as the case may be;

Note: Filing of export manifest is must for treating shipping bill or bill of export as refund claim. Export report is filed in case of export by land and Export manifest is filed in case of export by air or sea. Export manifest is required to be filed u/s 41 and 42 of Customs Act before departure of conveyance carrying goods. Commissioners have to ensure that export report/EGM is filed in prescribed time limits [**Instruction No. 15/2017-Customs dated 09-10-17**]

Transmission of export data to Customs designated portal

The details of the relevant export invoices in respect of export of goods contained in FORM GSTR-1 shall be transmitted electronically by the common portal to the system designated by the Customs and the said system shall electronically transmit to the common portal, a confirmation that the goods covered by the said invoices have been exported out of India. Details of export invoices are available at ICEGATE portal.

Provided that where the date for furnishing the details of outward supplies in FORM GSTR-1 for a tax period has been extended, then in exercise of the powers conferred under section 37 of the Act, the supplier shall furnish the details of information relating to exports as specified in Table 6A of FORM GSTR-1 after the return in FORM GSTR-3B has been furnished and the

same shall be transmitted electronically by the common portal to the system designated by the Customs:

Note that the Table 6A has to be furnished only after filing of Form GSTR-3B under the respective tax period.

Cautions to ensure transmission of Data to Customs designated Portal

Data Matching

To ensure that the GST System transmits the export invoice data, in case of export of goods with payment of IGST, to ICEGATE for refund, Exporters need to provide Complete and Correct Data while filing Table 6A of GSTR-1 as under:

- Invoice No. and Date (Tax invoice and not commercial invoice).
- Select from drop down list (WPAY- with payment of tax)/WOPAY-without payment of tax.
- Shipping Bill No. & Date.
- While using offline tool for GSTR 1, the date format is dd-mmm-yyyy e.g. 15th July 2017 will be written as 15-Jul-2017 and not like 15/07/2017.
- Six Digit Port Code should be mentioned correctly.
- Invoice Value: It is the total value of export goods covered by the invoice including of tax and other charges, if any.
- Taxable Value: It is the value of goods, on which tax is paid. (Value net of tax).
- Tax Paid IGST, only in case, where the export is done on payment of IGST.

Value Differences

Where the value declared in the tax invoice is different from the export value declared in the corresponding shipping bill under the Customs Act, refund claims are not being processed. The value recorded in the GST invoice should normally be the transaction value as determined under section 15 of the CGST Act read with the rules made thereunder. The same transaction value should normally be recorded in the corresponding shipping bill / bill of export. During the processing of the refund claim, the value of the goods declared in the GST invoice and the value in the corresponding shipping bill / bill of export should be examined and the lower of the two values should be sanctioned as refund. **[Para 9.9.1 of Circular 37/11/2018 dated 15-03-2018]**

IGST Paid Differences GSTR-1 and 3B

It is one of validation check by GSTIN that aggregate IGST paid amount claimed in Table 6A of GSTR-1 is not higher than IGST paid amount indicated in Table under column 3.1(b) of GSTR-3B of corresponding month. To ensure that the GST System transmits the export

invoice data, in case of export of goods with payment of IGST, to ICEGATE for refund, Exporters should make payment of Tax and File Return as under:

- i) File Form GSTR-3B of corresponding period.
- ii) In case of export of goods, **the IGST amount paid should be shown through Table 3.1(b) of GSTR-3B and amount must be equal to or greater than the total IGST amount shown in Table 6A, and Table 6B, of GSTR-1 for the corresponding tax period.**

As return in **FORM GSTR-3B** do not contain provisions for reporting of differential figures for past month(s), the said figures may be **reported on net basis along with the values for current month** itself in appropriate tables i.e. Table No. 3.1, 3.2, 4 and 5, as the case may be. It may be noted that while making adjustment in the output tax liability or input tax credit, there can be no negative entries in the FORM GSTR-3B. The amount remaining for adjustment, if any, may be adjusted in the return(s) in FORM GSTR3B of subsequent month(s) and, in cases where such adjustment is not feasible, refund may be claimed. Where adjustments have been made in FORM GSTR-3B of multiple months, corresponding adjustments in FORM GSTR-1 should also preferably be made in the corresponding months. **[Para 4 of Circular 26/26/2017 dated 29-12-17]**

Auto Drafting of GSTR-1

As and when the Form auto-drafted in FORM GSTR-1 are furnished for the said tax period, then details of exports will be auto-drafted from the Table 6A referred above. The procedure is as follows:

- a. File GSTR-3B for a Tax Period
- b. Fill Table 6A of Form GSTR-1 available on the Common Portal. Refund will be processed based on this Table 6A
- c. As and when Form GSTR-1 is filed, the data relating to exports will be auto-populated from the above Table 6A

Processing of IGST Refund Claim

Upon the receipt of the information regarding the furnishing of a valid return in FORM GSTR-3 or FORM GSTR-3B, as the case may be, from the common portal, the system designated by the Customs or the proper officer of Customs, as the case may be shall process the claim of refund in respect of export of goods and an amount equal to the integrated tax paid in respect of each shipping bill or bill of export shall be electronically credited to the bank account of the applicant mentioned in his registration particulars and as intimated to the Customs authorities.

As per Instruction No.15/2017-Customs dated 9-10-17, The amount of refund of IGST paid on export of goods shall be credited to the account of exporter registered with Customs even if it is different from bank account mentioned in registration particulars.

Withholding of Refund of integrated tax paid on exports

- The claim for refund shall be withheld where, -
 - a request has been received from the jurisdictional Commissioner of central tax, State tax or Union territory tax to withhold the payment of refund due to the person claiming refund in accordance with the provisions of sub-section (10) or sub-section (11) of section 54; or the proper officer of Customs determines that the goods were exported in violation of the provisions of the Customs Act, 1962.
 - the proper officer of integrated tax at the Customs station shall intimate the applicant and the jurisdictional Commissioner of central tax, State tax or Union territory tax, as the case may be, and a copy of such intimation shall be transmitted to the common portal
 - the proper officer of central tax or State tax or Union territory tax, as the case may be, shall pass an order in Part B of FORM GST RFD-07
 - Where the applicant becomes entitled to refund of the amount withheld, the concerned jurisdictional officer of central tax, State tax or Union territory tax, as the case may be, shall proceed to refund the amount after passing an order in FORM Part A of GST RFD-06.

Refund of IGST to Government of Bhutan in lieu of Exporter

For notified goods, Central government may pay refund to government of Bhutan instead of exporter. Exporter shall not be allowed any refund of IGST on export of goods to Bhutan.

Restriction on grant of IGST Refund on Exports [R. 96(10)]

Present Rule 96(10) imposing restrictions on grant of refund of IGST on Exports was first introduced as R. 96(9) by Notification 75/2017 dtd 29-12-17 retrospectively from 23-10-17. Then it was re numbered to 96(10) and further amended vide Notification 3/2018 dated 23-01-18 again retrospectively w.e.f. 23-10-17. Then it was re modified vide notification No. 39/2018, dtd. 04.09.2018. w.e.f. 23-10-17. Notifications 53/2018 dated 9-10-18 has modified R. 96(10) from 23-10-17 and notification 54/2018 dated 9-10-18 has amended this Rule prospectively w.e.f. 9-10-18. The impact of changes has been explained in Circular No. 70/44/218-GST dated 26-10-18

From 23-10-17 to 8-10-2018

Exporter who himself/herself imported any inputs/capital goods in terms of notification Nos. 78/2017-Customs [Import by EOU] and 79/2017-Customs(import of goods under Advanced authorization/EPCG schemes) [both dated 13th October, 2017 **shall be eligible** to claim refund of the IGST paid on exports.

However if the benefit of above notifications has been obtained by the supplier of exporter, then exporter shall not be eligible to claim refund of IGST paid on exports. Further if the supplier of exporter has availed benefit of 40/2017-CTR or 41/2017-CTR [Concessional rate of

tax @ 0.05%/0.1% respectively] or 48/2017 [Deemed exports], then also exporter shall not be eligible to claim refund of IGST paid on exports.

From 9-10-2018 and onwards

Exporters who are importing goods in terms of notification Nos. 78/2017-Customs and 79/2017-Customs both dated 13th October, 2017 would not be eligible for refund of IGST paid on exports

However, exporters who are receiving capital goods under the EPCG scheme, either through import in terms of notification No. 79/2017-Customs dated 13th October, 2017 or through domestic procurement in terms of notification No. 48/2017-Central Tax, dated 18th October, 2017, shall continue to be eligible to claim refund of IGST paid on exports and would not be hit by the restrictions.

Further if the person claiming the refund of IGST paid on export of goods or services has availed benefit of 40/2017-CTR or 41/2017-CTR [Concessional rate of tax @ 0.05%/0.1% respectively] or 48/2017 [Deemed exports], then also he shall not be eligible to claim refund of IGST paid on exports.

54.8 Rule 96A provides for Refund of integrated tax paid on export of goods or services under bond or Letter of Undertaking

- Any registered person availing the option to supply goods or services for export without payment of integrated tax shall furnish, prior to export, a bond or a Letter of Undertaking in **FORM GST RFD-11** to the jurisdictional Commissioner (vide circular no 2/2/2017-GST the power has been delegated to Deputy/Assistant Commissioner).

Conditions of LUT

- The registered person shall bind himself to pay the tax due along with the interest specified under sub-section (1) of section 50 (18%) within a period of —
 - (a) fifteen days after the expiry of three months, or such further period as may be allowed by the Commissioner,] from the date of issue of the invoice for export, if the goods are not exported out of India; or
 - (b) fifteen days after the expiry of one year, or such further period as may be allowed by the Commissioner, from the date of issue of the invoice for export, if the payment of such services is not received by the exporter in convertible foreign exchange

The Government has clarified & emphasized that exports have been zero rated under the Integrated Goods and Services Tax Act, 2017 (IGST Act) and as long as goods have actually been exported even after a period of three months, payment of integrated tax first and claiming refund at a subsequent date should not be insisted upon. In such cases, the jurisdictional Commissioner may consider granting extension of time limit for export as provided in the said sub-rule on post facto basis keeping in view the facts and

circumstances of each case. The same principle should be followed in case of export of services. (Circular No. 37/11/2018-GST dated 15th March, 2018)

- In the event, goods are not exported within the time specified above and the registered person fails to pay the IGST amount, the export as allowed under bond or Letter of Undertaking shall be withdrawn forthwith and the said amount shall be recovered from the registered person in accordance with the provisions of section 79.
- The export as allowed under bond or Letter of Undertaking withdrawn shall be restored immediately when the registered person pays the amount due.

The provisions of sub rule (1) shall apply, mutatis mutandis, in respect of zero-rated supply of goods or services or both to a Special Economic Zone developer or a Special Economic Zone unit without payment of integrated tax.”

LUT/Bond not required for exempt supplies

- In terms of Circular No. 45/19/2018 dated 30.05.2018, it has been clarified that in respect of refund claims on account of export of non-GST and exempted goods without payment of integrated tax, LUT/bond is not required. A registered persons exporting **non-GST goods** shall comply with the requirements prescribed under the existing law (i.e. Central Excise Act, 1944 or the VAT law of the respective State) or under the Customs Act, 1962, if any. Further, the exporter would be eligible for refund of unutilized input tax credit of central tax, state tax, union territory tax, integrated tax and compensation cess in such cases.

Note: The Government vide Notification No. 16/2017 – Central Tax dated 07.07.2017 has specified following conditions for a registered person to be eligible for submission of Letter of Undertaking in place of a bond.

- (a) a status holder as specified in paragraph 5 of the Foreign Trade Policy 2015-2020; or
- (b) who has received the due foreign inward remittances amounting to a minimum of 10% of the export turnover, which should not be less than one crore rupees, in the preceding financial year.

Further, the registered person has not been prosecuted for any offence under the Central Goods and Services Tax Act, 2017 (12 of 2017) or under any of the erstwhile laws in case where the amount of tax evaded exceeds two hundred and fifty lakh rupees.

However, the above requirement **has been relaxed with effect from 04th October, 2017**

The Government vide Notification No. 37/2017 – Central Tax dated 04.10.2017 has extended the facility of Letter of Undertaking to all registered tax payers.

However, the following persons shall not be eligible to furnish LUT:

- 1) A registered person prosecuted for any offence under GST or any existing laws in force with tax evaded exceeding Rs.2.5 crores
- 2) Registered person who fails to pay tax due along with interest within:

- ✓ 15 days after the expiry of 3 months from the date of issue of the invoice for export, if the goods are not exported out of India; or
- ✓ 15 days after the expiry of 1 year, or such further period as may be allowed by the Commissioner, from the date of issue of invoice for export, if the payment of such services is not received by the exporter in convertible foreign exchange.

However, the disqualification in respect of point 2 above will cease on payment of tax along with interest.

A self-declaration by the exporter that he has not been prosecuted is sufficient for the purposes of Notification No. 37/2017- Central Tax dated 4th October, 2017. Department may verify the claim after acceptance of the LUT, unless Department has any specific information otherwise, regarding the prosecution. (Circular No. 8/8/2017-GST dated 04.10.2017)

Bond

A registered person who is not eligible to furnish an LUT for reasons discussed above, shall execute a Bond. The Bond shall be accompanied by Bank Guarantee for 15% of the Bond amount. Bond shall be furnished on non-judicial stamp paper of the value as applicable in the state in which the bond is being furnished. The exporters shall furnish a running bond where the bond amount would cover the amount of self-assessed estimated tax liability on the export. The exporter shall ensure that the outstanding integrated tax liability on exports is within the bond amount. In case the bond amount is insufficient to cover the said liability in yet to be completed exports, the exporter shall furnish a fresh bond to cover such liability. The onus of maintaining the debit / credit entries of integrated tax in the running bond will lie with the exporter. The record of such entries shall be furnished to the Central tax officer as and when required.

(Circular No. 8/8/2017-GST dated 04.10.2017).

The LUT facility is also extended to Supplies made to SEZ.

LUT to be submitted on portal

Further, the registered person (exporters) shall fill and submit FORM GST RFD-11 on the common portal. An LUT shall be deemed to be accepted as soon as an acknowledgement for the same, bearing the Application Reference Number (ARN), is generated online. If it is discovered that an exporter whose LUT has been so accepted, was ineligible to furnish an LUT in place of bond as per Notification No. 37/2017-Central Tax, then the exporter's LUT will be liable for rejection. In case of rejection, the LUT shall be deemed to have been rejected ab initio. No document needs to be physically submitted to the jurisdictional office for acceptance of LUT. (Circular No. 40/14/2018-GST dated 06.04.2018)

Jurisdictional officer for acceptance of LUT

LUT/Bond shall be accepted by the jurisdictional Deputy/Assistant Commissioner having jurisdiction over the principal place of business of the exporter. The exporter is at liberty to furnish the LUT/bond before either the Central Tax Authority or the State Tax Authority till the

administrative mechanism for assigning of taxpayers to the respective authority is implemented.

LUT for supplies to Nepal and Bhutan

Acceptance of LUT for supplies of goods to Nepal or Bhutan or SEZ developer or SEZ unit will be permissible irrespective of whether the payments are made in Indian currency or convertible foreign exchange as long as they are in accordance with the applicable RBI guidelines. It may also be noted that the supply of services to SEZ developer or SEZ unit under LUT will also be permissible on the same lines. The supply of services, however, to Nepal or Bhutan will be deemed to be export of services only if the payment for such services is received by the supplier in convertible foreign exchange.[Circular 8/8/2017 dated 4-10-17]. Supply of services having place of supply in Nepal or Bhutan against payment in Indian rupees is exempt under Notification 9/2017-IGST inserted vide Notification No. 42/2017-Integrated Tax (Rate), dated 27-10-2017.

54.9 Refund in case of Deemed Exports

Deemed Exports are defined as “Supplies” as may be notified under Section 147 of the CGST Act.

The Central Government vide Notification No. 48/2017 – Central Tax dated 18.10.2017 has notified the following items as “Deemed Exports”

- Supply of goods by a registered person against Advance Authorisation
- Supply of capital goods by a registered person against Export Promotion Capital Goods Authorisation (EPCG)
- Supply of goods by a registered person to an Export Oriented Unit (EOU) and includes:
 - ✓ Electronic Hardware Technology Park Unit (EHTP) or
 - ✓ Software Technology Park Unit (STP) or
 - ✓ Bio-Technology Park Unit (BTP).
- Supply of gold by a bank or Public Sector Undertaking specified in the Notification No. 50/2017-Customs, dated the 30.06.2017 (as amended) against Advance Authorisation.

Analysis

The Foreign Trade Policy (2015-2020) in terms of Para 7.02 has provided a list of Supplies which are Deemed Exports under FTP.

However, only the aforesaid four supplies have been covered under Deemed Export under GST. Therefore, other Deemed Export under FTP but not specified in Notification No. 48/2017 – Central Tax dated 18.10.2017 shall not be classified as Deemed Exports. The recipient of deemed exports will be eligible to take Input Tax Credit of the tax paid by the supplier subject to restrictions / blocking of credits as Section 16, 17 of the CGST Act and rules thereunder.

It is to be noted that only supply of goods and not supply of services can be classified as Deemed Exports.

Person claiming refund

The Application of refund may be filed by the Recipient of the Goods.

However, the Supplier may also file the refund application if

- a) The recipient does not avail the ITC and
- b) The supplier furnishes a declaration from the recipient that he has not availed Input Tax Credit on such deemed exports.

Special Procedures with Respect to Supply of Goods to EOUs

The Government vide Circular No. 14/14 /2017 – GST dated 06.11.2017 has issued detailed guidelines on the procedure to be adopted for Supply of goods to EOU, EHTP, STP and BTP (hereinafter collectively referred to as “EOU”)

Procedure to be adopted by the EOU:

Steps	Particulars	Form No, if any / Due Date	Explanation
Step 1	Issuance of Prior Intimation	Form-A	The EOU shall give prior intimation of goods to be procured from the Supplier in Form-A. The Intimation must be serially number and must prepared in Triplicate and sent to: (1) the Registered Supplier undertaking the Supply (2) the jurisdictional GST Officer in charge of the Supplier (3) the jurisdictional GST Officer in charge of the EOU
Step 2	Supply of goods by the Supplier		The registered supplier thereafter will supply goods under tax invoice to the recipient EOU / EHTP / STP / BTP unit.
Step 3	Endorsement of Invoice by EOU on receipt of goods		On receipt of such supplies, the EOU, shall endorse the tax invoice and send a copy of the endorsed tax invoice to – (1) the Registered Supplier undertaking the Supply

			<p>(2) the jurisdictional GST Officer in charge of the Supplier.</p> <p>(3) the jurisdictional GST Officer in charge of the EOU.</p> <p>Such endorsement is the Proof of Deemed Export Supplies by a registered person to the EOU</p>
Step 4	EOU shall maintain records for receipt, use and removal of Goods	Form-B	<p>EOU shall maintain the record of Receipt, use and Removal of Goods in Form-B</p> <p>The data is required to be maintained in Digital form.</p> <p>The Record must be updated immediately and accurately and open for Verification by the Proper office</p>
Step 5	Monthly submission of Form-B to the GST Officer	Due date - 10th of the Following month	A digital copy of Form – B containing transactions for the month, shall be provided to the jurisdictional GST officer, each month in a CD or Pen drive, as convenient to the said unit.

Documentary Evidence to be furnished by supplier for claiming refund on account of deemed exports:

A statement containing the number and date of invoices along with the following documents notified under **Notification No. 49/2017 – Central Tax dated 18th October, 2017**:

a) Proof of receipt of Goods by the Eligible Recipient viz:	
Supply to	Document required
Advance Authorisation Holder or EPCG Holder	Acknowledgment that Holder has received the goods should be obtained from the jurisdictional Tax officer having jurisdiction over the said Holder,
EOUs	Copy of the tax invoice under which such supplies have been made by the supplier, duly signed by the recipient Export Oriented Unit that said deemed export supplies have been received by it
b) Undertaking from the recipient of the Deemed Export that the Recipient has not taken Input Tax Credit of the GST paid by the Supplier	

- c) Undertaking from the recipient of the Deemed Export that they shall not claim the refund of the GST paid by the Supplier.

54.10 Rule 90 - Acknowledgement and Deficiency memo

- (a) **Acknowledgment where application relates to a claim for refund from the electronic cash ledger-** on receipt of the application for refund, an acknowledgement in FORM GST RFD-02 shall be made available to the applicant through the common portal electronically, clearly indicating the date of filing of the claim for refund and the time period of 60 days for passing an order by proper officer shall be counted from such date of filing.
- (b) **Acknowledgment where the application for refund, other than claim for refund from electronic cash ledger-** such applications shall be forwarded to the proper officer who shall, within a period of fifteen days of filing of the said application scrutinize the application for its completeness and where the application is found to be complete, an acknowledgement in FORM GST RFD-02 shall be made available to the applicant through the common portal electronically/manually, clearly indicating the date of filing of the claim for refund and the time period 60 days for passing an order by proper officer shall be counted from such date of filing.
- (c) **Deficiency Memo:** Where any deficiencies are noticed, the proper officer shall communicate the deficiencies to the applicant in FORM GST RFD-03 through the common portal electronically/manually, requiring him to file a fresh refund application after rectification of such deficiencies, with 15 days from the date of receipt of application. Hence The older application shall lapse once the deficiency notice is given in RFD-03.
- (d) If deficiencies have been communicated in FORM GST RFD-03 under the State Goods and Service Tax Rules, 2017, the same shall also deemed to have been communicated under CGST Act also.

Note: A clarification has been sought whether with respect to a refund claim, deficiency memo can be issued more than once. In this regard rule 90 of the CGST Rules may be referred to, wherein it has been clearly stated that once an applicant has been communicated the deficiencies in respect of a particular application, the applicant shall furnish a fresh refund application after rectification of such deficiencies. It is therefore, clarified that there can be only one deficiency memo for one refund application and once such a memo has been issued, the applicant is required to file a fresh refund application, manually in **FORM GST RFD-01A**. This fresh application would be accompanied with the original ARN, debit entry number generated originally and a hard copy of the refund application filed online earlier. It is further clarified that once an application has been submitted afresh, pursuant to a deficiency memo, the proper officer will not serve another deficiency memo with respect to the application for the same period, unless the deficiencies pointed out in the original memo remain unrectified,

either wholly or partly, or any other substantive deficiency is noticed subsequently. [Para 6.1 of Circular 37/11/2018 dated 15-03-2018]

Circular No. 59/2018 dated 4-10-2018 regarding actions to be taken regarding deficiency memo:

- a) Deficiency to be communicated in RFD-03
- b) Amount claimed to be re credited in RFD-01B
- c) Fresh Refund application to be filed
- d) No Show cause notice to be issued

A refund application which is re-submitted after the issuance of a deficiency memo shall have to be treated as a fresh application. No order in FORM GST RFD-04/06 can be issued in respect of an application against which a deficiency memo has been issued and which has not been resubmitted subsequently.

54.11 Rule 92 provides for Order sanctioning refund-

Rule No	Scenarios	Procedures
92(1)	When entire refund is payable	➤ Where, upon examination of the application, the proper officer is satisfied that a refund under sub-section (5) of section 54 is due and payable to the applicant, he shall make an order in FORM GST RFD-06 sanctioning the amount of refund to which the applicant is entitled, mentioning therein the amount, if any, refunded to him on a provisional basis under sub-section (6) of section 54
Proviso to 92(1)	In cases where the amount of refund is completely adjusted against any outstanding demand under the Act or under any erstwhile law	➤ the proper officer shall pass an order giving details of the adjustment, which shall be issued in Part A of FORM GST RFD-07.
92(2)	Where the proper officer or the Commissioner is of the opinion that the amount of refund is liable to be withheld under ➤ the provisions of sub-section (10) [when the applicant is required to pay tax, interest or penalty	➤ the proper officer shall pass an order in Part B of FORM GST RFD-07 informing him the reasons for withholding of such refund

	<p>which has not been stayed by any court] or,</p> <ul style="list-style-type: none"> ➤ sub-section (11) of section 54 [when any matter of appeal is pending and refund shall affect the revenue 	
92(3)	<p>Where the proper officer is satisfied that the whole or any part of the amount claimed as refund is not admissible or is not payable to the applicant</p>	<ul style="list-style-type: none"> ➤ the proper officer shall issue a notice in FORM GST RFD-08 to the applicant; ➤ the Applicant shall furnish a reply in FORM GST RFD-09 within a period of fifteen days of the receipt of such notice and ➤ after considering the reply, the proper officer shall make an order in FORM GST RFD-06 sanctioning the amount of refund in whole or part, or rejecting the said refund claim and the said order shall be made available to the applicant electronically ➤ Provided that no application for refund shall be rejected without giving the applicant an opportunity of being heard.
92(4)	<p>Refund credited to the account of applicant</p>	<ul style="list-style-type: none"> ➤ Where the proper officer is satisfied that the amount is payable to the applicant, he shall make an order in FORM GST RFD-06 then he shall issue a payment advice in FORM GST RFD-05 for refund and the same shall be electronically credited to any of the bank accounts of the applicant mentioned in his registration and as specified in the application for refund.
92(5)	<p>Refund credited to Consumer Welfare Fund</p>	<ul style="list-style-type: none"> ➤ Where the proper officer is satisfied that the amount refundable is not payable to the applicant under sub-section (8) of section 54, he shall make an order in FORM GST RFD-06 and issue an advice in FORM GST RFD-05, for the amount of refund to be credited to the Consumer Welfare Fund

Note: As per notification 39/2017-Central Tax and further modified by notification 10/2018-Central Tax dated 23-01-2018, state tax officers have been authorized to act as proper officer for the purpose of section 54 and 55 for the sanction of refund. Regarding refund of IGST paid on exports, State officer have been authorized to deal refund of IGST on export of service but can't deal IGST refund on export of goods. All other types of refunds can be dealt by state tax officer for the purpose of S. 54 & 55 of CGST.

Disbursal of Refund Amount

Circular 59/2018 dated 4-9-18 A few cases have come to notice where a tax authority, after receiving a sanction order from the counterpart tax authority (Centre or State), has refused to disburse the relevant sanctioned amount calling into question the validity of the sanction order on certain grounds. E.g. a tax officer of one administration has sanctioned, on a provisional basis, 90 per cent. Of the amount claimed in a refund application for unutilized ITC on account of exports. On receipt of the provisional sanction order, the tax officer of the counterpart administration has observed that the provisional refund of input tax credit has been incorrectly sanctioned for ineligible input tax credit and has therefore, refused to disburse the tax amount pertaining to the same. It is clarified that the remedy for correction of an incorrect or erroneous sanction order lies in filing an appeal against such order and not in withholding of the disbursement of the sanctioned amount. If any discrepancy is noticed by the disbursing authority, the same should be brought to the notice of the counterpart refund sanctioning authority, the concerned counterpart reviewing authority and the nodal officer, but the disbursal of the refund should not be withheld. It is hereby clarified that neither the State nor the Central tax authorities shall refuse to disburse the amount sanctioned by the counterpart tax authority on any grounds whatsoever, except under sub-section (11) of section 54 of the CGST Act. It is further clarified that any adjustment of the amount sanctioned as refund against any outstanding demand against the claimant can be carried out by the refund disbursing authority if not already done by the refund sanctioning authority.

Note: Refer Notification No. 55/2017–Central Tax dated 15.11.2017, mentioned above.

54.12 Rule 93 provides for the Credit of the amount of rejected refund claim

Where any amount claimed as refund is rejected under rule 92, the amount debited to the extent of rejection, shall be re-credited to the electronic credit ledger by an order made in FORM GST PMT-03. A refund shall be deemed to be rejected, if the appeal is finally rejected or if the claimant gives an undertaking in writing to the proper officer that he shall not file an appeal. Also, where any deficiencies have been communicated in FORM GST RFD-03, the amount debited under sub-rule (3) of rule 89 shall be re-credited to the electronic credit ledger.

Note: Re credit of Electronic Credit Ledger in case of Rejection of Refund claim [Circular No. 59/2018 dated 4-09-2018]

- a) Order for rejection to be passed in RFD-01B for the purpose of re credit.
- b) Before re credit an undertaking from the claimant to the effect that he shall not file an appeal against the said rejection, be obtained. If claimant files appeal, re credit to be done only after the appeal is finally decided against the claimant.

- c) For ineligible credits the amount can be paid voluntarily with interest with DRC-03. Acknowledgement in DRC-04 to be issued by proper officer. In case of fraud, wilful-misstatement or suppression of facts, penalty @ 15% also to be paid. (The amount should be paid before re credit in RFD-01B)
- d) For ineligible credits demand notice to be simultaneously issued u/s 73/74 along with RFD-01B
- e) For ineligible credits, Claimant can pay the amount voluntarily u/s 73(5)/74(5) along with interest in DRC-03 within 30 days from show cause notice. In case of 74(5), if amount and interest along with penalty @ 25% is paid within 30 days from issue of SCN, the proceedings shall be dropped.
- f) Show cause notices are not required to be issued (and consequently no orders are required to be issued in **FORM GST RFD-04/06**) in cases where refund application is not re-submitted after the issuance of a deficiency memo (in **FORM GST RFD-03**).

Demand Confirmed u/s 73(9)/74(9) to be posted to Electronic liability ledger through DRC-07

As per Circular 70/44/2018 dated 26-10-18, presently the common portal does not allow a taxpayer to file a fresh application for refund once a deficiency memo has been issued against an earlier refund application for the same period. Therefore, it is clarified that till the time such facility is developed, taxpayers would be required to submit the rectified refund application under the earlier Application Reference Number (ARN) only. Thus, it is reiterated that when a deficiency memo in **FORM GST RFD-03** is issued to taxpayers, re-credit in the electronic credit ledger (using **FORM GST RFD-01B**) is not required to be carried out and the rectified refund application would be accepted by the jurisdictional tax authorities with the earlier ARN itself.

54.13 Registers, Steps and Procedure for refund to be followed for manual processing of refunds

[Circular 17/17/2017 dated 15-11-2017]

Refunds Registers

Refunds Received Register

Table 1

Sl. No	Applicant's name	GSTIN	Date of receipt of application	Period to which the claim pertains	Nature of refund – Refund of integrated tax paid/Refund of unutilized ITC	Amount of refund claimed	Date of issue of acknowledgment in FORM GST RFD-02	Date of receipt of complete application (as mentioned in FORM GST RFD-02)
1	2	3	4	5	6	7	8	9

Refunds Register for provisional Sanction**Table 2**

Date of issue of Deficiency Memo in FORM GST RFD-03	Date of receipt of reply from the applicant	Date of issue of provisional refund order in FORM GST-RFD-04	Amount of refund claimed	Amount of provisional refund sanctioned				Date of issue of Payment Advice in FORM GST RFD-05
				CT	ST/UTI	II	Cess	
1	2	3	4	5	6	7	8	9

Refunds Register for Final Sanction of refunds**Table 3**

Date of issue of notice, if any for rejection of refund in FORM	Date of receipt of reply, if any to SCN in FORM	Date of issue of Refund sanction/rejection order in FORM GST RFD-06	Total amount of refund sanctioned				Date of issue of Payment Advice in FORM GST RFD-05	Amount of refund rejected				Date of issue of order for adjustment of sanctioned refund/withholding
			C	ST/UT	I	Ces		C	ST/UT	II	Ces	
1	2	3	4	5	6	7	8	9	10	11	12	13

Steps to be followed for refund claim [Para 3.2 of Circular 17/2017 dated 15-11-17]

1. Entry to be made in the Refund register for receipt of refund applications
2. Check for completeness of application as well as availability of the supporting documents in totality
3. All communications (issuance of deficiency memo, issuance of provisional and final refund orders, payment advice etc.) shall be done in the format prescribed in the Forms appended to the CGST Rules, and shall be done manually (i.e. not on the common portal) within the timelines prescribed in the rules;

4. Processing for grant of provisional refund shall be completed within 7 days as per the CGST Rules and details to be maintained in the register for provisional refunds. Bifurcation of the taxes to be refunded under CGST (CT) /SGST (ST) /UTGST (UT) /IGST (IT) /Cess shall be maintained in the register mandatorily
5. After the sanction of the provisional refund, final order is to be issued within sixty days (after due verification of the documentary evidences) of the date of receipt of the complete application form. The details of the finally sanctioned refund and rejected portion of the refund along with the breakup (CT / ST / UT / IT/ Cess) to be maintained in the final refund register;
6. The amount not sanctioned and eligible for re-credit is to be re-credited to the electronic credit ledger by an order made in **FORM GST PMT-03**. The actual credit of this amount will be done by the proper officer in **FORM GST RFD-01B**.

Detailed procedure for manual processing of refund claims

1. Filing of refund application in **FORM GST RFD- 01A** online on the common portal (only when refund of unutilized ITC is claimed)
2. Filing of printout of **FORM GST RFD-01A**
3. Initial scrutiny of the Documents by the proper officer
4. Issue acknowledgement manually within 15 days in **FORM GST RFD-02**
5. Grant of provisional refund within seven days of issue of acknowledgement
6. Detailed scrutiny of the refund application along with submitted documents
7. Steps to be taken If the sanction-able amount is less than the applied amount
8. Pre-Audit
9. Final sanction of refund
10. Payment of interest if any

54.14 Comparative review

These provisions are broadly similar to the provisions contained in erstwhile Central Indirect Tax law. However, they are restrictive when compared to the refund mechanism under earlier State Value Added Tax law. The GST Law provides refund of unutilised credit in certain specified circumstances where the State VAT Laws provide for refund of unutilised credit under any circumstances.

54.15 Issues and Concerns

- I. Can a registered person exporting non-taxable goods (say, motor spirit) claim refund of inputs and input services utilised in the manufacture of such non-taxable goods?

Although this is a debatable issue, some experts believe that the law does not place restriction on claiming refund of taxes paid on inward supplies used in effecting such export of non-taxable goods. This could be argued on the following grounds:

- Zero rated supply includes within its ambit, inter alia, export of goods
- Motor spirit, although non-taxable, would fall within the meaning of goods as defined in Section 2(52) of the CGST Act
- Section 17(2) of the CGST Act states that a supplier shall be entitled to avail input tax credit to the extent of input tax as is attributable to taxable supplies including zero rated supplies.
- Section 16(2) of the IGST Act states that input tax credit may be availed for making zero rated supplies notwithstanding the fact that such supply may be an exempt supply subject to restrictions on ITC in Section 17(5).
- Exempt supply has been defined in Section 2(47) of the CGST Act to include non-taxable supply.
- Section 54(3) of the CGST Act specifies that refund of unutilised input tax credit shall be allowed in case of zero rated supplies effected without payment of tax unless such export are subjected to export duty. Thus, refund on export of non-taxable goods may be sought by the registered person.

This position is clarified by CBIC wherein it is stated that as per section 16(2) of the IGST Act, credit of input tax may be availed for making zero rated supplies, notwithstanding that such supply is an exempt supply. It is also categorically stated that the requirement of Bond/LUT cannot be insisted upon in such cases. (Circular No 45/2018 dated 30.05.2018)

Can a registered person being an exporter claim refund of unutilised input tax credit being transitional credit carried forward from the pre-GST regime?

Under the GST law, there is no provision specifically providing for refund of transitional credit. Section 54(3) pertains to refund of unutilised input tax credit.

Section 2(63) of the CGST Act defines "input tax credit" to broadly refer to CGST, SGST, UTGST and IGST charged on the supply of goods or services. Thus, it is apparent from the definition that taxes paid under pre-GST regime does not fulfil this criteria to be classified as input tax credit as referred to in Section 54(3).

However, Explanation (1) to Section 54(14) of the CGST Act defines "refund" to include, inter alia, refund of tax paid on zero rated supplies. Thus, it is advisable that the exporter opts to export goods or services on payment of tax, utilise such transitional credit for payment of output tax on exports and then apply for refund of the tax paid on exports.

- II. Refund in respect of tax paid on capital goods used by an registered person for effecting exports.

It is interesting to note that Explanation (1) to Section 54(14) of the CGST Act defines “refund” to include, inter alia, inputs and input services used in making zero rated supplies. On the same lines, “NET ITC” as defined under Rule 89(4) of the CGST Rules, refers to merely input tax credit availed on inputs and input services. Thus conspicuous by its absence is the fact that refund of unutilised input tax credit on account of zero rated supplies is not available in respect of capital goods.

Such a scenario may be countered by the exporter by choosing to export on payment of tax. As was the case in (II) above, the exporter who opts to export goods or services on payment of tax can utilise input tax credit accumulated on capital goods towards payment of output tax on exports and subsequently apply for refund of taxes paid on exports.

From the above scenarios, it is interesting to note that a registered person should wisely exercise his option to either effect zero-rated supplies on payment of tax or without payment of tax based on the facts of the case and there can be no general rule that can be applied to one and all.

- III. Determination of Authorised Operations in respect of supplies made to a SEZ developer or SEZ unit.

The Second proviso to Rule 89 of the CGST Rules, states that in respect of supplies to a Special Economic Zone unit or a Special Economic Zone developer, the supplier of goods or services can apply for refund if such supplies are being used for authorised operations. The question which arises is, who determines the authorised operations and who is the specified officer referred to in the said Rule.

‘Authorised Operations’ has been defined under Section 2(c) of the SEZ Act to mean:

- For a SEZ Developer – The Board of Approval may authorise the Developer such operations which the Central Government may authorise
- For a SEZ Unit – Operations as authorised by the Development Commissioner in the Letter of Approval.

‘Specified officer’ has been defined in the SEZ Rules to mean a Joint or Deputy or Assistant Commissioner of Customs for the time being posted in the SEZ.

Thus, the terms as defined above, may be adopted for the purpose of Rule 89 of the GST Rules.

54.16 FAQs

Q1. Is there a time limit to file refund claim?

Ans. Generally, Yes. The refund claim has to be filed within two years from the relevant date.

However, if the tax or interest thereon or amount claimed as refund is paid under protest, the time limit is not applicable.

Q2. Whether there is any provision for condonation of delay in filing refund claim beyond two years from the relevant date (where tax/interest/amount is not paid under protest)?

Ans. No. There is no provision to condone the delay and the refund claim will be rejected without getting into merits of the refund claim.

Q3. Whether there is any procedure to pay tax/interest/amount under protest?

Ans. There is no mechanism or procedure set out in the GST Act or. As per the practice prevailing under the erstwhile central indirect tax laws, a letter expressing the fact that the tax/interest/amount is being paid under protest setting out the reason may be sufficient to consider that the payment is made under protest.

Q4. What would be the time limit for sanctioning refund?

Ans. The refund has to be sanctioned within 60 days from the receipt of duly completed application containing all the prescribed information/documents.

Q5. What happens in case the incidence of duty/tax has been passed on by the person claiming the refund?

Ans. The refund claimed and eligible will be credited to Consumer Welfare Fund.

Q6. Is there a minimum amount specified below which no refund can be claimed?

Ans. Yes. The minimum amount of refund payable should be ` 1000/- or more.

Q7. Whether refund of unutilized credit at the end of tax period can be claimed by supplier who does not have any exports.

Ans. Yes. It is available in cases where the accumulation of credit is for the reason of tax rate on inputs and input services being higher than the rate of tax on outputs other than NIL rated or fully exempted outward supply.

54.17 MCQs

Q1. In case of refund claim on account of export of goods and/or services made by such category of registered taxable persons as may be notified in this behalf, what percent would be granted as refund on a provisional basis?

- (a) 70%
- (b) 65%
- (c) 80%
- (d) 90%

Ans. (d) 90%

Q2. What is the relevant date in case of refund on account of excess payment of GST due to mistake or inadvertence?

- (a) Date of payment of GST
- (b) Last day of the financial year
- (c) Date of providing of service
- (d) None of the above

Ans. (a) Date of payment of GST

Q3. Refund of accumulated input tax of inputs credit at the end of any tax period is eligible in cases of?

- (a) Due to purchase of huge stocks
- (b) Credit cannot be used for any reason.
- (c) Due to Exports and input tax rate of inputs being higher than output tax rate
- (d) Due to Exports only.

Ans. (c) Due to Exports and input tax rate of inputs being higher than output tax rate

Q4. Relevant date for computing time limit to claim refund in case of deemed exports supply of goods is –

- (a) Date of filing returns relating to such deemed exports;
- (b) Date of goods leaving India;
- (c) Date of payment of Tax;
- (d) Date of receipt of consideration in Foreign Exchange;

Ans. (a) Date of filing returns relating to such deemed exports

Statutory Provisions

55. Refund in certain cases

The Government may, on the recommendation of the Council, by notification, specify any specialized agency of the United Nations Organization or any Multilateral Financial Institution and Organization notified under the United Nations (Privileges and Immunities) Act, 1947, Consulate or Embassy of foreign countries and any other person or class of persons as may be specified in this behalf, who shall, subject to such conditions and restrictions as may be prescribed, be entitled to claim a refund of taxes paid on the notified supplies of goods or services or both received by them.

Extract of the CGST Rules, 2017

95 Refund of tax to certain persons

- 1) Any person eligible to claim refund of tax paid by him on his inward supplies as per notification issued section 55 shall apply for refund in FORM GST RFD-10 once in every quarter, electronically on the common portal or otherwise, either directly or

through a Facilitation Centre notified by the Commissioner, along with a statement of the inward supplies of goods or services or both in FORM GSTR-11.

- 2) *An acknowledgement for the receipt of the application for refund shall be issued in FORM GST RFD-02.*
- 3) *The refund of tax paid by the applicant shall be available if-*
 - a) *the inward supplies of goods or services or both were received from a registered person against a tax invoice*
 - b) *name and Goods and Services Tax Identification Number or Unique Identity Number of the applicant is mentioned in the tax invoice; and*
 - c) *such other restrictions or conditions as may be specified in the notification are satisfied.*
- 4) *The provisions of rule 92 shall, mutatis mutandis, apply for the sanction and payment of refund under this rule.*
- 5) *Where an express provision in a treaty or other international agreement, to which the President or the Government of India is a party, is inconsistent with the provisions of this Chapter, such treaty or international agreement shall prevail.*

Relevant circulars, notifications, clarifications issued by Government:

- 1) Notification No. 6/2017-Central Tax (Rate) dated 28-06-2017 issued by CBIC for refund of 50% of CGST on supplies of goods to Canteen Stores Department
- 2) Notification No. 16/2017-Central Tax (Rate) dated 28-06-2017 issued by CBIC notifying specialized agencies entitled to claim refund
- 3) Notification 26/2018-Central Tax dated 13.06.2018 issued by CBIC substituting clause (a) in sub rule (3) in Rule 95.
- 4) Circular No. 36/2018 dated 13.03.2018 issued by CBIC regarding Processing of refund applications for UIN entities
- 5) Circular No. 43/2018 dated 13.04.2018 issued by CBIC addressing queries relating to processing of refund applications for UIN entities
- 6) Circular No. 60/34/2018-GST dated 04-09-2018 issued by CBIC regarding processing of refund applications of CSD
- 7) Circular No. 63/37/2018-GST dated 14-09-2018 issued by CBIC providing clarification regarding processing of refund claims filed by UIN Entities
- 8) Chapter Thirty Four of the compilation of the GST Flyers as issued by the CBIC on 'Refunds under GST'
- 9) Press Release on Acceptance of Unique Identity Number of Foreign Diplomatic Missions / UNO while making sales or supplies dated 13-11-2017
- 10) Press Release on Advisory to UIN Entities claiming GST Refunds dated 9-11-2018

Related Provisions of the Statute

Section or Rule	Description
Section 54	Refund of Tax
Rule 92	Order sanctioning refund

55.1 Introduction

This section deals with refund of taxes paid on notified supplies of goods or services or both received by certain specified agencies notified by the Government on the recommendation of the Council.

55.2 Analysis

This section provides that –

- (i) The Government, is vested with powers to notify certain agencies on the recommendation of the Council, to be entitled to claim refund.
- (ii) The agencies that can be notified are –
 - (a) any specialized agency of the United Nations Organization or
 - (b) any Multilateral Financial Institution and Organization notified under the United Nations (Privileges and Immunities) Act, 1947,
 - (c) any other person or class of persons as may be specified.
- (iii) In addition to the above, Consulate or Embassy of foreign countries would also be eligible for refund.
- (iv) The agencies mentioned above would be entitled to claim a refund of taxes paid on the notified supplies of goods or services or both received by them. The refund claim is subject to such conditions and restrictions as may be prescribed,

55.3 Procedure for refund of tax

The Government vide Circular No. 36/10/2018-GST dated 13.03.2018, Circular No. 43/17/2018-GST dated 13.04.2018, Circular 60/34/2018 dated 04-09-2018 and 63/37/2018-GST dated 14-09-2018 has clarified some of the issues to ensure uniformity which are as under:

- (a) The FORM GSTR-11 along with FORM GST RFD-10 has to be filed separately for each of those quarters for which refund claim is being filed.
- (b) All the entities claiming refund shall submit the duly filled in print out of FORM RFD-10 to the jurisdictional Central Tax Commissionerate. All refund claims shall be processed and sanctioned by respective Central Tax offices. In order to facilitate processing of refund claims of UIN entities, a nodal officer has been designated in each State. Application for refund claim may be submitted before the designated Central Tax nodal officers in the State in which the UIN has been obtained.

- (c) The print version of FORM GSTR-11 generated by the system does not have invoice-wise details. Therefore, it is clarified that till the system generated FORM GSTR-11 does not have invoice-level details, UIN agencies are requested to manually furnish a statement containing the details of all the invoices on which refund has been claimed, along with refund application.
- (d) The recording of UIN on the invoice is a necessary condition under rule 46 of the CGST Rules, 2017. If suppliers / vendors are not recording the UINs, action may be initiated against them under the provisions of the CGST Act, 2017.
- (e) Refunds can be claimed by UIN entities only those inward supplies which are in accordance with reciprocity letter issued by MEA.
- (f) UIN entities should submit hard copies of invoices where UIN is not mentioned. One-time waiver is hereby given from recording the UIN on the invoices issued by the suppliers pertaining to the refund claims filed for the quarters from April, 2018 to March, 2019, subject to the condition that the copies of such invoices which are attested by the authorized representative of the UIN entity shall be submitted to the jurisdictional officer
- (g) UIN entities must submit the copy of the 'Prior Permission letter' and mention the same in the covering letter while applying for GST refund on purchase of vehicles.
- (h) The eligibility of refund for the personnel and officials posted in the Embassy/Mission/Consulate shall be determined based on the principle of reciprocity.
- g) UIN entities should give declaration as per Notifications No. 13/2017 – Integrated Tax (Rate), 16/2017-Central Tax (Rate) and No. 16/2017 – Union Territory tax (Rate) all dated 28th June, 2017 and corresponding notifications under the respective State Goods and Services Tax Acts .
- h) The CSD are required to apply for refund on a quarterly basis. Till the time the online utility for filing the refund claim is made available on the common portal, the CSD shall apply for refund by filing an application in FORM GST RFD-10A (Annexure-A to this Circular) manually to the jurisdictional tax office. The said form shall be accompanied with the following documents:
 - (i) An undertaking stating that the goods on which refund is being claimed have been received by the CSD;
 - (ii) A declaration stating that no refund has been claimed earlier against the invoices on which the refund is being claimed;
 - (iii) Copies of the valid return filed in FORM GSTR-3B by the CSD for the period covered in the refund claim;

(iv) Copies of FORM GSTR-2A of the CSD for the period covered in the refund claim along with the attested hard copies of the invoices on which refund is claimed but which are not reflected in FORM GSTR-2A;

(v) Details of the bank account in which the refund amount is to be credited.

The procedure for issue of acknowledgment in RFD-02 and deficiency memo in RFD-03 is same as in case of other refunds.

The amount of sanctioned refund in respect of central tax/integrated tax along with the bank account details of the CSD shall be manually submitted in the PFMS system by the jurisdictional Division's DDO and a signed copy of the sanction order shall be sent to the PAO for release of the said amount.

Checklist for processing UIN refunds

- (a) Covering letter for each quarterly refund
- (b) Final copy of **FORM GST RFD- 10** with Application Reference Number (ARN)
- (c) Final copy of **FORM GSTR – 11**
- (d) Statement of invoices as per Annexure D
- (e) Certificate in case of goods that the goods have been used according to Notifications No. 13/2017 – Integrated Tax (Rate), 16/2017-Central Tax (Rate) and No. 16/2017 – Union Territory tax (Rate) all dated 28th June, 2017 and corresponding notifications under the respective State Goods and Services Tax Acts
- (f) Undertaking in case of services that the services have been used according to Notifications No. 13/2017 – Integrated Tax (Rate), 16/2017-Central Tax (Rate) and No. 16/2017 – Union Territory tax (Rate) all dated 28th June, 2017 and corresponding notifications under the respective State Goods and Services Tax Acts
- (g) Copy of letter issued by the Protocol Division of the Ministry of External Affairs based on the principle of reciprocity
- (h) Photocopies of only those invoices where UIN has not been recorded on the invoices by the supplier.
- (i) A cancelled cheque of the bank account as mentioned in **FORM GST RFD-10** (to be submitted with only the first refund claim filed)

Note: In terms of Notification No. 55/2017 – Central Tax dated 15th November 2017, Rule 97A has been inserted in the Central Goods and Service Tax Rules, 2017.

In terms of Rule 97A, refunds may be permitted to be filed manually and the processing of refund with respect to any notice, reply or order, among others, can also be issued / filed manually.

55.4 FAQs

1. Name the agencies that can be notified to be eligible to claim refund of taxes under Section 55 of the CGST Act?

Ans. Any specialized agency of the United Nations Organization or any Multilateral Financial Institution and Organization notified under the United Nations (Privileges and Immunities) Act, 1947 and any other person or class of persons as may be specified in this behalf, are the agencies that can be notified.

2. What refund are the agencies specified above entitled to claim under this section?

Ans. The agencies specified above are entitled to claim a refund of taxes paid on the notified supplies of goods or services or both received by them.

55.5 MCQs

Q1. Who is empowered to notify the agencies that are entitled to claim refund under this section?

- (a) Government on the recommendations of the GST Council
- (b) Board
- (c) GST Council
- (d) None of the above

Ans. (a) Government on the recommendations of the GST Council

Statutory Provisions**56. Interest on delayed refunds**

If any tax ordered to be refunded under sub-section (5) of section 54 to any applicant is not refunded within sixty days from the date of receipt of application under sub-section (1) of that section, interest at such rate not exceeding six per cent as may be specified in the notification issued by the Government on the recommendations of the Council shall be payable in respect of such refund from the date immediately after the expiry of sixty days from the date of receipt of an application under the said sub-section till the date of refund of such tax.

Provided that where any claim of refund arises from an order passed by an adjudicating authority or Appellate Authority or Appellate Tribunal or court which has attained finality and the same is not refunded within sixty days from the date of receipt of application filed consequent to such order, interest at such rate not exceeding nine per cent. as may be notified by the Government on the recommendations of the Council shall be payable in respect of such refund from the date immediately after the expiry of sixty days from the date of receipt of application till the date of refund.

Explanation.- For the purpose of this section, where any order of refund is made by an Appellate Authority, Tribunal or any Court against an order of the proper officer under sub-

section (5) of section 54, the order passed by the Appellate Authority, Appellate Tribunal or, by the Court shall be deemed to be an order passed under the said sub-section (5).

Extract of the CGST Rules, 2017

94 Order sanctioning interest on delayed refunds

Where any interest is due and payable to the applicant under section 56, the proper officer shall make an order along with a payment advice in FORM GST RFD-05, specifying therein the amount of refund which is delayed, the period of delay for which interest is payable and the amount of interest payable, and such amount of interest shall be electronically credited to any of the bank accounts of the applicant mentioned in his registration particulars and as specified in the application for refund.

Relevant circulars, notifications, clarifications issued by Government:

- 1) Notification No.13 /2017 – Central Tax dated 28.06.2017 notifying interest rates.
- 2) Chapter Thirty Four of the compilation of the GST Flyers as issued by the CBIC on 'Refunds under GST'

56.1. Introduction

This section provides for payment of interest on delayed refunds beyond the period of sixty days from the date of receipt of application to avoid delays in sanction or grant of refund.

56.2. Analysis

- (i) The section provides that interest is payable if –
 - Tax paid becomes refundable under section 54(5) to the applicant; and
 - It is not refunded within 60 days from the date of receipt of application for refund of tax under Section 54(1)
- (ii) Interest is liable to be paid from the due date for payment of refund till the date of sanction or grant of refund.
- (iii) For the above delay, the Government has specified 6% as the rate of interest vide Notification No.13 /2017 – Central Tax dated 28.06.2017.

Illustration:

A Ltd has filed a refund claim of excess tax paid with all the documents and records on 19.08.2017. The department sanctioned the refund on 30.11.2017. In such a case, interest has to be paid for the period from 19.10.2017 to 30.11.2017.

- (iv) Explanation to section provides that in cases where the orders of Appellate Authority / Tribunal / Court sanctions refund in an appeal, against the order of refund sanctioning authority, the order of Appellate Authority / Tribunal / Court will be considered as orders passed by refund sanctioning authority. In other words, by virtue of such order, the

refund has become due and the interest will then be computed from the date of completion of 60 days from the date of original refund claim made. For all such claims the Government has specified 9% as the rate of interest vide Notification No.13 /2017 – Central Tax dated 28.06.2017.

Illustration:

A Ltd has filed a refund claim of excess tax paid with all the documents and records on 19.08.2017. It was rejected by refund sanctioning authority. On Appeal the Appellate Authority passed the order for refund based on which the department sanctioned the refund on 30.09.2018. In such case, interest has to be paid for the period from 18.10.2017 to 30.09.2018.

(v) **Rule 94 provides for Order sanctioning interest on delayed refunds-** where any interest is due and payable to the applicant under section 56, the proper officer shall make an order along with a payment advice in FORM GST RFD-05, specifying the following:

- (a) Amount of refund which is delayed,
- (b) the period of delay for which interest is payable and
- (c) the amount of interest payable,

and such amount of interest shall be electronically credited to any of the bank accounts of the applicant.

56.3. Comparative review

The refund provisions under the GST regime are in line with the refund provisions envisaged in the erstwhile regime under Central Excise law under section 11BB of the Central Excise Act, 1944.

56.4. FAQs

Q1. Whether interest is payable on delayed sanction of refund of tax only?

Ans. Yes. The provision for payment of interest is only with respect to delayed payment of refund of tax only and not interest or any other amount sanctioned as refund.

Q2. What would be the rate of interest on delay of sanctioning refund?

Ans. The government has specified 6% as the rate of interest for delay in refund under Section 54(5) and 9% for the delay of refund arising from an order passed by an adjudicating authority vide notification no. Notification No. 13 /2017 – Central Tax dated June 28, 2017.

Q3. Whether interest is payable on delayed refund of unutilized input tax credit.

Ans. The provision only refers to refund claim under Section 48(1) relating to tax paid and not Section 54(3). Therefore, there is no provision for payment of interest on delayed refund of unutilized input tax credit.

56.5. MCQs

Q1. Interest U/s 56 is applicable on delayed payment of refunds issued under?

- (a) Section 54
- (b) Section 44
- (c) Section 41
- (d) Section 45

Ans. (b) Section 54

Q2. Interest U/s56 has to be paid for delayed refunds, if the refund is not granted within.....

- (a) 90 days
- (b) 3 months
- (c) 60 days
- (d) None of the above

Ans. (c) 60 days

Statutory Provisions**57. Consumer Welfare Fund**

The Government shall constitute a Fund, to be called the Consumer Welfare Fund and there shall be credited to the Fund, —

- (a) *the amount referred to in sub-section (5) of section 54;*
- (b) *any income from investment of the amount credited to the Fund; and*
- (c) *such other monies received by it,*
in such manner as may be prescribed.

Extract of the CGST Rules, 2017**97 Consumer Welfare Fund**

- 1) *All amounts of duty/central tax/ integrated tax /Union territory tax/cess and income from investment along with other monies specified in subsection (2) of section 12C of the Central Excise Act, 1944 (1 of 1944), section 57 of the Central Goods and Services Tax Act, 2017 (12 of 2017) read with section 20 of the Integrated Goods and Services Tax Act, 2017 (13 of 2017), section 21 of the Union Territory Goods and Services Tax Act, 2017 (14 of 2017) and section 12 of the Goods and Services Tax (Compensation to States) Act, 2017 (15 of 2017) shall be credited to the Fund:*

Provided that an amount equivalent to fifty per cent. of the amount of integrated tax determined under sub-section (5) of section 54 of the Central Goods and Services Tax Act, 2017, read with section 20 of the Integrated Goods and Services Tax Act, 2017, shall be deposited in the Fund.

Provided further that an amount equivalent to fifty per cent. of the amount of cess determined under sub-section (5) of section 54 read with section 11 of the Goods and Services Tax (Compensation to States) Act, 2017 (15 of 2017), shall be deposited in the Fund.

- 2) *Where any amount, having been credited to the Fund, is ordered or directed to be paid to any claimant by the proper officer, appellate authority or court, the same shall be paid from the Fund.*
- 3) *Accounts of the Fund maintained by the Central Government shall be subject to audit by the Comptroller and Auditor General of India.*
- 4) *The Government shall, by an order, constitute a Standing Committee (hereinafter referred to as the Committee') with a Chairman, a Vice-Chairman, a Member Secretary and such other members as it may deem fit and the Committee shall make recommendations for proper utilisation of the money credited to the Fund for welfare of the consumers.*
- 5)
 - (a) *The Committee shall meet as and when necessary, generally four times in a year;*
 - (b) *the Committee shall meet at such time and place as the Chairman, or in his absence, the Vice-Chairman of the Committee may deem fit;*
 - (c) *the meeting of the Committee shall be presided over by the Chairman, or in his absence, by the Vice-Chairman;*
 - (d) *the meeting of the Committee shall be called, after giving at least ten days' notice in writing to every member;*
 - (e) *the notice of the meeting of the Committee shall specify the place, date and hour of the meeting and shall contain statement of business to be transacted thereat;*
 - (f) *no proceeding of the Committee shall be valid, unless it is presided over by the Chairman or Vice-Chairman and attended by a minimum of three other members.*
- 6) *The Committee shall have powers -*
 - a) *to require any applicant to get registered with any authority as the Central Government may specify;*
 - b) *to require any applicant to produce before it, or before a duly authorised officer of the Central Government or the State Government, as the case may be, such books, accounts, documents, instruments, or commodities in custody and control of the applicant, as may be necessary for proper evaluation of the application;*
 - c) *to require any applicant to allow entry and inspection of any premises, from which*

- activities claimed to be for the welfare of consumers are stated to be carried on, to a duly authorised officer of the Central Government or the State Government, as the case may be;*
- d) to get the accounts of the applicants audited, for ensuring proper utilisation of the grant;*
 - e) to require any applicant, in case of any default, or suppression of material information on his part, to refund in lump-sum along with accrued interest, the sanctioned grant to the Committee, and to be subject to prosecution under the Act;*
 - f) to recover any sum due from any applicant in accordance with the provisions of the Act;*
 - g) to require any applicant, or class of applicants to submit a periodical report, indicating proper utilisation of the grant;*
 - h) to reject an application placed before it on account of factual inconsistency, or inaccuracy in material particulars*
 - i) to recommend minimum financial assistance, by way of grant to an applicant, having regard to his financial status, and importance and utility of the nature of activity under pursuit, after ensuring that the financial assistance provided shall not be misutilised;*
 - j) to identify beneficial and safe sectors, where investments out of Fund may be made, and make recommendations, accordingly;*
 - k) to relax the conditions required for the period of engagement in consumer welfare activities of an applicant;*
 - l) to make guidelines for the management, and administration of the Fund*
- 7) The Committee shall not consider an application, unless it has been inquired into, in material details and recommended for consideration accordingly, by the Member Secretary.*
- 8) The Committee shall make recommendations:-*
- a) for making available grants to any applicant;*
 - b) for investment of the money available in the Fund;*
 - c) for making available grants (on selective basis) for reimbursing legal expenses incurred by a complainant, or class of complainants in a consumer dispute, after its final adjudication;*
 - d) for making available grants for any other purpose recommended by the Central Consumer Protection Council (as may be considered appropriate by the Committee);*

- e) *for making available up to 50% of the funds credited to the Fund each year, for publicity/ consumer awareness on GST, provided the availability of funds for consumer welfare activities of the Department of Consumer Affairs is not less than twenty five crore rupees per annum.*

Explanation.- For the purposes of this rule,

- a) *'Act' means the Central Goods and Services Tax Act, 2017 (12 of 2017), or the Central Excise Act, 1944 (1 of 1944) as the case may be;*
- b) *'applicant' means,*
- (i) *the Central Government or State Government;*
 - (ii) *regulatory authorities or autonomous bodies constituted under an Act of Parliament or the Legislature of a State or Union Territory;*
 - (iii) *any agency or organization engaged in consumer welfare activities for a minimum period of three years, registered under the Companies Act, 2013 (18 of 2013) or under any other law for the time being in force;*
 - (iv) *village or mandal or samiti or samiti level co-operatives of consumers especially Women, Scheduled Castes and Scheduled Tribes;*
 - (v) *an educational or research institution incorporated by an Act of Parliament or the Legislature of a State or Union Territory in India or other educational institutions established by an Act of Parliament or declared to be deemed as a University under section 3 of the University Grants Commission Act, 1956 (3 of 1956) and which has consumers studies as part of its curriculum for a minimum period of three years; and*
 - (vi) *a complainant as defined under clause (b) of sub-section (1) of section 2 of the Consumer Protection Act, 1986 (68 of 1986), who applies for reimbursement of legal expenses incurred by him in a case instituted by him in a consumer dispute redressal agency.*
- c) *'application' means an application in the form as specified by the Standing Committee from time to time;*
- d) *'Central Consumer Protection Council' means the Central Consumer Protection Council, established under sub-section (1) of section 4 of the Consumer Protection Act, 1986 (68 of 1986), for promotion and protection of rights of consumers;*
- e) *'Committee' means the Committee constituted under sub-rule (4);*
- f) *'consumer' has the same meaning as assigned to it in clause (d) of sub-section (1) of section 2 of the Consumer Protection Act, 1986 (68 of 1986), and includes consumer of goods on which central tax has been paid;*

- g) 'duty' means the duty paid under the Central Excise Act, 1944 (1 of 1944) or the Customs Act, 1962 (52 of 1962);
- h) 'Fund' means the Consumer Welfare Fund established by the Central Government under sub-section (1) of section 12C of the Central Excise Act, 1944 (1 of 1944) and section 57 of the Central Goods and Services Tax Act, 2017 (12 of 2017);
- i) 'proper officer' means the officer having the power under the Act to make an order that the whole or any part of the central tax is refundable

Relevant circulars, notifications, clarifications issued by Government

- 1) Chapter Thirty Four of the compilation of the GST Flyers as issued by the CBIC on 'Refunds under GST'
- 2) Notification 21/2018-Central Tax dated 18.04.2018 issued by CBIC substituting Rule 97 with the existing provisions of Consumer Welfare Fund
- 3) Notification 26/2018-Central Tax dated 13.06.2018 issued by CBIC inserting the second proviso to Rule 97(1).

Related Provisions of the Statute

Section or Rule	Description
Section 54	Refund of Tax
Section 58	Utilisation of Fund

57.1 Introduction

If the applicant is unable to prove that the incidence was not actually passed onto any other person then the refund amount is credited to the Consumer Welfare Fund.

The overall objective of the Consumer Welfare Fund is to provide financial assistance to promote and protect the welfare of the consumers and strengthen the consumer movement in the country.

57.2 Analysis

The following amounts will be credited to the Fund, in such manner as may be prescribed, -

- All amounts of duty/central tax/ integrated tax /Union territory tax/cess
- income from investment along with other monies specified in section 12C(2) of the Central Excise Act, 1944.

However, in case of integrated tax and compensation cess as determined under Section 54(5), an amount equal to fifty percent of such sum shall be deposited in the fund.

In case of any amount that has been credited to the fund that is now ordered or directed to be to be paid to a claimant by the proper officer, appellate authority or court, then, the same shall be paid from the fund.

57.3 Audit of the Accounts of the Fund

Rule 97(3) provides that the accounts of the fund shall be maintained by the Central Government and subject to audit by Comptroller and Auditor General of India.

57.4 Constitution of the Committee

Rule 97 of the CGST Rules provides that The Government shall constitute a Standing Committee with a Chairman, a Vice-Chairman, a Member Secretary and such other Members as it may deem fit and the Committee shall make recommendations for proper utilisation of the money credited to the Consumer Welfare Fund for welfare of the consumers. The Committee shall meet as and when necessary, generally four times in a year.

57.5 Meeting of the Committee

Rule 97(5) provides that the committee shall be required to comply with the following with regard to its meetings:

- The committee shall meet as and when necessary, generally four times a year.
- The committee shall meet at such time and place as the Chairman, or in his absence, the Vice Chairman may deem fit.
- The meetings of the Committee shall be précised by the Chairman, or in his absence by the Vice Chairman of the Committee
- A committee meeting shall be called after giving a minimum ten days' notice in writing to every member.
- The notice of the meeting of the Committee is required to specify the place, date and hour of the meeting along with a statement of business to be transacted thereat.
- A meeting shall not be valid, unless it is presided over by the Chairman, or in his absence, the Vice Chairman and attended by a minimum of three other members.

57.6 Powers of the Committee

The Committee shall have the following powers:

- To require any applicant to get registered with any authority as the Central Government may specify;
- to require any applicant to produce before it, or before a duly authorised officer of the Central Government or the State Government, as the case may be, such books, accounts, documents, instruments, or commodities in custody and control of the applicant, as may be necessary for proper evaluation of the application;

- to require any applicant to allow entry and inspection of any premises, from which activities claimed to be for the welfare of consumers are stated to be carried on, to a duly authorised officer of the Central Government or the State Government, as the case may be;
- to get the accounts of the applicants audited, for ensuring proper utilisation of the grant;
- to require any applicant, in case of any default, or suppression of material information on his part, to refund in lump-sum along with accrued interest, the sanctioned grant to the Committee, and to be subject to prosecution under the Act;
- to recover any sum due from any applicant in accordance with the provisions of the Act;
- to require any applicant, or class of applicants to submit a periodical report, indicating proper utilisation of the grant;
- to reject an application placed before it on account of factual inconsistency, or inaccuracy in material particulars;
- to recommend minimum financial assistance, by way of grant to an applicant, having regard to his financial status, and importance and utility of the nature of activity under pursuit, after ensuring that the financial assistance provided shall not be misutilised;
- to identify beneficial and safe sectors, where investments out of Fund may be made, and make recommendations, accordingly;
- to relax the conditions required for the period of engagement in consumer welfare activities of an applicant;
- to make guidelines for the management, and administration of the Fund.

57.7 Utilisation of funds by the Committee

Rule 97 of the CGST Rules also provides that any utilisation of amount from the Consumer Welfare Fund under sub-section (1) of section 58 shall be made by debiting the Consumer Welfare Fund account and crediting the account to which the amount is transferred for utilisation.

The Rule also clearly lays down the manner in which the proceedings of the Committee are to be regulated, the powers that may be exercised and recommendations that may be made by such Committee

57.8 Comparative review

These provisions are broadly similar to the provisions contained in erstwhile Central Indirect Tax laws.

57.9 MCQs

- Q1. In cases where the application of refund is found to be in order, the refund amount shall be credited to Fund.

- (a) Investor Protection and Education Fund
- (b) Consumer Protection Fund
- (c) Consumer Welfare Fund
- (d) Refund Claim Fund

Ans. (c) Consumer Welfare Fund

Q2. The overall objective of the Consumer Welfare Fund is

- (a) To facilitate a simplified refund mechanism.
- (b) to promote and protect the welfare of the consumers and strengthen the consumer movement in the country.
- (c) To boost the overall growth of the economy
- (d) Both (a) and (c)

Ans. (b) to promote and protect the welfare of the consumers and strengthen the consumer movement in the country

Statutory Provisions

58. Utilization of the Fund

- (1) *All sums credited to the Fund shall be utilised by the Government for the welfare of the consumers in such manner as may be prescribed.*
- (2) *The Government or the authority specified by it shall maintain proper and separate account and other relevant records in relation to the Fund and prepare an annual statement of accounts in such form as may be prescribed in consultation with the Comptroller and Auditor-General of India.*

Relevant circulars, notifications, clarifications issued by Government:

- 1) Chapter Thirty Four of the compilation of the GST Flyers as issued by the CBIC on 'Refunds under GST'

Related Provisions of the Statute

Section or Rule	Description
Section 54	Refund of Tax
Section 57	Consumer Welfare Fund

58.1 Introduction

The monies credited to the Consumer Welfare Fund are meant to provide financial assistance to promote and protect the welfare of the consumers and strengthen the consumer movement in the country.

58.2 Analysis

- (i) It should be ensured that the monies credited to the fund shall be utilized to provide assistance to protect the welfare of consumers as per the rules made by the Government
- (ii) The Government shall maintain proper and separate records in relation to the Fund in consultation with the Comptroller and Auditor-General of India.

58.3 Comparative review

These provisions are broadly similar to the erstwhile provisions contained in Section 12D of the Central Excise Act, 1944.

58.4 FAQs

Q1. How can it be traced whether the amount in the fund is utilised for the welfare of the consumers?

Ans. The Government shall maintain proper and separate account and other relevant records in relation to the Fund and prepare an annual statement of accounts in such form as may be prescribed in consultation with the Comptroller and Auditor-General of India. From these records, it can be ascertained if the amount in the fund were utilised for the welfare of the consumers.

58.5 MCQs

Q1. Proper and separate account and other relevant records in relation to the Fund in prescribed form in consultation with the Comptroller and Auditor-General of India shall be maintained by

- (a) the Government
- (b) the authority specified by the Government
- (c) the assessee who is claiming refund
- (d) (a) or (b)

Ans. (d) (a) or (b)

Chapter 13

Assessment

Sections	Rules
59. Self-assessment	98. Provisional Assessment
60. Provisional assessment	99. Scrutiny of returns
61. Scrutiny of returns	100. Assessment in certain cases
62. Assessment of non-filers of returns	
63. Assessment of unregistered persons	
64. Summary assessment in certain special cases	

Statutory Provisions

59. Self-assessment

Every registered taxable person shall self assess the taxes payable under this Act and furnish a return for each tax period as specified under Section 39.

Related provisions of the Statute

Section or Rule	Description
Section 2(94)	Definition of Registered Person
Section 2(97)	Definition of Return
Section 39	Furnishing of returns
Chapter VIII of the CGST Rules, 2017	Returns

59.1 Introduction

In terms of Section 2(11) of the Act, “assessment” means determination of tax liability under this Act and includes self-assessment, re-assessment, provisional assessment, summary assessment and best judgement assessment. It is important to note that there is no provision permitting a Proper Officer to re-assess the tax liability of taxable person. The provisions of the law permit a registered person to rectify any incorrect particulars furnished in the returns. In terms of Section 39(9), if a registered person discovers any omission or incorrect particulars furnished in a return, he is required to rectify such omission or incorrect particulars in the return to be furnished for the tax period during which such omission or incorrect particulars as are noticed (on payment of due interest), unless the same is as a result of scrutiny, audit, inspection or enforcement activity by the tax authorities, or such rectification is time barred

(i.e., after the due date for furnishing of return for the month of September or second quarter following the end of the financial year, or the actual date of furnishing of relevant annual return, whichever is earlier). As such, reference to such re-assessment in the definition may have to be suitably read down.

It is normally understood that an Assessment is conducted by a proper officer. In terms of Section 2(91) of the CGST Act, 2017 a “proper officer” in relation to any function to be performed under this Act, means the Commissioner or the officer of the central tax who is assigned that function by the Commissioner in the Board;

The CGST Act contemplates the following types of Assessments:

- Self-assessment (Section 59)
 - Provisional Assessment (Section 60)
 - Scrutiny of returns filed by registered taxable persons (Section 61)
 - Assessment of non-filers of returns (Section 62)
 - Assessment of unregistered persons (Section 63)
 - Summary Assessment in certain special cases (Section 64)
- (i) Self-assessment in terms of Section 59 refers to the assessment made by registered person himself / itself while all other assessments are undertaken by tax authorities.
- (ii) Provisional Assessment under Section 60 is an assessment undertaken at the instance of the registered person. Provisional Assessment is followed by a final Assessment.
- (iii) Scrutiny Assessment under section 61 is a form of re-assessment (since the self-assessment is made by the registered person himself / itself. A scrutiny of returns conducted by the proper officer who checks for the correctness of the returns filed and intimates the registered person of any discrepancies noticed.
- (iv) Assessment of non-filers u/s 62 and Assessment of un-registered person u/s 63 are in the nature of best judgement assessments.
- (v) Summary Assessment under Section 64 is a form of protective assessment based on information gathered from the tax authorities in a particular case.

59.2 Analysis

Self-assessment means an assessment by the registered person himself and not an assessment conducted or carried out by the Proper Officer. The GST regime continues to promote the scheme of self-assessment. Hence, every registered person would be required to assess his tax dues in accordance with the provisions of GST Act and report the basis of calculation of tax dues to the tax administrators, by filing periodic tax returns.

The provisions of the law permit a registered person to rectify any incorrect particulars furnished in the returns. In terms of Section 39(9), if a registered person discovers any omission or incorrect particulars furnished in a return, he is required to rectify such omission

or incorrect particulars in the return to be furnished for the tax period during which such omission or incorrect particulars are noticed (on payment of due interest), unless the same is as a result of scrutiny, audit, inspection or enforcement activity by the tax authorities, or such rectification is time barred (i.e., after the due date for furnishing of return for the month of September or second quarter following the end of the financial year, or the actual date of furnishing of relevant annual return, whichever is earlier). Further, Para 4 of Circular 26/2017 dated 29.12.17, clarifies that in case of summary returns like GSTR-3B, where there are no separate tables for reflecting tax effects of amendments for past periods are available, the figures pertaining to the current month can be adjusted for past month amendments, so long as the amount is not negative. These provisions exhort the concept of self-assessment.

59.3 Comparative Review

The principles of self-assessment were contained in Central Excise Law, Service Tax Law as well as VAT Laws.

Rule 6 of Central Excise Rules, provides that the assessee shall himself assess the duty payable on excisable goods (except in the case of cigarettes). As regards service tax, the concept of self-assessment is envisaged in Section 70 of the Act which provides that every person liable to pay service tax shall himself assess the tax due on services provided by him. State VAT laws also provide for filing of returns and payment of VAT on self-assessment basis [For instance, Section 20 of MVAT Act, 2002 or Section 38 of the Karnataka VAT Act, 2003]

59.4 Related provisions

Section	Rule	Form
Self-Assessment by Regular Assessee and Casual Taxable Person u/s 39(1)	61	Form GSTR 3 & 3B
Self-Assessment by Composition Dealer u/s 39(2)	62	Form GSTR 4
Self-Assessment by Non-Resident Taxable Person u/s 39(5)	63	Form GSTR 5
Self-Assessment of OIDARS provided by person located outside India to non-taxable person in India u/s 39(1)	64	Form GSTR 5A
Self-Assessment by ISD u/s 39(4)	65	Form GSTR 6
Self-Assessment of Tax Deducted At Source u/s 39(3)	66	Form GSTR 7
Self-Assessment of Tax Collected At Source u/s 52(4)	67	Form GSTR 8
Self-Assessment for purpose of Refund by persons having UIN u/s 39(1)	82	Form GSTR 11

59.5 Issues and Concerns

In respect of discharge of any additional tax liability that may arise on account of any re-working or re-computation etc., (for example - Reversal of input tax credit on account of obtaining completion certificate required under any law for the time being in force by a builder in the construction sector), the proportionate input tax credit ought to be reversed (in the

above example, in case of unsold flats). The quantum of reversal of taxes relating to the pre-GST regime cannot be reflected in the GST returns, since the credits have been availed under the erstwhile laws (which may or may not have been carried forward as transitional credit). In so far as GST returns are concerned (presently GSTR-3B), the return does not permit / allow a registered person to enter the proportionate reversal of Credit.

59.6 FAQs

Q1. Who is the person responsible to make self-assessment of taxes payable under the Act?

Ans. Every registered person shall self-assess the taxes payable under this Act and furnish a return for each tax period as specified under Section 39.

Statutory Provisions

60. *Provisional Assessment*

- (1) *Subject to the provision of sub-section (2), where the taxable person is unable to determine the value of goods or services or both or determine the rate of tax applicable thereto, he may request the proper officer in writing giving reasons for payment of tax on a provisional basis and the proper officer shall pass an order within a period not later than ninety days from the date of receipt of such request, allowing payment of tax on provisional basis at such rate or on such value as may be specified by him.*
- (2) *The payment of tax on provisional basis may be allowed, if the taxable person executes a bond in such form as may be prescribed, and with such surety or security as the proper officer may deem fit, binding the taxable person for payment of the difference between the amount of tax as may be finally assessed and the amount of tax provisionally assessed.*
- (3) *The proper officer shall, within a period not exceeding six months from the date of the communication of the order issued under sub-Section (1), pass the final assessment order after taking into account such information as may be required for finalizing the assessment.*
Provided that the period specified in this sub-section may, on sufficient cause being shown and for reasons to be recorded in writing, be extended by the Joint/Additional Commissioner for a further period not exceeding six months and by the Commissioner for such further period not exceeding four years.
- (4) *The registered person shall be liable to pay interest on any tax payable on the supply of goods or services or both under provisional assessment but not paid on the due date specified under subsection (7) of section 39 or the rules made thereunder, at the rate specified under sub-Section (1) of Section 50, from the first day after the due date of payment of tax in respect of the said supply of goods or services or both till*

the date of actual payment, whether such amount is paid before or after the issuance of order for final assessment.

- (5) *Where the registered person is entitled to a refund consequent to the order of final assessment under sub-Section (3), subject to the provisions of sub-Section (8) of Section 54, interest shall be paid on such refund as provided in Section 56.*

Extract of the CGST Rules, 2017

98. Provisional Assessment

- 1) *Every registered person requesting for payment of tax on a provisional basis in accordance with the provisions of sub-section (1) of section 60 shall furnish an application along with the documents in support of his request, electronically in FORM GST ASMT-01 on the common portal, either directly or through a Facilitation Centre notified by the Commissioner.*
- 2) *The proper officer may, on receipt of the application under sub-rule (1), issue a notice in FORM GST ASMT-02 requiring the registered person to furnish additional information or documents in support of his request and the applicant shall file a reply to the notice in FORM GST ASMT – 03, and may appear in person before the said officer if he so desires.*
- 3) *The proper officer shall issue an order in FORM GST ASMT-04 allowing the payment of tax on a provisional basis indicating the value or the rate or both on the basis of which the assessment is to be allowed on a provisional basis and the amount for which the bond is to be executed and security to be furnished not exceeding twenty-five per cent. of the amount covered under the bond.*
- 4) *The registered person shall execute a bond in accordance with the provisions of subsection (2) of section 60 in FORM GST ASMT-05 along with a security in the form of a bank guarantee for an amount as determined under sub-rule (3):*

Provided that a bond furnished to the proper officer under the State Goods and Services Tax Act or Integrated Goods and Services Tax Act shall be deemed to be a bond furnished under the provisions of the Act and the rules made thereunder.

Explanation. - For the purposes of this rule, the expression “amount” shall include the amount of integrated tax, central tax, State tax or Union territory tax and cess payable in respect of the transaction.

- 5) *The proper officer shall issue a notice in FORM GST ASMT-06, calling for information and records required for finalization of assessment under sub-section (3) of section 60 and shall issue a final assessment order, specifying the amount payable by the registered person or the amount refundable, if any, in FORM GST ASMT-07.*
- 6) *The applicant may file an application in FORM GST ASMT- 08 for the release of the*

security furnished under sub-rule (4) after issue of the order under sub-rule (5).

- 7) *The proper officer shall release the security furnished under sub-rule (4), after ensuring that the applicant has paid the amount specified in sub-rule (5) and issue an order in FORM GST ASMT-09 within a period of seven working days from the date of the receipt of the application under sub-rule (6).*

Relevant circulars, notifications, clarifications, flyers issued by Government:

1. *Chapter Thirty-One of the compilation of the GST Flyers as issued by the CBEC can be referred to for a gist of the statutory provisions, titled 'Provisional Assessment in GST'.*

Related provisions of the Statute

Section or Rule	Description
Section 2(11)	Definition of assessment
Section 39	Furnishing of returns
Section 50	Interest on delayed payment of tax
Section 54	Refund of Tax
Section 56	Interest on delayed refunds

60.1 Introduction

Provisional assessment can be resorted to in the following situations:

- (i) When a taxable person is unable to determine the Value of goods or services - viz, there is a difficulty in ascertaining:
- Transaction value to be adopted for determination of tax payable; e.g. open market value to be determined, where consideration is not wholly in money or where supplier enters into cost plus contract with the buyer.
 - Inclusion or exclusion of any amounts in the value of supply; e.g. as per pre existing agreement certain percentage of discount to be allowed to buyer depending upon the buying targets achieved by them.
 - Existence of any circumstance causing failure of transaction value declared e.g. where the supplier is concerned whether the price of the supply can be regarded as the sole consideration for the supply, if the supply has been effected based on a certain promise made by the recipient, for which the monetary value is indeterminable.
- (ii) Rate of tax applicable on the supply cannot be determined by the taxable person, viz there is difficulty in ascertaining:
- Classification of the goods and / or services under the relevant Schedule;

- Eligibility to any exemption notification u/s 11 or compliance with conditions associated with such exemption.
- Applicability of any abatement/deduction in rate of tax to the assessee u/s 9 or compliance of conditions associated with such abatement.

60.2 Analysis

The facility of provisional assessment is available only in the cases of Valuation and determination of rate of tax. The provisions of this section cannot be extended for any other purposes or subject matter. For example, there may be uncertainty about the kind of tax (IGST or CGST-SGST) applicable, time of supply, supplies to be treated as “supply of goods” or “supply of services”, [determination of mixed or composite supply is a rate dispute], admissibility of ITC, quantum of reversal of IT, whether a particular action is supply or not. In the aforesaid kind or classes of cases, recourse is not available to provisional assessment.

Procedure

- (i) In terms of Rule 98(1), the process of provisional assessment commences on furnishing of an application by the registered person along with the necessary supporting documents in FORM GST ASMT-01, electronically through the common portal. The provisional assessment cannot be resorted to by the proper officer on *suo-motu* basis.
- (ii) The proper officer will thereafter issue a notice in FORM GST ASMT-02. As per ASMT-2, reply is required to be given within 15 days to the registered person and if required seek additional information or documents. At this stage the proceedings are deemed to have commenced and the applicant is required to file his objections / make submissions in FORM GST ASMT – 03. The registered person can also appear in person and be heard provided he makes a specific request for a personal hearing.
- (iii) On due consideration of the reply so filed, and after providing a reasonable opportunity of being heard the proper officer must issue an order in FORM GST ASMT-04, by allowing payment of tax on provisional basis, indicating the value or rate or both on the basis of which assessment is allowed on a provisional basis. The proper officer, in the normal course, cannot pass an order rejecting the application of provisional assessment. Since section 60(1) employs the term ‘shall’ pass order ‘allowing’ payment of tax provisionally. The word “shall” in this circumstance cannot be construed as “may”.
- (iv) The order so passed should also indicate the amount for which bond has to be executed in **Form GST ASMT – 05** by the applicant. The security has to be furnished in the form of bank guarantee not exceeding 25% of the bond ‘amount’ which shall include IGST, CGST, SGST or UTGST and cess (if any) payable in respect of the transaction. A bond furnished to the proper officer under State Goods and Services Tax Act or Integrated Goods and Services Tax Act shall be deemed to be a bond furnished under the provisions of Central Goods and Service Tax Act and the rules made thereunder.

As per Form GST ASMT-5, if the bond and security is not provided within the period specified in notice, the provisional assessment shall lapse.

Finalization of provisional assessment

Once the above process is complete, the proper officer by issue of a notice in **FORM GST ASMT-06**, will call for information and records required for finalization of assessment. On conclusion of the due process of hearing, a final assessment order shall be passed by the proper officer in **FORM GST ASMT-07**, specifying the amount payable or refundable to the registered person within a period of 6 months from the date of communication of provisional assessment order. However, on sufficient cause being shown and for reasons to be recorded in writing, this period can be extended by Joint / Additional Commissioner or by the Commissioner for such further period as mentioned below:

Additional / Joint Commissioner	Maximum of 6 months
Commissioner	Maximum of 4 years

It may be noted that, in the statement of outward supply to be furnished by a registered person under section 37(1) i.e. in Form GSTR-1, the invoices in respect of which tax is paid under provisional assessment is required to be mentioned.

Interest liability

If the amount of tax determined to be payable under final assessment order, is more than the tax which is already paid along with the return filed in terms of section 39, the registered person shall be liable to pay interest on the shortfall, at the rates specified in Section 50(1) of the Act [i.e. @18%], from the first day after due date of payment of tax in respect of the said goods and /or services or both, till the date of actual payment, irrespective of whether such shortfall is paid before or after the issuance of order for final assessment¹. Likewise, when the registered person is entitled to refund consequent upon the order for final assessment, interest shall be paid on such refund at the rates specified in proviso to Section 56 @ 9% because refund is arising out of order of adjudicating authority. The interest on refund shall run from 61st date from the date of receipt of application for refund till the date of refund.

As such, the registered person must avail this opportunity of provisional assessment after much thought and careful consideration. Any claim for refund of taxes paid in excess under this section would be processed in accordance with Section 54 (refund provision), and is subject to the concept of "unjust enrichment u/s 54(8) (e). Hence if where the registered person has not borne the incidence of tax and has passed on the burden to some other person, then instead of granting refund to the applicant, it shall be credited to consumer

¹ To overcome the decision of Ceat Limited V. CCE, 2015 (317) ELT 192 (Bom), maintained by the Supreme Court in Commissioner V. Ceat Ltd., 2016 (342) ELT A181 (SC)

welfare fund. Except for authorizing refund, this section does not by itself permit grant of refund. The application for refund is required to be made within 2 years from the relevant date defined in clause (f) of Explanation 2 to Section 54 i.e. within 2 years from the date of adjustment of tax after the final assessment.

Release of Security consequent to Finalization

On conclusion of the final assessment order the applicant can file an application under Rule 98(6) in **FORM GST ASMT- 08** for release of security furnished. On receipt of such application, the proper officer ought to release the security furnished, after ensuring that the payment of the amount specified in the final assessment order and issue an order in **FORM GST ASMT-09**. This order has to be issued within a period of 7 working days from the date of receipt of the application for release of security.

60.3 Comparison with equivalent provisions under other laws:

Section 60 of the CGST Act, is broadly drafted on the lines of the erstwhile provisions of Central Excise and Service Tax law. A provisional assessment is permitted under Central Excise Act and also under the Finance Act 1994, and is governed by the procedure contained in Rule 7 of the Central Excise Rules or as the case may be, Rule 6(4)/(4A)/(4B)/(5) of Service Tax Rules. Under both these Acts, provisional assessment is carried out only at the instance of the assessee.

Under the State VAT Acts, the concept of provisional assessment “at the instance of assessee”, is not prevalent. Some State Acts have used this term to cover the cases of best-judgment assessment done by the tax authorities, in the absence of returns or records. For example, refer Section 32 of Gujarat Value Added Tax Act or Section 40 of the Orissa Value Added Tax Act.

60.4 Issues and Concerns

The provisional assessment provides a discretionary power to Joint Commissioner or Additional commissioner and Commissioner to extend the proceedings or pass the order or decree upto 6 months or 4 years. If for any reasons, the time limit stands extended till the 4th year, the registered person shall have to pay interest from the due date of original return filed under Section 39(7) of the CGST Act, 2017, inspite of the taxable person paying tax as per provisional order passed by proper officer.

60.5 FAQs

Q1. When is a taxable person permitted to pay tax on a provisional basis?

Ans. Tax payments can be made on a provisional basis only when a proper officer passes an order for permitting the same. For this purpose, the registered person has to make a written request to the proper officer, giving reasons for payment of tax on a provisional basis. The reasons for this purpose may be a case where the registered person is unable to determine the value of goods and/ or services or determine the applicable tax rate, etc. Further, the registered person may also be required to execute a bond in the prescribed form, and with such surety or security as the proper officer may deem fit.

Q2. What is the latest time by which final assessment is required to be made?

Ans. It is the responsibility of the proper officer to pass the final assessment order after taking into account such information as may be required for finalizing the assessment, within six months from the date of the communication of the order for provisional assessment. However, on sufficient cause being shown and for reasons to be recorded in writing, the timelines may be extended by the Joint/Additional Commissioner for a further period not exceeding six months and by the Commissioner for such further period not exceeding 4 years as he may deem fit.

60.6 MCQs

Q1. Where the tax liability as per the final assessment is higher than tax paid, at the time of filing of return u/s 39 the registered person shall_____.

- (a) not be liable to interest, provided he proves that his actions were bonafide
- (b) be liable to pay interest from due date till the date of actual payment
- (c) be liable to pay interest from date of the final assessment till the date of actual payment
- (d) be liable to pay interest from due date till the date of the final assessment

Ans. (b) be liable to pay interest from due date till the date of actual payment

Q2. Provisional assessment under the GST law is permitted to be:

- (a) At the instance of the taxable person
- (b) At the instance of the tax authorities on a best judgment basis in absence of adequate details or response from registered person
- (c) Either of (a) and (b)
- (d) Available only to certain notified persons

Ans. (a) At the instance of the taxable person

Q3. On the grounds of sufficient reasons being provided by proper officer the time period for

passing final assessment order can be extended by Joint/ Additional Commissioner for further period of not exceeding

- (a) 2 months
- (b) 4 months
- (c) 6 months
- (d) No time limit.

Ans. (c) 6 months

Q4. On the grounds of sufficient reasons being provided by proper officer the time period for passing final assessment order can be extended by Commissioner for further period of

- (a) 2 months
- (b) 4 years
- (c) 6 months
- (d) No time limit.

Ans. (b) 4 years

Statutory Provisions

61. Scrutiny of Returns

- (1) *The proper officer may scrutinize the return and related particulars furnished by the registered person to verify the correctness of the return and inform him of the discrepancies noticed, if any, in such manner as may be prescribed and seek his explanation thereto.*
- (2) *In case the explanation is found acceptable, the registered person shall be informed accordingly and no further action shall be taken in this regard.*
- (3) *In case no satisfactory explanation is furnished within a period of thirty days of being informed by the proper officer or such further period as may be permitted by him or where the taxable person, after accepting the discrepancies, fails to take the corrective measure in his return for the month in which the discrepancy is accepted, the proper officer may initiate appropriate action including those under Section 65 or Section 66 or Section 67, or proceed to determine the tax and other dues under Section 73 or Section 74.*

Extract of the CGST Rules, 2017

99. Scrutiny of returns

- 1) *Where any return furnished by a registered person is selected for scrutiny, the proper officer shall scrutinize the same in accordance with the provisions of section 61 with reference to the information available with him, and in case of any discrepancy, he shall issue a notice to the said person in FORM GST ASMT-10,*

<p><i>informing him of such discrepancy and seeking his explanation thereto within such time, not exceeding thirty days from the date of service of the notice or such further period as may be permitted by him and also, where possible, quantifying the amount of tax, interest and any other amount payable in relation to such discrepancy.</i></p> <p>2) <i>The registered person may accept the discrepancy mentioned in the notice issued under sub-rule (1), and pay the tax, interest and any other amount arising from such discrepancy and inform the same or furnish an explanation for the discrepancy in FORM GST ASMT- 11 to the proper officer.</i></p> <p>3) <i>Where the explanation furnished by the registered person or the information submitted under sub-rule (2) is found to be acceptable, the proper officer shall inform him accordingly in FORM GST ASMT-12.</i></p>
--

Related provisions of the Statute

Section or Rule	Description
Section 2(97)	Definition of Return
Chapter IX of the CGST Act	Returns
Section 65	Audit by tax authorities.
Section 66	Special audit.
Section 67	Power of inspection, search and seizure.
Section 73	Determination of tax not paid or short paid or erroneously refunded or input tax credit wrongly availed or utilised for any reason other than fraud or any wilful-misstatement or suppression of facts.
Section 74	Determination of tax not paid or short paid or erroneously refunded or input tax credit wrongly availed or utilised by reason of fraud or any wilfull-misstatement or suppression of facts.

61.1 Introduction

Section 61 deals with the powers vested in the proper officer to scrutinize the returns filed by registered persons with a view to verifying the correctness of the return. In legal parlance, it is considered to be a pre-adjudication process. The process of adjudication is provided in Sections 73 to 75 of the Act.

61.2 Analysis

When a return furnished by a registered person is selected for scrutiny, the proper officer scrutinizes the same with reference to the information available with him, and in case of any

discrepancy, he shall issue a notice to the said person in FORM GST ASMT-10, under Rule 99(1), informing him of such discrepancy and seeking his explanation thereto. The proper officer shall quantify the amount of tax, interest and any other amount payable in relation to such discrepancy, wherever possible.

An explanation shall be furnished by the registered person, in reply to the aforesaid notice, within a maximum period of thirty days from the date of service of the notice or such further period as may be permitted by the proper officer.

The registered person may accept the discrepancy mentioned in the notice issued under Rule 99(1), and pay the tax, interest and any other amount arising from such discrepancy and inform the same OR furnish an explanation for the discrepancy in FORM GST ASMT- 11 to the proper officer.

Where the explanation furnished by the registered person or the information submitted under Rule 99(2) is found to be acceptable, the proper officer shall inform the registered period in FORM GST ASMT-12.

In case, explanation is not furnished OR explanation furnished is not satisfactory, OR after accepting discrepancies, the registered person fails to take corrective measures, in his return for the month in which the discrepancy is accepted by him, the proper officer, may, take recourse to any of the following provisions:

- Initiate departmental audit as per section 65 of the Act; or
- Initiate Special Audit as per section 66
- Initiate inspection, search and seizure as per section 67 of the Act
- Issue show cause notice u/s 73 & 74 of the CGST Act.

The first stage in return scrutiny denotes a *prima facie* scrutiny, in order to ascertain whether the information furnished by the assessee in returns is *prima facie* valid and not internally inconsistent or inadequate. The second stage appears to be a detailed assessment calling for records and determination of tax liability under sections 73 to 75.

While doing so, the proper officer is entitled to exercise the powers vested in him under section 67 of the Act, which deals with power of inspection, search and seizure.

From the language employed in section 67, it appears that these powers are required to be exercised not in routine manner, but only under circumstances when there is reasonable belief regarding suppression or intention to evade tax.

It's important to note that, section 61(3) empathetically provides that, in case the explanation given by the tax payer in response to discrepancies informed by the proper officer, if found acceptable, the registered person shall be informed accordingly in **FORM GST ASMT-12** and no further action shall be taken in this regard.

61.3 Comparative Review

The provisions as to scrutiny of returns were also present in Service Tax / Central Excise and State VAT laws. For example, Rule 12(3) of Central Excise Rules provided that, the 'Proper Officer' may on the basis of information contained in the return filed by the assessee under rule 12(1), and after such further enquiry as he may consider necessary, scrutinize the correctness of the duty assessed by the assessee on the goods removed, in the manner to be prescribed by the Board. CBEC has issued guidelines for detailed scrutiny of Central Excise Returns vide Circular No. 1004/11/2015-CX, dated 21-7-2015 and also issued guidelines for detailed scrutiny of service tax returns vide Circular No, 18/4/2015-ST dated 30-06-2015

61.4 Issues and Concerns

During the filing of returns the registered person should ensure that the value of exempted supplies as well as non-taxable supplies, if any, made by him is properly disclosed or else the same may be considered as suppression of information and a notice under section 73 or 74 would stand issued or the proper officer can take recourse for conducting an audit or special audit, as the case may be.

61.5 FAQs

Q1. Describe the recourse that may be taken by the officer in case proper explanation is not furnished for the discrepancy in the return.

Ans. In case, satisfactory explanation is not obtained or after accepting discrepancies, registered person fails to take corrective measures, in his return for the month in which the discrepancy is accepted by him, the Proper Officer may take recourse to any of the following provisions:

- (a) Conduct audit at the place of business of registered person in a manner provided in Section 65 of the Act, or;
- (b) Direct such registered person by notice in writing to provide his records including audited books of account examined and audited by a Chartered Accountant or Cost Accountant under Section 66 of the Act or ;
- (c) Undertake procedures of inspection, search and seizure under Section 67 of the Act; and
- (d) Issue notice under Sections 73 to 75 of the Act.

Q2. What does Section 61 deal with?

Ans. Section 61 deals with scrutiny of returns filed by registered persons to verify the correctness of such returns.

Q3. What is the proper officer required to do, if the information obtained from assessee u/s 61 is found satisfactory?

Ans. In case the explanation is found acceptable, the registered person shall be informed accordingly in Form GST ASMT-12 and no further action shall be taken in this regard.

61.6 MCQs

Q1. Where the tax authorities notice a discrepancy in the details during the scrutiny of returns, the registered person:

- (a) would be liable for interest if he is unable to prove that the discrepancy did not arise on his account and it was a fault of another person
- (b) is required to provide satisfactory/ acceptable explanation for the same within 30 days or any extended timelines as may be permitted
- (c) must prepare documents to cover up the discrepancy.
- (d) Both (a) and (b)

Ans. (b) is required to provide satisfactory/ acceptable explanation for the same within 30 days or any extended timelines as may be permitted

Q2. If the information obtained from taxable person is not found satisfactory by the proper officer, he can pass assessment order u/s 61 raising demand of disputed tax demand.

- (a) True
- (b) False

Ans. (b) False

Q3. What is the time limit after which action under section 61 cannot be taken?

- (a) 30 days from filing of return or such further period as may be decided by proper officer.
- (b) No time Limit
- (c) Time limit mentioned in Section 73 or 74 of the Act.

Ans. (c) Time limit mentioned in Section 73 or 74 of the Act.

Q.4 What is the time limit, within which the registered person should take corrective measures after accepting the discrepancies communicated to him by proper officer?

- (a) reasonable time
- (b) 30 days from the date of communication of discrepancy.
- (c) 30 days from date of acceptance of the discrepancy
- (d) date of filing of return for the month in which the discrepancy is accepted

Ans. (d) date of filing of return for the month in which the discrepancy is accepted.

Statutory Provisions**62. Assessment of non-filers of returns**

- (1) *Notwithstanding anything to the contrary contained in section 73 or section 74, where a registered taxable person fails to furnish the return under Section 39 or Section 45, even after the service of a notice under Section 46, the proper officer may proceed to assess the tax liability of the said person to the best of his judgement taking into account all the relevant material which is available or which he has gathered and issue an assessment order within a period of five years from the date specified under Section 44 for furnishing of the annual return for the financial year to which the tax not paid relates.*
- (2) *Where the registered person furnishes a valid return within thirty days of the service of the assessment order under sub-Section (1), the said assessment order shall be deemed to have been withdrawn but the liability for payment of interest under sub-section (1) of section 50 or for the payment of late fee under section 47 shall continue.*

Extract of the CGST Rules, 2017**100. Assessment in certain cases**

- (1) *The order of assessment made under sub-section (1) of section 62 shall be issued in FORM GST ASMT-13 and a summary thereof shall be uploaded electronically in FORM GST DRC-07.*
- (2) *The proper officer shall issue a notice to a taxable person in accordance with the provisions of section 63 in FORM GST ASMT-14 containing the grounds on which the assessment is proposed to be made on best judgment basis and shall also serve a summary thereof electronically in FORM GST DRC-01, and after allowing a time of fifteen days to such person to furnish his reply, if any, pass an order in FORM GST ASMT-15 and summary thereof shall be uploaded electronically in FORM GST DRC07.*
- (3) *The order of assessment under sub-section (1) of section 64 shall be issued in FORM GST ASMT-16 and a summary of the order shall be uploaded electronically in FORM GST DRC-07.*
- (4) *The person referred to in sub-section (2) of section 64 may file an application for withdrawal of the assessment order in FORM GST ASMT-17.*
- (5) *The order of withdrawal or, as the case may be, rejection of the application under sub-section (2) of section 64 shall be issued in FORM GST ASMT-18.*

Relevant circulars, notifications, clarifications, flyers issued by Government: NA

Related provisions of the Statute

Section or Rule	Description
Section 2(97)	Definition of Return
Section 2(11)	Definition of Assessment
Section 39	Furnishing of returns.
Section 44	Annual return
Section 45	Final return
Section 47	Levy of late fee.
Section 50	Interest on delayed payment of tax.
Section 73	Determination of tax not paid or short paid or erroneously refunded or input tax credit wrongly availed or utilised for any reason other than fraud or any wilful-misstatement or suppression of facts.
Section 74	Determination of tax not paid or short paid or erroneously refunded or input tax credit wrongly availed or utilised by reason of fraud or any wilful-misstatement or suppression of facts.

62.1 Introduction

This section commences with a *non obstante* clause, meaning whenever the provisions of section 73 or 74 applies, the provisions of section 62 of the Act cannot be invoked. However, the provisions of section 62 can be invoked only in case of registered taxable persons who have failed to file returns, as required, under section 39 or as the case may be, or final return on cancellation of registration under section 45 of the Act. Issuance of notice under section 46 appears to be a pre-condition for initiating proceedings under Section 62 of the Act. However, Section 62 can not be invoked for non-filing GSTR-1, GSTR-2 and GSTR-9.

62.2 Analysis of Provisions

Non-compliance with the notice issued under Section 46 paves the way for initiating the proceedings under this section. If the assessee fails to furnish the return within 15 days of issue of notice under section 46 then the Proper Officer may assess the tax liability in accordance with the provisions of Rule 100 i.e. to the best of his judgment, taking into account all the relevant material available on record, and issue an assessment order. This is also known as 'best judgment assessment'. It can be completed without giving notice of hearing to the assessee. However best judgment assessment should be made on the basis of material available or material gathered by proper officer.

Please note that only returns under 39 and 45 are covered by section 62. In other words, non-filing of GSTR 3 (Or 3B) and GSTR 10 (final return) will attract best judgement assessment. Failure to file GSTR 1 does not attract section 62. Reference may be had to newly enacted

section 43A where outward supplies returned will be deemed to be tax payable and attracts recovery actions.

Order under section 62 must be issued within a period of five years from the date specified under section 44 for furnishing annual return for the financial year to which the tax not paid relates. Section 44(1) states that due date for furnishing the annual return is on or before 31st December following the end of financial year to which such annual return pertains.

Non-issuance of notice under Section 46 closes the door on invoking Section 62 although other provisions are available to recover the tax dues. If, however, a registered person furnishes a 'valid return' within 30 days of the service of assessment order, the said assessment order shall be deemed to be withdrawn. 'Valid return' is defined in Section 2(117) to mean a return filed under Section 39(1) of the Act on which self-assessed tax has been paid in full.

Section 62 starts with the words '*notwithstanding anything contrary to section 73 and 74*'. Section 73 and 74 mandates issue of SCN and providing opportunity of being heard before passing order for demanding tax. Further, tax can be demanded for the period as prescribed in section 74, if the existence of omissions and commissions, as mentioned u/s 74, are proved. The pre-condition of issuing SCN, providing opportunity of being heard for demanding tax for the period prescribed u/s 74 in the presence of omissions and commissions listed u/s 74 is sought to be overcome by the non-obstante clause u/s 62. The assessment u/s 62 however can be made only upto 5 years from the due date of furnishing of annual return u/s 44. Consequence of late fee under Section 47 and interest under Section 50 will both be applicable in cases of conclusion of best judgement assessment made under this Section, even if the assessment order u/s 62 is withdrawn.

An order passed under this section shall be communicated to the registered person in **FORM GST- ASMT 13**

62.3 Comparison with equivalent provisions in other laws

It appears that section 62 of the CGST Act is incorporated predominantly on the basis of provisions contained in the erstwhile State VAT Acts.

Section 72 of the Finance Act, 1994 provides for assessment of persons liable to pay service tax, but who has failed to furnish return under section 70, of the Act. However, procedure contained in section 72 requires that every such person shall be given a reasonable opportunity of being heard before the order is passed.

62.4 Issues and Concerns

The consequence of non-filing of returns may lead to adverse GST compliance rating which will have an impact on the matters such as claiming of refund. Registered persons who are non-filers of returns will always be under the scanner of the authorities for every activity carried out by such registered person. Further, it also affects the vendor relationship due to non-compliance of the provisions of the GST laws.

A non-filer would not have filed his periodic returns and therefore the Annual returns in Form 9 and Annual Audit in Form 9C would not be possible. However, if they have filed returns for part of the year then Annual returns could be filed considering such filed returns and based on his books of accounts.

62.5 FAQs

Q1. Whether Proper Officer is required to give any notice to taxable person before completing assessment u/s 62?

Ans. The assessment u/s 62 can be initiated only after the service of notice under section 46 i.e. notice to return defaulters.

Q2. If a registered person files a return after receipt of notice u/s 46 but fails to make the payment disclosed by him in the return, can assessment order u/s 62 be passed in this case?

Ans. An assessment order u/s 62 is deemed to have been withdrawn if the registered person furnishes a valid return (including payment of taxes).

62.6 MCQs

Q1. The proper officer can complete assessment under section 62 without issuing any notice to the registered taxable person before passing assessment order.

- (a) True
- (b) False

Ans. (b) False

Q2. What is the time limit for issuing order under section 62?

- (a) 9 months from the end of financial year.
- (b) 3 years for cases covered U/s 73 or 5 years for cases covered under 74
- (c) 5 years for cases covered U/s 73 or 3 years for cases covered under 74
- (d) 5 years from the due date of filing annual return.

Ans. (d) 5 years from the due date of filing annual return

Q3. The assessment order u/s 62 shall be deemed to be cancelled if:

- (a) Where the registered person furnishes a valid return within 30 days of the service of the assessment order.
- (b) Where the registered person within 90 days of the service of the assessment order.
- (c) Assessment order under section 46 cannot be cancelled.
- (d) Where assessee intimates to the Proper Officer that he has filed the valid return.

Ans. (a) Where the registered person furnishes a valid return within 30 days of the service of the assessment order.

Q4. After serving of notice u/s 46, the proper officer is not required to give notice of hearing to the registered tax person before passing assessment order.

(a) True

(b) False

Ans. (a) True.

Statutory Provisions

63. Assessment of unregistered persons

Notwithstanding anything to the contrary contained in section 73 or section 74, where a taxable person fails to obtain registration even though liable to do so, or whose registration has been cancelled under sub section (2) of section 29 but who was liable to pay tax, the proper officer may proceed to assess the tax liability of such taxable person to the best of his judgement for the relevant tax periods and issue an assessment order within a period of five years from the date specified under section 44 for furnishing of the annual return for the financial year to which the tax not paid relates.

Provided that no such assessment order shall be passed without giving the person an opportunity of being heard.

Extract of the CGST Rules, 2017

100. Assessment in certain cases.

2) *The proper officer shall issue a notice to a taxable person in accordance with the provisions of section 63 in **FORM GST ASMT-14** containing the grounds on which the assessment is proposed to be made on best judgment basis and after allowing a time of fifteen days to such person to furnish his reply, if any, pass an order in **FORM GST ASMT- 15**.*

Relevant circulars, notifications, clarifications, flyers issued by Government: NA

Related provisions of the Statute

Section or Rule	Description
Section 2(11)	Definition of Assessment
Section 22	Person liable for Registration
Section 24	Compulsory Registration
Section 29	Cancellation of Registration
Section 44	Annual return

Section 73	Determination of tax not paid or short paid or erroneously refunded or input tax credit wrongly availed or utilised for any reason other than fraud or any wilful-misstatement or suppression of facts.
Section 74	Determination of tax not paid or short paid or erroneously refunded or input tax credit wrongly availed or utilised by reason of fraud or any wilfull-misstatement or suppression of facts.

63.1 Introduction

This section commences with a *non obstante* clause, meaning whenever the provisions of section 73 or 74 applies, the provisions of section 63 of the Act cannot be invoked. This Section is applicable to unregistered persons i.e., persons who are liable to obtain registration under Section 22 and have failed to obtain registration, will come within scope of operation of this Section. This provision also covers cases where registration was cancelled under section 29(2). Section 29(2) of the Act covers 5 instances where registration may be cancelled by proper officer:

- (a) A person who contravenes the provisions of this Act or Rules made thereunder; or
- (b) A composition person who fails to furnish returns for 3 consecutive tax periods; or
- (c) A person other than composition person who fails to furnish returns for 6 consecutive months or
- (d) A person who has sought voluntary registration but has failed to commence business within 6 months; or
- (e) Where registration has been obtained by way of fraud, willful misstatement or suppression of facts.

63.2 Analysis

This Section is applicable to unregistered taxable persons. In such cases, proper officer is required to provide a reasonable opportunity of being heard to such person before proceeding to assess such person. This section begins with the phrase "Notwithstanding anything to the contrary contained in section 73 or section 74". It therefore appears that, assessment under section 63 can be completed independent of section 73 and Section 74, however, procedures contained in section 73 or 74 to the extent they are not inconsistent with section 63 need to be followed, while completing the assessment on principles governing best judgment assessment. Even though no return would have actually been filed in such cases, the authority to pass such assessment order is extinguished on the expiry of 5 years from due date applicable for filing annual return for the financial year to which tax not paid relates.

For assessment under this section, notice has to be issued as per Rule 100(2) in **FORM GST ASMT-14** by the proper officer. The notice would contain the reasons / grounds on which

the assessment is proposed to be made on best judgment basis. The registered person is allowed a time period of 15 days to furnish his reply, if any. After considering the said explanation, the order has to be passed in **FORM GST ASMT- 15**.

63.3 Comparison with equivalent provisions in other laws:

Section 23(4) of the MVAT Act contains similar provision as that in Section 63 of the GST Act.

63.4 Issues and Concerns

The application of the aforesaid section is a discretionary power vested in the officer when it comes to his notice that a person although liable to registered has not obtained registration. The powers vested in the section 63 can be invoked only when the proper officer is in possession of information that is material for initiating the proceedings.

An unregistered person does not qualify as a registered person under section 2(94) of the CGST Act, 2017, hence annual return and audit is not applicable for him.

63.5 FAQs

Q1. What is the time limit for passing order u/s 63?

Ans. The proper officer has to pass an assessment order u/s 63 within a period of five years from the due date for filing the annual return for the financial year to which such tax unpaid relates to.

Q2. Can an assessment order be passed without affording an opportunity of being heard to the person liable to be registered?

Ans. No, an assessment order cannot be passed without giving him an opportunity of being heard.

63.6 MCQs

Q1. What is the time limit for passing order u/s 63?

- (a) 5 years from the date due date for filing of the annual return for the financial year to which tax not paid relates
- (b) 5 years from the end of financial year in which tax not paid relates to
- (c) No time limit

Ans. (a) 5 years from the date due date for filing of the annual return for the year to which tax not paid relates

Q2. No Notice is required to be given before passing assessment order under section 63?

- (a) True
- (b) False

Ans. (b) False

Q3. Section 63 deals with

- (a) Assessment of taxable persons who have failed to file the returns.
- (b) Assessment of registered taxable person who have filed returns as per the law.
- (c) Assessment of unregistered taxable persons.
- (d) Assessment of any taxable person, whether registered or unregistered.

Ans. (c) Assessment of unregistered taxable persons

Statutory Provisions

64. Summary assessment in certain special cases

- (1) *The proper officer may, on any evidence showing a tax liability of a person coming to his notice, with the previous permission of Additional/Joint Commissioner, proceed to assess the tax liability of such person to protect the interest of revenue and issue an assessment order, if he has sufficient grounds to believe that any delay in doing so may adversely affect the interest of revenue:*

Provided that where the taxable person to whom the liability pertains is not ascertainable and such liability pertains to supply of goods, the person in charge of such goods shall be deemed to be the taxable person liable to be assessed and liable to pay tax and any other amount due under this section.

- (2) *On any application made by the taxable person within thirty days from the date of receipt of order passed under sub-Section (1) or on his own motion, if the Additional or Joint Commissioner considers that such order is erroneous, he may withdraw such order and follow the procedure laid down in Section 73 or section 74.*

Extract of the CGST Rules, 2017

100. Assessment in certain cases.

- (1) The order of summary assessment under sub-section (1) of section 64 shall be issued in FORM GST ASMT-16.
- (2) The person referred to in sub-section (2) of section 64 may file an application for withdrawal of the summary assessment order in FORM GST ASMT-17.
- (3) The order of withdrawal or, as the case may be, rejection of the application under subsection (2) of section 64 shall be issued in FORM GST ASMT-18.

Relevant circulars, notifications, clarifications, flyers issued by Government: NA

Related provisions of the Statute

Section or Rule	Description
-----------------	-------------

Section 73	Determination of tax not paid, short paid, erroneously refunded or input tax credit wrongly availed or utilized for any reason other than fraud or any wilful misstatement or suppression of facts
Section 74	Determination of tax not paid, short paid, erroneously refunded or input tax credit wrongly availed or utilized by reason of fraud or any wilful misstatement or suppression of facts

64.1 Introduction

The word “summary assessment” is generally used in a tax legislation to denote ‘fast track assessment’ based on return filed by the assessee. It allows the Tax Officer to make prima facie adjustments based on errors or factors based on the available information without an occasion for calling for further information from an assessee or inspecting his records. In the GST Act, it is used to denote those assessments which are completed ex-parte and on priority basis when there is reason to believe that there will be loss of tax revenue, if such assessment is delayed. This provision is only the first step in invoking the machinery provided to enforce recovery of dues from potential defaulters, and this requires an assessment of the tax liability. Such amounts are commonly known as protective assessments which in a sense protects Government revenue. This section pre-supposes the fact that the proper officer must be in possession of sufficient grounds to believe that any delay will adversely affect revenue.

64.2 Analysis

The summary assessment can be undertaken in case the following conditions are satisfied:

- The Proper Officer must have evidence that there may be a tax liability; and
- The Proper Officer has obtained prior permission of Additional / Joint Commissioner to assess the tax liability summarily. The proper officer must have sufficient ground to believe that any delay in passing assessment order would result in loss of revenue.

Summary assessment under this Section of the CGST Act can therefore be construed in some sense as a ‘protective assessment’ carried out in special circumstances, where there are sufficient grounds to believe that taxable person will fail to make payment of any tax, penalty or interest, if the assessment is not completed immediately. Such failure to pay tax, interest or penalty must be due to reasons attributable to the tax payer (ex: insolvency, instances of defaulting, absconding etc). Hence, summary assessment under this Section is not a substitute for assessment getting time barred. Further, mere possibility of non-payment cannot be a grounds for resorting to summary assessment, unless there are factors indicating that such non-payment pertains to admitted or undisputed tax liability. As per the provision of Rule 100(3) the summary assessment order should be in **FORM GST ASMT-16**.

The section allows the person who is assessed and is served with the order so passed, to come forward and make an application in accordance with Rule 100(4) in **FORM GST ASMT-17** to the Additional / Joint Commissioner, who will examine the same and if the Additional/ Joint Commissioner is satisfied, the summary assessment order may be withdrawn. As regards the contents of this application, it may be understood that the applicant may attempt

to challenge the facts or reasons for the belief about risk of revenue loss and further accept to be available to respond, if proceedings under Section 73/74 were to be undertaken. Besides, the Additional / Joint Commissioner may, on his own motion, withdraw such order and follow the procedure laid down in Section 73 or as the case may be Section 74 for determination of taxes not paid or short paid or erroneously refunded or where input tax credit has been wrongly availed or utilised if he considers that such order is erroneous.

From the above, it appears that every summary assessment order so withdrawn under sub-Section (2), may be followed by a notice under Section 73 or as the case may be section 74 of the Act.

On receipt of application the proper officer has to pass the order of withdrawal or, rejection of the application in accordance with Rule 100(5) in **FORM GST ASMT-18**.

Many times, summary assessments are undertaken in circumstances, when a taxable person to whom liability pertains is not ascertainable. In such cases, the law provides that, if the liability pertains to supply of goods, then person in charge of such goods shall be deemed to be the taxable person liable to be assessed and pay tax and amount due on completion of summary assessment. There is no deeming provision when unpaid tax liability relates to supply of services.

64.3 Issues and Concerns

The law provides for treating the person in charge of goods as the “taxable person” in cases where the person liable to pay tax cannot be ascertained. This provision will require the transporter to take due care to ensure that his position in terms of compliance with the law will not be compromised, while several transporters may themselves be unaware of the provisions of the law.

64.4 FAQs

Q1. When can Summary Assessment be initiated?

Ans. Summary Assessments can be initiated by a proper officer on seeking permission from the Additional Commissioner / Joint Commissioner and proving that the taxable person is liable to pay tax.

64.5 MCQs

Q1. What is the time period within which a person can apply to the Additional/ Joint Commissioner for withdrawal of such order under this Section?

- (a) 30 days
- (b) 45 days
- (c) 60 days
- (d) No time limit.

Ans. (a) 30 days

Chapter 14

Audit

Sections	Rules
65. Audit by tax authorities	101. Audit
66. Special audit	102. Special Audit

Statutory provisions

<p>65. Audit by tax authorities</p> <p>(1) <i>The Commissioner or any officer authorised by him, by way of a general or a specific order, may undertake audit of any registered person for such period, at such frequency and in such manner as may be prescribed.</i></p> <p>(2) <i>The officers referred to in sub-Section (1) may conduct audit at the place of business of the registered person or in their office.</i></p> <p>(3) <i>The registered person shall be informed by way of a notice not less than fifteen working days prior to the conduct of audit in such manner as may be prescribed.</i></p> <p>(4) <i>The audit under sub-Section (1) shall be completed within a period of three months from the date of commencement of audit:</i></p> <p><i>Provided that where the Commissioner is satisfied that audit in respect of such registered person cannot be completed within three months, he may, for the reasons to be recorded in writing, extend the period by a further period not exceeding six months.</i></p> <p><i>Explanation. - For the purposes of this sub-Section, the expression 'commencement of audit' shall mean the date on which the records and other documents, called for by the tax authorities, are made available by the registered person or the actual institution of audit at the place of business, whichever is later.</i></p> <p>(5) <i>During the course of audit, the authorised officer may require the registered person,</i></p> <p>(i) <i>to afford him the necessary facility to verify the books of account or other documents as he may require;</i></p> <p>(ii) <i>to furnish such information as he may require and render assistance for timely completion of audit.</i></p> <p>(6) <i>On conclusion of audit, the proper officer shall within thirty days, inform the registered person, whose records are audited, about the findings, his rights and obligations and the reasons for such findings.</i></p>
--

- (7) *Where the audit conducted under sub-Section (1) results in detection of tax not paid or short paid or erroneously refunded, or input tax credit wrongly availed or utilised, the proper officer may initiate action under Section 73 or 74.*

Extract of the CGST Rules, 2017

101. Audit

- 1) *The period of audit to be conducted under sub-section (1) of section 65 shall be a financial year or multiples thereof.*
- 2) *Where it is decided to undertake the audit of a registered person in accordance with the provisions of section 65, the proper officer shall issue a notice in **FORM GST ADT-01** in accordance with the provisions of sub-section (3) of the said section.*
- 3) *The proper officer authorised to conduct audit of the records and the books of account of the registered person shall, with the assistance of the team of officers and officials accompanying him, verify the documents on the basis of which the books of account are maintained and the returns and statements furnished under the provisions of the Act and the rules made thereunder, the correctness of the turnover, exemptions and deductions claimed, the rate of tax applied in respect of the supply of goods or services or both, the input tax credit availed and utilised, refund claimed, and other relevant issues and record the observations in his audit notes.*
- 4) *The proper officer may inform the registered person of the discrepancies noticed, if any, as observed in the audit and the said person may file his reply and the proper officer shall finalise the findings of the audit after due consideration of the reply furnished.*
- 5) *On conclusion of the audit, the proper officer shall inform the findings of audit to the registered person in accordance with the provisions of sub-section (6) of section 65 in **FORM GST ADT-02**.*

Relevant circulars, notifications, clarifications, flyers issued by Government: NA

Related provisions of the Statute

Section or Rule	Description
Section 2(13)	<i>Definition of the term Audit</i>
Section 73	<i>Determination of tax not paid, short paid, erroneously refunded or input tax credit wrongly availed or utilized for any reason other than fraud or any wilful misstatement or suppression of facts.</i>
Section 74	<i>Determination of tax not paid, short paid, erroneously refunded or input tax credit wrongly availed or utilized by reason of fraud or any wilful misstatement or suppression of facts.</i>

65.1 Introduction

- (a) Audit of records of tax payers is the bed rock for the proper functioning of a self-assessment-based tax system. This provision provides for audit of the business transactions of any registered person. It is an important tool in the tax administration to ensure compliance of law and prevent revenue leakage.
- (b) In terms of Section 2(13) of the CGST Act, 2017, *“audit” means the examination of records, returns and other documents maintained or furnished by the registered person under this Act or the rules made thereunder or under any other law for the time being in force to verify the correctness of turnover declared, taxes paid, refund claimed and input tax credit availed, and to assess his compliance with the provisions of this Act or the rules made thereunder.*
- (c) The following three types of audits are envisaged under the GST laws:
- (i) The first type of audit is to be done by a chartered accountant or a cost accountant u/s 35(5) where turnover exceeds certain threshold specified in Rule 80(3) i.e. 2 crores;
 - (ii) Second type of audit is to be done by the commissioner or any officer authorised by him in terms of Section 65 of the CGST Act, 2017 read with Section 20(xiv) of the IGST Act, 2017 and Section 21(xv) of UTGST Act, 2017.
 - (iii) The third type of audit is called the Special Audit and is to be conducted under the mandate of Section 66 of CGST Act, 2017 read with Rule 102 of CGST Rules, 2017.

65.2 Analysis

This is probably for the first time in the history of an indirect tax statute the term audit has been defined. Audit means examination of records, returns and other documents maintained or furnished by registered person. Hence audit cannot be conducted in case of unregistered person even if he was required to be registered. In Audit records, returns and other documents to be examined, may be maintained or furnished under this Act or Rules or any other law for the time being in force. In audit examination is done to verify the correctness of 1. Turnover declared 2. Taxes Paid 3. Refund claimed and 4. Input Tax credit availed. In audit examination is also done to assess the compliance with the provisions of this Act or rules. While this chapter discusses the issues arising out of section 65 and section 66 an audit to be conducted by a chartered accountant has been dealt with elsewhere in this back ground material.

- (a) Section 65 authorizes conduct of audit by the Commissioner or any other officer authorized by him of the transactions of the registered persons only. The Commissioner may issue a general order or a specific order, to authorize officers to conduct such audit. As per Rule 101(1) the period of audit under sub-section (1) of Section 65 shall be a financial year or multiples thereof. The frequency and manner for conducting such

audit are yet to be prescribed. Normally, such issues could have been dealt with by way of issue of Office orders or circular instructions. It is important to note that the said order of Commissioner must be specific to the auditee and the tax period selected for audit. Absence, error and deficiency in such orders aborts any preparatory step taken by the audit officer and preparation to respond taken by the auditee.

The audit will be conducted at the place of business of the registered person or office of tax authorities. Intimation of audit is to be issued to the registered person at least 15 working days in advance in accordance with Rule 101(2) in **Form GST ADT-01** and the audit is to be completed within 3 months from the date of commencement of audit, which may be extended by the Commissioner, where required, by a further period not exceeding 6 months.

Commencement of Audit =		
Date on which records and other documents called for by tax authorities are made available by Registered Person	OR	Actual institution of audit at the place of business
whichever is later		

- (b) The Commissioner needs to record reasons in writing for grant of any such extension.
- (c) During the course of audit, the authorized officer may require the registered person to afford him the necessary facility to verify the books of account and also to furnish the required information and render assistance for timely completion of the audit.
- (d) As per Rule 101(4) Proper Officer may inform discrepancies noticed during audit to registered person. Registered Person shall reply to discrepancies. Proper Officer shall finalize findings only after due consideration of reply
- (e) Some of the best practices to be adopted for GST audit among others could be:
The evaluation of the internal control *viz-a-viz* GST would indicate the area to be focused. This could be done by verifying:
 - (a) The Statutory Audit report which has specific disclosure needs in regard to maintenance of record, stock and fixed assets.
 - (b) The Information System Audit report and the internal audit report.
 - (c) Internal Control questionnaire designed for GST compliance.
 - (i) The use of generalised audit software to aid the GST audit would ensure modern practice of risk-based audit are adopted.
 - (ii) The reconciliation of the books of account or reports from the ERP's to the return is imperative.
 - (iii) The review of the gross trial balance for detecting any incomes being set off with expenses.

- (iv) Review of purchases/expenses to examine applicability of reverse charge applicable to goods/services. The foreign exchange outgo reconciliation would also be necessary for identifying the liability of import of services.
 - (v) Quantitative reconciliation of stock transfer within the State or for supplies to job workers under exemption.
 - (vi) Ratio analysis could provide vital clues on areas of non-compliance.
- (f) On audit completion, information is required to be provided to the registered person including the findings during the audit as per section 65(6) read with Rule 101(5) in **FORM GST ADT-02** within thirty days (not mentioned I s. 65(6)). In cases where tax liability is identified during the audit or input tax credit wrongly availed or utilized by the auditee, the procedure laid down under Section 73 or 74 is to be followed. Audit cannot conclude automatically resulting in a demand. Independent application of mind is necessary for a valid demand to be raised.

65.3 Comparative Review

1. The Central Excise law empowers the Central Government to make provision for verification of records of assessee. However, the GST Act itself specifically provides for audit of the registered person. In EA 2000, the Director General of Audit supervises the audit functions. Separate Audit Commissionerate have been constituted with effect from 15.10.2014 which will plan, delegate and administer the audit. The audit of the assessee is carried out through visits by 'audit groups' which consist of Superintendents and Inspectors.
2. The audit groups shall prepare the assessee master file, collect the relevant information and documents. Desk review shall be done before forming the audit plan. As planned, audit will be conducted and corrections and improvements shall be suggested to the assessee.
3. The draft audit report would be discussed and communicated to the assessee and with the details of spot recoveries and willingness of the assessee to accept the demand etc. the same shall be placed before monitoring committee. If the assessee does not accept the audit para, adjudication process will be initiated by the Jurisdictional GST Officer.

65.4 FAQs

- Q1. Whether audit is mandatory in case of every registered person?
- Ans. No, it is not mandatory. It will be applicable only in cases where the appropriate authorities authorize the same by issue of general / specific orders.
- Q2. Whether any prior intimation is required before conducting the audit?
- Ans. Yes, prior intimation is required and the taxable person should be informed at least 15 days prior to conduct of audit in FORM GST ADT-01.
- Q3. What is the period within which the audit is to be completed?

Ans. The audit is required to be completed within 3 months from the date of commencement of audit or within the extended period of 6 months in cases where the Commissioner is satisfied for reasons to be recorded in writing that the audit cannot be completed in 3 months.

Q4. What is meant by commencement of audit?

Ans. It means the date on which the records and documents requisitioned by the tax authorities are made available by the registered person or the actual institution of audit at the place of business whichever is later

Q5. What are the obligations of the taxable person when he receives the notice of audit?

Ans. The taxable person should afford necessary facility / information / assistance / documents for smooth conduct of audit and its timely completion.

Q6. What would be the action by the proper officer upon conclusion of the audit?

Ans. The proper office must within 30 days inform the registered person (i.e. the auditee) about his findings, reasons for findings and his rights and obligations in respect of such findings.

65.5 Case Study 1

A notice for audit was served to M/s. ABC Ltd, on 20.02.2020. Required information was given by M/s. ABC Ltd, on 25.05.2020. The audit officers visited the place of business on 26.06.2020. What is the last date within which the audit is to be completed?

It will be 3 months from 26.06.2020, viz., 25.09.2020 or within an extended period of 6 months. The extended period would be 25.03.2021.

Statutory provisions

66. Special Audit

- (1) *If at any stage of scrutiny, enquiry, investigation or any other proceedings before him, any officer not below the rank of Assistant Commissioner, having regard to the nature and complexity of the case and interest of revenue, is of the opinion that the value has not been correctly declared or the credit availed is not within the normal limits, he may, with the prior approval of the Commissioner, direct such registered person by a communication in writing to get his records including books of account examined and audited by a chartered accountant or a cost accountant as may be nominated by the Commissioner.*
- (2) *The chartered accountant or cost accountant so nominated shall, within the period of ninety days, submit a report of such audit duly signed and certified by him to the said Assistant Commissioner mentioning therein such other particulars as may be specified:*

Provided that the Assistant Commissioner may, on an application made to him in this behalf by the registered person or the chartered accountant or cost accountant or for any material and sufficient reason, extend the said period by a further period of ninety days.

- (3) *The provision of sub-Section (1) shall have effect notwithstanding that the accounts of the registered person have been audited under any other provision of this Act or any other law for the time being in force.*
- (4) *The registered person shall be given an opportunity of being heard in respect of any material gathered on the basis of special audit under sub-Section (1) which is proposed to be used in any proceedings against him under this Act or the rules made thereunder.*
- (5) *The expenses of the examination and audit of records under sub-Section (1), including the remuneration of such chartered accountant or cost accountant, shall be determined and paid by the Commissioner and such determination shall be final.*
- (6) *Where the special audit conducted under sub-Section (1) results in detection of tax not paid or short paid or erroneously refunded, or input tax credit wrongly availed or utilised, the proper officer may initiate action under Section 73 or 74.*

Extract of the CGST Rules, 2017

102. Special Audit.

- 1) Where special audit is required to be conducted in accordance with the provisions of section 66, the officer referred to in the said section shall issue a direction in FORM GST ADT-03 to the registered person to get his records audited by a chartered accountant or a cost accountant specified in the said direction.
- 2) On conclusion of the special audit, the registered person shall be informed of the findings of the special audit in FORM GST ADT-04.

Relevant circulars, notifications, clarifications, flyers issued by Government: NA

Related provisions of the Statute

Section or Rule	Description
Section 65	Audit by tax authorities
Section 73	Determination of tax not paid, short paid, erroneously refunded or input tax credit wrongly availed or utilized for any reason other than fraud or any wilful misstatement or suppression of facts.
Section 74	Determination of tax not paid, short paid, erroneously refunded or input tax credit wrongly availed or utilized by reason of fraud or any wilful misstatement or suppression of facts.

66.1 Introduction

Availing the services of experts is an age-old practice and a due process of law. These experts have done yeoman service to the process of delivering justice. One such facility extended by the Act is in Section 66 where an officer not below the rank of an Assistant Commissioner, duly approved, may avail the services of a Chartered Accountant or Cost Accountant to conduct a detailed examination of specific areas of operations of a registered person. Similar provisions exist under the Income Tax Law as well.

66.2 Analysis

- (a) Availing the services of the expert be it a Chartered Accountant or Cost Accountant is permitted by this section only when the officer (considering the nature & complexity of the business and in the interest of revenue) is of the opinion that:

- Value has not been correctly declared; or
- Credit availed is not within the normal limits.

It would be interesting to know how these 'subjective' conclusions will be drawn and how the proper officers determine what is the normal limit of input credit availed.

- (b) An Assistant Commissioner who nurses an opinion on the above two aspects, after commencement and before completion of any scrutiny, enquiry, investigation or any other proceedings under the Act, may direct a registered person to get his books of accounts audited by an expert. Such direction is to be issued in accordance with the provision of Rule 102 (1) **FORM GST ADT-03**
- (c) The Assistant Commissioner needs to obtain prior permission of the Commissioner to issue such direction to the taxable person
- (d) Identifying that the expert is not left to be appointed by the registered person whose audit is to be conducted but the expert is to be nominated by the Commissioner.
- (e) The Chartered Accountant or the Cost Accountant so appointed shall submit the audit report, mentioning the specified particulars therein, within a period of 90 days, to the Assistant Commissioner in accordance with provision of Rule 102(2) **FORM GST ADT-04**.
- (f) In the event of an application to the Assistant Commissioner by Chartered Accountant or the Cost Accountant or the registered person seeking an extension, or for any material or sufficient reason, the due date of submission of audit report may be extended by another 90 days.
- (g) Section 66(3) states that special audit may be initiated notwithstanding that the accounts of the registered person have been audited under any other provisions of this Act or any other law for the time being in force. While the report in respect of the special audit under this section is to be submitted directly to the Assistant Commissioner, the registered person is to be provided an opportunity of being heard in respect of any

material gathered in the special audit which is proposed to be used in any proceedings under this Act. This provision does not appear to clearly state whether the registered person is entitled to receive a copy of the entire audit report or only extracts or merely inferences from the audit. However, the observance of the principles of natural justice in the proceedings arising from this audit would not fail the taxable person on this aspect.

- (h) The remuneration to the expert is to be determined and paid by the Commissioner whose decision will be final.
- (i) As in the case of audit under section 65, no demand of tax, even *ad interim*, is permitted on completion of the special audit under this section. In case any possible tax liability is identified during the audit, procedure under section 73 or 74 as the case may be is to be followed.

66.3 Comparative Review

Law relating to Central Excise

- (a) Similar provision existed under the Central Excise law. Unduly large proportion of credit availment considering the industry is a reason for audit. This could also be a reason for special audit under GST also. The availing or utilization of CENVAT credit by reason of fraud, collusion or any willful mis-statement or suppression of facts can also be the reason for issuing notice for special audit. Under GST law, no special audit will be directed for wrong utilization of the credit, but wrong availment alone without any reason of fraud, collusion or any willful mis-statement or suppression of facts is sufficient to issue notice for special audit.
- (b) Under Central Excise law, the permission is given by the Principal Chief Commissioner or the Chief Commissioner of Central Excise. Under GST Act, the said permission is to be given by the Commissioner.
- (c) Under Central Excise law, the period within which the Chartered Accountant or the Cost Accountant should submit the audit report is not specified but the maximum extended period within which the audit report should be submitted remains to be 180 days. Under CGST Act, the audit report shall normally be submitted within 90 days and the maximum further extension could be another 90 days.

Law relating to Service Tax

- (a) The authority to direct the special audit rests with the Principal Commissioner or the Commissioner.
- (b) The special audit may be initiated where person liable to pay service tax;
 - (i) has failed to declare or determine the value of taxable service correctly; or
 - (ii) has availed and utilized the CENVAT credit which is not within the normal limits or by means of fraud, collusion or any willful mis-statement or suppression of facts; or

- (iii) has operations at multiple locations and true and complete picture of his accounts are not possible to get at his registered premises.
- (c) The special audit report shall be submitted within the period as may be specified by the Commissioner. The time limit of maximum 180 days is not applicable.
- (d) No provision exists regarding remuneration payable for the special audit, however, the same shall be paid by the Central Government

66.4 FAQs

Q1. Who can serve the notice for special audit?

Ans. An officer not below the rank of an Assistant Commissioner with prior approval of the Commissioner may serve notice for special audit, having regard to the nature and complexity of the case and the interest of revenue.

Q2. Under what circumstances notice for special audit shall be issued?

Ans. If the proper officer (not below the rank of Assistant Commissioner) is of the opinion that the value has not been correctly declared or credit availed is not within the normal limits, a special audit may be ordered.

Q3. Who will conduct the special audit?

Ans. A Chartered Accountant or a Cost Accountant as may be nominated by the Commissioner may undertake the audit.

Q4. What is the time limit to submit the audit report?

Ans. The auditor will have to submit the report within 90 days or the further extended period of 90 days.

Q5. Who will bear the cost of special audit?

Ans. The expenses for examination and audit including the remuneration payable to the auditor will be determined and borne by the Commissioner.

Q6. What action the tax authorities may take after the special audit?

Ans. Based on the findings / observations of the special audit, action can be initiated under Section 73 or 74 as the case may be of the CGST Act.

THE INTEGRATED GOODS AND SERVICE TAX ACT, 2017

Statement of Objects and Reasons:

Earlier, the States effecting inter-State sale of goods were empowered to collect and retain Central Sales Tax (CST) under the Central Sales Tax Act, 1956.

The difficulties faced in the erstwhile Central Sales Tax system are:

- (i) The levy is non-vatable i.e. the credit of CST is not available as a set-off in the hands of the purchaser.
- (ii) CST directly gets added to the cost of the goods resulting in cascading effect of the taxes on the cost of production of products.
- (iii) Creation of tax arbitrage on account of the rate of CST being different from VAT levied on intra-State sale.
- (iv) Several businesses are not in a position to procure goods in the course of inter-State trade or commerce after concessional rate of tax against the declaration forms.

To usher in the GST regime, levy of a single tax called Integrated Goods and Service Tax is considered necessary on the supply of goods or services or both taking place in the course of inter-State trade/ commerce. The rate of tax is equal to the sum total of Central Tax (CGST) and State Tax (SGST) or Union Territory Tax (UTGST) though there are some cases where more rationalisation is required in terms of parity of net tax incidence. The new legislation, amongst others, broadly:

- (i) Provides for levy of tax on all inter-State supplies of goods or services or both (except alcoholic liquor for human consumption) at a rate recommended by the GST Council (not exceeding 40%);
- (ii) Provides for levy of tax on goods imported into India;
- (iii) Provides for levy of tax on import of services on a reverse charge basis;
- (iv) Empowers the Central Government to grant exemptions on the recommendation of the GST Council;
- (v) Provides for determination of nature of supply (intra-State or inter-State) and place of supply
- (vi) Provides for payment of tax by a supplier of Online Information and Database Access or Retrieval Services (OIDAR)
- (vii) Enables apportionment of tax and settlement of funds on account of transfer of input tax credit between the Central Government, State Government and Union Territory; `
- (viii) Provides for application of certain provisions of the Central Goods and Service Tax Act, 2017 to the extent relevant for the purposes of this Act;
- (ix) Provides for transitional transactions in relation to import of services.

Chapter I

Preliminary

1. Short title, extent and commencement
2. Definitions

Statutory Provisions

1. Short title, extent and commencement

- (1) This Act may be called the Integrated Goods and Services Tax Act, 2017.
- (2) It shall extend to the whole of India except the State of Jammu & Kashmir.
- (3) It shall come into force on such date as the Central Government may, by notification in the Official Gazette, appoint:

Provided that different dates may be appointed for different provisions of this Act and any reference in any such provision to the commencement of this Act shall be construed as a reference to the coming into force of that provision.

1. The Central Goods and Services Tax Act, 2017 has been implemented in the State of Jammu and Kashmir from 8th July 2017 through Constitution (Application to Jammu and Kashmir) Amendment Order, 2017, the Central Goods and Services Tax (Extension to Jammu and Kashmir) Ordinance, 2017 and the Integrated Goods and Services Tax (Extension to Jammu and Kashmir) Ordinance, 2017.
2. Certain provisions came into force on 22.6.17 and remaining provisions on 1.7.17 as notified by the Central Government and hence appointed day for the CGST Act, IGST, UTGST Acts, SGST Acts was 1st July 2017. However, the appointed day for the State of Jammu and Kashmir was 8th July 2017.

Section or Rule (CGST / SGST)	Description
Section 2(56)	Definition of India
Section 2(22)	Definition of Taxable Territory

Relevant circulars, notifications, clarifications issued by Government

1. Notification No. 01/2017 – Central Tax dated 19.06.2017 Seeks to appoint 22.06.2017 as the date on which the provisions of Section 1, 2, 3, 14, 20 and 22 are effective.
2. Notification No. 03/2017 – Central Tax dated 28.06.2017 Seeks to appoint 01.07.2017 as the date on which the provisions of Section 4 to 13, 16 to 19, 21, 23 to 25 are effective.

Title

All Acts enacted by the Parliament since the introduction of the Indian Short Titles Act, 1897 carry a long and a short title. The *long title*, set out at the head of a statute, gives a full description of the general purpose of the Act and broadly covers the scope of the Act.

The *short title*, serves simply as an ease of reference and is considered a statutory nickname to obviate the necessity of referring to the Act under its full and descriptive title. Its object is identification, and not description, of the purpose of the Act.

Extent

Part I of the Constitution of India states: "India, that is Bharat, shall be a Union of States". It provides that territory of India shall comprise the States and the Union Territories specified in the First Schedule of the Constitution of India. The First Schedule provides for twenty-nine (29) States and seven (7) Union Territories.

Part VI of the Constitution of India provides that for every State, there shall be a Legislature, while Part VIII provides that every Union Territory shall be administered by the President through an 'Administrator' appointed by him. However, the Union Territories of Delhi (Article 239 AA) and Pondicherry (Article 239A) have been provided with Legislatures with powers and functions as required for their administration.

India is a summation of three categories of territories namely – (i) States (29); (ii) Union Territories with Legislature (2); and (iii) Union Territories without Legislature (5).

The State of Jammu and Kashmir enjoys a special status in the Indian Constitution in terms of Article 370 of the Indian Constitution. The Parliament has power to make laws only on Defence, External Affairs and Communication related matters of Jammu and Kashmir. As regards the laws related on any other matter, subsequent ratification by the Government of Jammu and Kashmir is necessary to make it applicable to that State.

The assembly of J&K had passed the GST bill in the first week of July. Subsequently, the Honourable President of India promulgated two ordinances, namely, the CGST (Extension to Jammu and Kashmir) Ordinance, 2017 and the IGST (Extension to Jammu and Kashmir) Ordinance, 2017 making the CGST/ IGST applicable to the State of Jammu and Kashmir, w.e.f. 8 July 2017. After the promulgation of ordinance, India has adopted GST in its form across the country.

Commencement

Provisions of the IGST Act related to registration etc. came into operation through Notification No. 1/2017- Integrated Tax dated 19.6.2017. Further, Notification No. 3/2017-Integrated Tax was issued to make other provisions of the IGST Act applicable w.e.f. 1st July. Effectively, all operation provisions of the IGST Act have become applicable from 1st July 2017.

Similar to extending enforcement of IGST Act, Notification No. 4/ 2017–Integrated Tax dated 28th June, 2017 has been issued to make Integrated Goods and Services Tax Rules,

2017 applicable w.e.f. 22nd June 2017. However, IGST Rules, 2017 have been separately notified along with the Central Goods and Services tax Rules, 2017.

Statutory Provisions

2. Definitions

In this Act, unless the context otherwise requires-

(1) *“Central Goods and Services Tax Act” means the Central Goods and Services Tax Act, 2017;*

It refers to the Act under which tax is levied on intra-State supply of goods or services or both (other than supply of alcoholic liquor for human consumption).

(2) *“central tax” means the tax levied and collected under the Central Goods and Services Tax Act;*

Tax levied under the CGST Act is referred to as “Central tax”. It refers to the tax charged under the CGST Act on intra-State supply of goods or services or both (other than supply of alcoholic liquor for human consumption). The rate of tax is capped at 20%. The rates for goods have been notified vide Notification No. 1/2017- Integrated Tax (Rate) dated 28-06-2017 while Notification No. 8/2017- Integrated Tax (Rate) dated 28-06-2017 covers the rates of services notified.

It is relevant to note that the term ‘central tax’ under the IGST Act is defined to include tax levied and collected under the CGST Act whereas the term ‘central tax’ under the CGST Act is defined to mean the central goods and services levied under section 9. Therefore, the phrase ‘central tax’ has a wider connotation under the IGST Act as it includes taxes collected in addition to what is levied under CGST Act.

(3) *“continuous journey” means a journey for which a single or more than one ticket or invoice is issued at the same time, either by a single supplier of service or through an agent acting on behalf of more than one supplier of service, and which involves no stopover between any of the legs of the journey for which one or more separate tickets or invoices are issued.*

Explanation. —For the purposes of this clause, the term “stopover” means a place where a passenger can disembark either to transfer to another conveyance or break his journey for a certain period in order to resume it at a later point of time;

This is relevant to determine the place of supply of passenger transport services.

Continuous journey refers to a journey where:

- (a) A single or more than one ticket or invoice is issued at the same time;
- (b) Service is provided by one service provider or by an agent on behalf of more than one service providers
- (c) Journey does not involve any stopover at any of the legs of the journey for which one or

more separate tickets or invoices are issued (“Stopover” means a place where a passenger disembarks from the conveyance).

The following aspects need to be noted:

- All stopovers will not cause a break in the journey. Only those stopovers for which one or more separate tickets are issued will be relevant. A travel involving Bangalore-Dubai-New York-Dubai-Bangalore on a single ticket with a halt at Dubai (onward and return) will be covered by the definition of continuous journey. However, if the passenger disembarks at Dubai or breaks his journey for a certain period in order to resume it at a later point of time, it will not be considered a continuous journey.
- All the above conditions should be cumulatively satisfied to consider the journey as continuous journey.
- A return journey will be treated as a separate journey even if the right to passage for onward and return journey is issued at the same time.

(4) “customs frontiers of India” means the limits of a customs area as defined in section 2 of the Customs Act, 1962;

Circular No. 33/2017 –Cus dated 01.08.2017: Leviability of Integrated Goods and Services Tax (IGST) on High Sea Sales of imported goods and point of collection thereof

The customs frontiers of India include the following:

- (a) Customs Port;
- (b) Customs Airport;
- (c) International Courier Terminal;
- (d) Foreign Post Office;
- (e) Land Customs Station;
- (f) Area in which imported goods or goods meant for export are ordinarily kept before clearance by Customs Authorities

The following aspects need to be noted:

- Bonded Warehouses would now be covered under this definition.
- A person importing goods into the territory of India from an overseas exporter would be liable to pay IGST on such supply of goods.
- Where a transfer of documents of title takes place during import, the question of payment of tax by the importer would not arise since the documents of title would be transferred before the goods cross the customs frontier of India. It has been clarified vide *Circular No. 33 /2017-Cus dated 1-Aug-17*, that IGST on high sea sale(s) transactions of imported goods, whether one or multiple, shall be levied and collected

only at the time of importation i.e. when the import declarations are filed before the Customs authorities for the customs clearance purposes for the first time.

- Supplies made by an importer after the goods have crossed the customs frontier of India would be liable to CGST, SGST or IGST, depending on the facts of each case.

(5) "export of goods" with its grammatical variations and cognate expressions, means taking goods out of India to a place outside India;

Section or Rule	Description
Section 2(52)	Definition of Goods (CGST)
Section 2(56)	Definition of India (CGST)
Section 7	Inter-State supply (IGST)
Section 11	Place of supply of goods imported into or exported from India
Section 16	Zero rated supply

Export of goods will be treated as 'zero-rated supplies'. Accordingly, while no tax would be payable on such supplies, the exporter will be eligible to claim the corresponding input tax credits. It is relevant to note that the input tax credits would be available to an exporter even if the supplies were exempt supplies so long as the eligibility of the input taxes is established.

Following aspects need to be noted:

- Unlike export of services which requires fulfilment of certain conditions for a supply to qualify as 'export of services' like the nature of currency in which payment is required to be made, location of the exporter etc., export of goods doesn't require fulfilment of any such conditions.
- The movement of goods is alone relevant and not the location of the exporter/ importer.
- The exporter may utilize such credits for discharge of other output taxes or alternatively, the exporter may claim a refund of such taxes.
- The exporter will be eligible to claim refund under the following situations:
 - (i) He may export the goods under a Letter of Undertaking, without payment of IGST and claim refund of unutilized input tax credit; or
 - (ii) He may export the goods upon payment of IGST and claim refund of such tax paid.

(6) "export of services" means the supply of any service when, —

- (i) the supplier of service is located in India;
- (ii) the recipient of service is located outside India;
- (iii) the place of supply of service is outside India;

- (iv) *the payment for such service has been received by the supplier of service in convertible foreign exchange or in Indian rupees wherever permitted by the Reserve Bank of India*¹; and
- (v) *the supplier of service and the recipient of service are not merely establishments of a distinct person in accordance with Explanation 1 in section 8;*

Section or Rule	Description
Section 2(52)	Definition of Goods (CGST)
Section 2(56)	Definition of India (CGST)
Section 2(93)	Definition of Recipient (CGST)
Section 2(105)	Definition of Supplier (CGST)
Section 2(14)	Definition of Location of the recipient of services
Section 2(14)	Definition of Location of the supplier of services
Section 2(21)	Definition of Supply
Section 7	Inter-State supply
Section 8	Intra-State supply
Section 10	Place of supply of goods other than supply of goods imported into, or exported from India
Section 12	Place of supply of services where location of supplier and recipient is in India
Section 13	Place of supply of services where location of supplier or location of recipient is outside India
Section 16	Zero rated supply

The concept of export of services is broadly borrowed from the provisions of the erstwhile Service Tax law.

Under the GST regime, export of service will be treated as 'zero-rated supplies'. Accordingly, while no tax would be payable on such supplies, the exporter will be eligible to claim the corresponding input tax credits. It is relevant to note that the input tax credits would be available to an exporter even if supplies were exempt supplies as long as the eligibility of the input taxes as input tax credits is established.

The exporter may utilise such credits for discharge of other output taxes or alternatively, the exporter may claim a refund of such taxes.

¹ Inserted vide *The Integrated Goods and Services Tax (Amendment) Act, 2018 w.e.f. 01.02.2019*

The exporter will be eligible to claim refund under the following situations:

- (a) He may export the services under a Letter of Undertaking, without payment of IGST and claim refund of unutilized input tax credit; or
- (b) He may export the services upon payment of IGST and claim refund of such tax paid.

The following aspects need to be noted:

- The requirement under the Service Tax law was that the supplier should be located in the taxable territory i.e. India, excluding Jammu and Kashmir. Under the GST law, the requirement is that the supplier is located in India (which includes Jammu and Kashmir) as GST has been enacted in the State of J&K also.
- Although overseas establishment of a person who is situated in India is treated as a distinct person for purposes of levy of integrated tax, as regards export of services, this overseas establishment must demonstrate substance in its activities to qualify as recipient of the export of the services from India and establish itself as more than just a mere establishment of the person.
- Establishments will be treated as establishment of distinct persons under the following situations:

Situation	Location of one establishment	Location of the other establishment
I	India	Outside India
II	State or Union Territory	Outside that State or Union Territory
III	State or Union Territory	Business vertical registered in that State or Union Territory

Therefore, where both the establishments are located in a State/ Union Territory under the same GSTIN, the establishments will not be considered as distinct persons.

IGST Amendment Act, 2018

In clause (6), in sub-clause (iv), after the words "foreign exchange", the words "or in Indian rupees wherever permitted by the Reserve Bank of India" inserted. This amendment is made to consider a service to be exported even if the export proceeds are received in Indian rupees, if the same is permitted by RBI.

(7) "fixed establishment" means a place (other than the registered place of business) which is characterised by a sufficient degree of permanence and suitable structure in terms of human and technical resources to supply services or to receive and use services for its own needs;

Section or Rule	Description
Section 2(85)	Definition of Place of Business (CGST)
Section 2(102)	Definition of Services (CGST)
Section 12	Place of supply of services where location of supplier and recipient is in India
Section 13	Place of supply of services where location of supplier or location of recipient is outside India

Fixed Establishment refers to a place:

- (a) Having a sufficient degree of permanence
- (b) Having a structure of human and technical resources
- (c) Other than the registered place of business

The following aspects need to be noted:

- Not every temporary or interim location of a project site or transit-warehouse will (*ipso facto*) become a fixed establishment of the taxable person.
- The person should undertake supply of services or should receive and use services for own needs.
- Temporary presence of staff in a place by way of a short visit to a place or so does not make that place a fixed establishment.
- Liaison Offices meant to undertake liaison activities cannot render services that are commercial in nature, in the garb of rendering liaison services. For e.g.: If a liaison office were to render marketing service to its parent entity outside India, for a customer located in India and the said liaison office staff receive a fee/ commission, then the concept of liaison office stands to test. In such a scenario, the reimbursements received by the liaison office could be subject to tax notwithstanding the fact that the entire transaction can be subjected to valuation as a permanent establishment.

However TAMILNADU ADVANCE RULING AUTHORITY in case of M/s TAKKO HOLDING GMBH (2018-TIOL-216-AAR-GST) The key issue brought before the AAR was whether reimbursement of expenses and salary paid by overseas counterpart to liaison office qualify as supply and thereby necessitates liaison office to obtain GST registration and discharge GST liability. The AAR denied the necessity of obtaining registration as well as payment of GST. The decision was based on the findings that Applicant is neither a 'related persons' nor 'distinct persons' but is acting only as an extension of the German Office. The authorities also noted that Applicant is only working as an employee of foreign entity and thus cannot be treated as a 'supplier' thereof.

(8) *“Goods and Services Tax (Compensation to States) Act” means the Goods and Services Tax (Compensation to States) Act, 2017;*

Section or Rule	Description
Section 2(54)	Definition of Goods and Services Tax (Compensation to States) Act

The Goods and Services Tax (Compensation to States) Act (for brevity “Compensation Act”) provides for compensation to the States for the loss of revenue arising on account of implementation of GST for a period of 5 years from the said date of implementation. The cess paid on the supply of goods or services will be available as credit for utilization towards payment of said cess on outward supply of goods and services on which such cess is leviable.

(9) *“Government” means the Central Government;*

(10) *“import of goods” with its grammatical variations and cognate expressions, means bringing goods into India from a place outside India;*

Section or Rule	Description
Section 2(52)	Definition of Goods (CGST)
Section 2(56)	Definition of India (CGST)
Section 7	Inter-State supply
Section 8	Intra-State supply
Section 11	Place of supply of goods imported into or exported from India

Import of goods into India would be treated as supply of goods in the course of inter-State trade/ commerce and would be liable to integrated tax under this Act.

The following aspects need to be noted:

- The place of supply of goods in case of imports would be the location of the importer. E.g.: If goods are imported at Mumbai port but the importer is at Delhi, the place of supply shall be Delhi;
- The integrated tax would be levied on the value of goods as determined under the Customs law in addition to the custom duties levied on such imports. In other words, levy of Basic Customs Duty (BCD) will continue and the component of Countervailing Duty (CVD) and Special Additional Duty (SAD) will be replaced by Integrated tax;
- The time at which the customs duties are levied on import of goods would also be the time when integrated tax is levied;

- The importer will be liable to pay integrated tax on a reverse charge basis and the same will have to be discharged by cash only and credit cannot be utilized for discharging such a liability;
- Merchant Trading Transactions (MTT) i.e. where the supplier of goods will be resident in one foreign country, the buyer of goods will be resident in another foreign country and the merchant will be resident in India, would primarily not come under the ambit of GST since they do not involve entry of goods into India.

In case of multi State registration, GSTIN mentioned on the Bill of entry would discharge the IGST on Reverse charge on import of goods even if the port is situated in separate State

(11) "import of services" means the supply of any service, where—

- (i) the supplier of service is located outside India;
- (ii) the recipient of service is located in India; and
- (iii) the place of supply of service is in India;

Section or Rule	Description
Section 2(56)	Definition of India (CGST)
Section 2(86)	Definition of Place of supply (CGST)
Section 2(93)	Definition of Recipient (CGST)
Section 2(105)	Definition of Supplier (CGST)
Section 2(14)	Definition of Location of the recipient of services (IGST)
Section 2(21)	Definition of Supply (IGST)
Section 7	Inter-State supply (IGST)
Section 16	Zero rated supply

The phrase "import of service" is very broad and covers all such supplies where:

- (a) The supplier is located outside India,
- (b) The recipient is located in India
- (c) Place of supply is in India.

The following aspects need to be noted:

- Supplies, where the supplier and recipient are mere establishments of a person, would also qualify as "import of service".
- The importer will be liable to pay integrated tax on a reverse charge basis and the same will have to be discharged by cash only and credit cannot be utilized for discharging such a liability;

- Import of service made for a consideration alone would be taxable, whether or not in the course of business. Therefore, import of service for personal consumption for a consideration would qualify as 'supply' and would be liable to integrated tax. However, the recipient will not be required to obtain a registration for that purpose. However, Import of services from related persons or establishments located outside India without consideration also would be liable to integrated tax as per Schedule I of the CGST Act, 2017;
- The threshold limits for registration would not apply and the importer would be required to obtain registration irrespective of his turnover.

(12) "integrated tax" means the integrated goods and services tax levied under this Act;

Section or Rule	Description
Section 2(52)	Definition of Goods (CGST)
Section 2(102)	Definition of Services (CGST)
Section 7	Inter-State supply

It refers to the tax charged under this Act on inter-State supply of goods or services or both (other than supply of alcoholic liquor for human consumption). The rate of tax is capped at 40%. The rates for goods have been notified vide Notification No. 1/2017- Integrated Tax (Rate) dated 28-06-2017 while Notification No. 8/2017- Integrated Tax (Rate) dated 28-06-2017 covers the rates of services notified.

(13) "intermediary" means a broker, an agent or any other person, by whatever name called, who arranges or facilitates the supply of goods or services or both, or securities, between two or more persons, but does not include a person who supplies such goods or services or both or securities on his own account;

Section or Rule	Description
Section 13	Place of supply of services where location of supplier or location of recipient is outside India
Section 14	Special provision for payment of tax by a supplier of online information and database access or retrieval services

The following aspects need to be noted:

- An intermediary arranges or facilitates supply of goods or services or both, or securities between two or more persons. For e.g.: Travel Agent
- Two supplies are generally involved:
 - Supply between the principal and the third party; and
 - Supply of his own service to his principal – generally for a fee or commission;

- An intermediary cannot alter the nature or value of supply, which he facilitates on behalf of his principal;
- The consideration for an intermediary's supply is separately identifiable from the main supply that he is arranging and is in the nature of fee or commission charged by him;
- The test of agency must be satisfied between the principal and the agent i.e. the intermediary;
- The place of supply in relation to intermediary services is the location of the service provider.

(14) "location of the recipient of services" means, —

- (a) where a supply is received at a place of business for which the registration has been obtained, the location of such place of business;
- (b) where a supply is received at a place other than the place of business for which registration has been obtained (a fixed establishment elsewhere), the location of such fixed establishment;
- (c) where a supply is received at more than one establishment, whether the place of business or fixed establishment, the location of the establishment most directly concerned with the receipt of the supply; and
- (d) in absence of such places, the location of the usual place of residence of the recipient;

The phrase 'location of the recipient of services' is essential to determine the place of supply of service and can be understood in the following 4 sub-clauses:

- (a) Services received at a place of business where registration is obtained – Location of such place of business;
- (b) Services received at a fixed establishment (i.e., a place of business not registered, but having a sufficient degree of permanence involving human and technical resources) – Location of such fixed establishment;
- (c) Services received at more than one establishment – Location of the establishment most directly concerned with the receipt of the supply;
- (d) Services received at a place other than above – Location of the usual place of residence of the recipient (address where the person is legally registered/ constituted in case of recipients other than individuals).

Note: The definition uses the term "place", and not the phrase "State or Union Territory". Therefore, a view may be taken that the location of the recipient of the service could be determined under the residuary clause (i.e., usual place of residence), merely because it is received in a place of business which is neither registered as an additional place of business, nor a fixed establishment, although the place of receipt is in the same State as another place of business which is registered.

E.g.: Event management services received in the Mangalore unit of M/s. ABC Ltd. M/s. ABC Ltd has its registered office in Mumbai (having a GST registration) and has a branch office in Bangalore (having a GST registration). Mangalore unit is neither an additional place of business nor a fixed establishment. In such a case, a view may be taken that the location of the recipient of service is the Mumbai office, and not the Bangalore office, although Bangalore and Mangalore are located in the same State.

- (15) "location of the supplier of services" means, —
- (a) where a supply is made from a place of business for which the registration has been obtained, the location of such place of business;
 - (b) where a supply is made from a place other than the place of business for which registration has been obtained (a fixed establishment elsewhere), the location of such fixed establishment;
 - (c) where a supply is made from more than one establishment, whether the place of business or fixed establishment, the location of the establishment most directly concerned with the provision of the supply; and
 - (d) in absence of such places, the location of the usual place of residence of the supplier;

The phrase 'location of the supplier of services' is essential to determine the place of supply of service and can be understood in the following 4 sub-clauses:

- (a) Services made from a place of business where registration is obtained – Location of such place of business;
- (b) Services made from a fixed establishment (i.e., a place of business not registered, but having a sufficient degree of permanence involving human and technical resources) – Location of such fixed establishment;
- (c) Services made from more than one establishment – Location of the establishment most directly concerned with the receipt of the supply;
- (d) Other than the above – Location of the usual place of residence of the supplier (address where the person is legally registered/ constituted in case of recipients other than individuals).

Note: The definition uses the term "place", and not the phrase "State or Union Territory". Therefore, a view may be taken that the location of the provider of the service could be determined under the residuary clause (i.e., usual place of residence), merely because it is provided from a place of business which is neither registered as an additional place of business, nor a fixed establishment, although the place of provision is in the same State as another place of business which is registered.

Where services are provided from more than one establishment i.e. principal place of business and fixed establishment, the location of the establishment with which the service receiver is directly concerned will be considered for the purpose of determining the location of supply.

(16) “non-taxable online recipient” means any Government, local authority, governmental authority, an individual or any other person not registered and receiving online information and database access or retrieval services in relation to any purpose other than commerce, industry or any other business or profession, located in taxable territory.

Explanation. —For the purposes of this clause, the expression “governmental authority” means an authority or a board or any other body, —

(i) set up by an Act of Parliament or a State Legislature; or

(ii) established by any Government,

with ninety per cent. or more participation by way of equity or control, to carry out any function entrusted to a **Panchayat under article 243G** or ²a municipality under article 243W of the Constitution;

Notification No. 02/2017 dated 19.06.2017 - Seeks to empower the Principal Commissioner of Central Tax, Bengaluru West to grant registration in case of online information and database access or retrieval services provided or agreed to be provided by a person located in non-taxable territory and received by a non-taxable online recipient

The phrase “non-taxable online recipient” covers the following persons:

- (a) The Central Government
- (b) Local Authority
- (c) Governmental Authority i.e. an authority established with 90% or more participation by the Government and set-up to undertake functions entrusted to a municipality under Article 243W of the Constitution like:
 - Preparation of plans for economic development,
 - Urban planning,
 - Fire Services,
 - Water supply, etc.

(17) “online information and database access or retrieval services” means services whose delivery is mediated by information technology over the internet or an electronic network and the nature of which renders their supply essentially automated and involving minimal human intervention and impossible to ensure in the absence of information technology and includes electronic services such as, —

(i) advertising on the internet;

(ii) providing cloud services;

² Inserted vide *The Integrated Goods and Services Tax (Amendment) Act, 2018 w.e.f 01.02.2019*

- (iii) provision of e-books, movie, music, software and other intangibles through telecommunication networks or internet;
- (iv) providing data or information, retrievable or otherwise, to any person in electronic form through a computer network;
- (v) online supplies of digital content (movies, television shows, music and the like);
- (vi) digital data storage; and
- (vii) online gaming;

Notification No. 02/2017 dated 19.06.2017 - Seeks to empower the Principal Commissioner of Central Tax, Bengaluru West to grant registration in case of online information and database access or retrieval services provided or agreed to be provided by a person located in non-taxable territory and received by a non-taxable online recipient

The definition has very wide coverage of activities/ services delivered in the digital economy and is drafted in line with the provisions under the Service Tax laws to include services like e-downloads of games, movies etc., web-hosting services, online supply of on-demand disc space, distance teaching, etc.

An indicative list of services that would not be covered under Online Information and Database Access or Retrieval (OIDAR) services are:

- Legal services or Financial services advising clients through e-mail
- Educational or professional courses, where the content is delivered by a teacher over the internet or an electronic network (using a remote link)

Following aspects need to be noted:

- Supply of Online Information and Database Access or Retrieval (OIDAR) services by a person located in a non-taxable territory (outside India) to a non-taxable online recipient, would be liable to tax in the hands of the supplier;
- The supplier would be responsible for collection and remittance of integrated tax to the Government of India;
- The supplier can take a single registration under the Simplified Registration Scheme (yet to be notified by the Government);
- Alternatively, a person located in India representing the supplier can obtain registration and pay the tax on behalf of the supplier. If the supplier does not have a representative/ physical presence in India, he can appoint a person who will be liable to pay the integrated tax on such transactions by providing the details of the State of consumption;
- Business-to-Business (B2B) transactions w.r.t. OIDAR will be taxable in the hands of the recipient itself under reverse charge mechanism.

(18) "output tax", in relation to a taxable person, means the integrated tax chargeable under this Act on taxable supply of goods or services or both made by him or by his agent but excludes tax payable by him on reverse charge basis;

The output tax i.e. integrated tax chargeable on inter-State taxable supply of goods or services can be summarised as under:

Type of Supply	Reference
Supplies between 2 States (or UT with Legislature)	Section 7(1) and 7(3) of the IGST Act
Import of goods or services	Section 7(2) and Section 7(4) of the IGST Act
Supplies to/ by a SEZ developer or unit	Section 7 (5) (b) of the IGST Act
Supplies made by a person located in India and where the place of supply is outside India	Section 7 (5) (a) of the IGST Act

Following aspects need to be noted:

- While input tax is in relation to a registered person, output tax is in relation to a taxable person. Evidently, the law excludes persons who are not registered under the law from being associated with any input tax. However, where there is a liability due to the Government, the law paves the way to cover those persons who are liable to tax, but who have failed to obtain registration.
- The amount covered under this term is the amount of tax that is 'chargeable', and not the amount that is 'charged'. Therefore, in case a person wrongly charges tax, or charges an excess rate of tax, as compared to the applicable tax rate, such excess would not qualify as output tax.
 - The taxes payable by recipient of supply, on account of making inward supplies of such categories of supply as are notified for the purpose of reverse chargeability of tax, or making inward supplies from unregistered persons, would be out of the scope of 'output tax'.
- The implication of the exclusions mentioned above is that the input tax credit cannot be utilised for making payment of any amount that does not qualify as output tax. Discharge of liability in such cases has to be by way of cash payments (i.e., through the electronic cash ledger, on depositing money by means of cash, cheque, etc.).
- The law makes a specific inclusion in respect of supplies made by an agent on behalf of the supplier, to treat the tax paid on such supplies as output tax in the hands of the supplier.

(19) "Special Economic Zone" shall have the same meaning as assigned to it in clause (za) of section 2 of the Special Economic Zones Act, 2005;

It covers two categories of zones as under:

- (a) Zones which are existing as on 10.02.2006 i.e. the date when SEZ Act was made effective.
- (b) Zones which have been notified under section 3(4) and section 4(1) of the SEZ Act, 2005.

Notifications under section 3(4) are issued when the State Government wants to set up a SEZ and the Notifications under section 4(1) are issued when any other person (except State Government) wants to set-up a SEZ. The notifications issued therein specify the SEZ area.

(20) "Special Economic Zone developer" shall have the same meaning as assigned to it in clause (g) of section 2 of the Special Economic Zones Act, 2005 and includes an Authority as defined in clause (d) and a Co-Developer as defined in clause (f) of section 2 of the said Act;

The term "Special Economic Zone developer" covers the following persons:

- (a) Person/ State Government who has been granted a letter of approval by the Central Government
- (b) Special Economic Zone Authority
- (c) Co-developer

Where the State Government/ person wants to set up a SEZ, notifications are required to be issued under section 3(4) and section 4(1) of the SEZ Act, 2005, respectively and after fulfilment of the prescribed conditions and procedures, a letter of approval is granted. Such a person who has been granted a letter of approval is regarded as a developer.

A co-developer is a person who has been granted a letter of approval for providing infrastructure facilities or for carrying out authorized operations in a notified SEZ. The Board of Approval (BOA) may specify the facility required to be developed by such a co-developer and in such a case, the co-developer will enter into an agreement with the developer for the specified purpose.

Supplies made to SEZ developer/ unit would be regarded as zero-rated supplies.

(21) "supply" shall have the same meaning as assigned to it in section 7 of the Central Goods and Services Tax Act;

The concept of 'supply' has been discussed in detail in the analysis of 'Supply'.

(22) "taxable territory" means the territory to which the provisions of this Act apply;

It covers the whole of India including the State of Jammu and Kashmir.

(23) "zero-rated supply" shall have the meaning assigned to it in section 16;

The following taxable supplies of goods and/ or services are considered as 'zero rated supplies':

- (a) Export of goods or services or both

(b) Supply of goods or services or both to a SEZ developer or SEZ unit

Input tax credit can be availed for making zero-rated supplies, even though such zero-rated supplies may be an exempt supply.

A taxable person exporting goods or services would be eligible for refund under the following two options:

- Export under bond/ LUT without payment of integrated tax and claim refund of unutilised input tax credit; or
- Export on payment of integrated tax which can be claimed as refund accordingly.

(24) words and expressions used and not defined in this Act but defined in the Central Goods and Services Tax Act, the Union Territory Goods and Services Tax Act and the Goods and Services Tax (Compensation to States) Act shall have the same meaning as assigned to them in those Acts;

Certain words and expressions like person, supplier, recipient, reverse charge, time of supply, value of supply etc. defined in the CGST/ UTGST/ GST (Compensation to States) laws will have the same meaning for the purpose of IGST law.

(25) any reference in this Act to a law which is not in force in the State of Jammu and Kashmir, shall, in relation to that State be construed as a reference to the corresponding law, if any, in force in that State.

Chapter 2

Administration

3. **Appointment of officers**
4. **Authorisation of officers of State tax or Union territory tax as proper officer in certain circumstances**

Statutory Provisions

<p>3. Appointment of officers</p> <p><i>The Board may appoint such central tax officers as it thinks fit for exercising the powers under this Act.</i></p> <p>4. Authorisation of officers of State tax or Union territory tax as proper officer in certain circumstances</p> <p><i>Without prejudice to the provisions of this Act, the officers appointed under the State Goods and Services Tax Act or the Union Territory Goods and Services Tax Act are authorised to be the proper officers for the purposes of this Act, subject to such exceptions and conditions as the Government shall, on the recommendations of the Council, by notification, specify.</i></p>

Section or Rule	Description
Section 2(36)	Definition of Council (CGST)
Section 2(80)	Definition of Notification (CGST)
Section 3	Officers under this Act (CGST)
Section 4	Appointment of Officers (CGST)
Section 5	Powers of Officers (CGST)
Section 6	Authorisation of officers of State tax or Union territory tax as proper officer in certain circumstances
Section 20	Application of provisions of Central Goods and Services Tax Act

Notification No. 02/2017 – CGST dated 19.06.2017 - Jurisdiction of Central Tax Officers - CGST officers

3.1/4.1 Introduction

Although CGST and IGST are both taxes of the Union, it is required that lawful authority be vested in certain persons to discharge duties for purposes of Integrated Tax.

3.2/4.2 Analysis

It is for this reason that the board has been empowered to appoint Central tax officers to discharge duties under the IGST Act. Please note that appointment of officers remains with the government but confirmation of responsibility to act as integrated tax officers is left with the Board.

Suitable enabling provisions have also been made, whereby officers of State / UT Tax can be authorised to discharge functions under the IGST Act. Such a provision is necessary in order to maintain uniformity in administration of notified supplies or notified category of taxable persons which are exclusively left under the CGST Act to be administered by officers of State / UT Tax. It is appreciable that careful consideration has been given to ensure that there is no duplication of administrative power at the same time sufficient flexibility is enabled to ensure smooth and seamless tax compliance experience for trade and industry in GST regime.

Chapter 3

Levy and Collection of Tax

5. Levy and Collection

6. Power to grant exemption from tax

Statutory provisions - Effective from 1st July, 2017 to 31st January, 2019

5. Levy and Collection

- (1) *Subject to the provisions of sub-section (2), there shall be levied a tax called the integrated goods and services tax on all inter-State supplies of goods or services or both; except on the supply of alcoholic liquor for human consumption, on the value determined under section 15 of the Central Goods and Services Tax Act and at such rates, not exceeding forty per cent., as may be notified by the Government on the recommendations of the Council and collected in such manner as may be prescribed and shall be paid by the taxable person:*

Provided that the integrated tax on goods imported into India shall be levied and collected in accordance with the provisions of section 3 of the Customs Tariff Act, 1975 on the value as determined under the said Act at the point when duties of customs are levied on the said goods under section 12 of the Customs Act, 1962.

- (2) *The integrated tax on the supply of petroleum crude, high speed diesel, motor spirit (commonly known as petrol), natural gas and aviation turbine fuel shall be levied with effect from such date as may be notified by the Government on the recommendations of the Council.*
- (3) *The Government may, on the recommendations of the Council, by notification, specify categories of supply of goods or services or both, the tax on which shall be paid on reverse charge basis by the recipient of such goods or services or both and all the provisions of this Act shall apply to such recipient as if he is the person liable for paying the tax in relation to the supply of such goods or services or both.*
- (4) *The integrated tax in respect of the supply of taxable goods or services or both by a supplier, who is not registered, to a registered person shall be paid by such person on reverse charge basis as the recipient and all the provisions of this Act shall apply to such recipient as if he is the person liable for paying the tax in relation to the supply of such goods or services or both.*
- (5) *The Government may, on the recommendations of the Council, by notification, specify categories of services, the tax on inter-State supplies of which shall be paid by the electronic commerce operator if such services are supplied through it, and all the provisions of this Act shall apply to such electronic commerce operator as if he is the*

supplier liable for paying the tax in relation to the supply of such services:

Provided that where an electronic commerce operator does not have a physical presence in the taxable territory, any person representing such electronic commerce operator for any purpose in the taxable territory shall be liable to pay tax:

Provided further that where an electronic commerce operator does not have a physical presence in the taxable territory and also does not have a representative in the said territory, such electronic commerce operator shall appoint a person in the taxable territory for the purpose of paying tax and such person shall be liable to pay tax

Statutory provisions - Effective from 1st February, 2019 vide The Integrated Goods and Services Tax Amendment Act, 2018

5. Levy and Collection

- (1) *Subject to the provisions of sub-section (2), there shall be levied a tax called the integrated goods and services tax on all inter-State supplies of goods or services or both; except on the supply of alcoholic liquor for human consumption, on the value determined under section 15 of the Central Goods and Services Tax Act and at such rates, not exceeding forty per cent., as may be notified by the Government on the recommendations of the Council and collected in such manner as may be prescribed and shall be paid by the taxable person:*
- Provided that the integrated tax on goods imported into India shall be levied and collected in accordance with the provisions of section 3 of the Customs Tariff Act, 1975 on the value as determined under the said Act at the point when duties of customs are levied on the said goods under section 12 of the Customs Act, 1962.*
- (2) *The integrated tax on the supply of petroleum crude, high speed diesel, motor spirit (commonly known as petrol), natural gas and aviation turbine fuel shall be levied with effect from such date as may be notified by the Government on the recommendations of the Council.*
- (3) *The Government may, on the recommendations of the Council, by notification, specify categories of supply of goods or services or both, the tax on which shall be paid on reverse charge basis by the recipient of such goods or services or both and all the provisions of this Act shall apply to such recipient as if he is the person liable for paying the tax in relation to the supply of such goods or services or both.*
- (4) *The Government may, on the recommendations of the Council, by notification, specify a class of registered persons who shall, in respect of supply of specified categories of goods or services or both received from an unregistered supplier, pay the tax on reverse charge basis as the recipient of such supply of goods or services or both, and all the provisions of this Act shall apply to such recipient as if he is the person liable for paying the tax in relation to such supply of goods or services or both."*
- (5) *The Government may, on the recommendations of the Council, by notification, specify*

categories of services, the tax on inter-State supplies of which shall be paid by the electronic commerce operator if such services are supplied through it, and all the provisions of this Act shall apply to such electronic commerce operator as if he is the supplier liable for paying the tax in relation to the supply of such services:

Provided that where an electronic commerce operator does not have a physical presence in the taxable territory, any person representing such electronic commerce operator for any purpose in the taxable territory shall be liable to pay tax:

Provided further that where an electronic commerce operator does not have a physical presence in the taxable territory and also does not have a representative in the said territory, such electronic commerce operator shall appoint a person in the taxable territory for the purpose of paying tax and such person shall be liable to pay tax

Notification No. 18/2017 -TRU Dated 5th July, 2017 - IGST exemption to SEZs on import of Services by a unit/developer in an SEZ;

Notification No. 03/2017 – Integrated Tax dated 28.06.2017 - Seeks to bring into force certain sections of the IGST Act, 2017 w.e.f 01.07.2017

Circular No. 1/1/2017-IGST dated 07.07.2017 - Clarification on Inter-state movement of various modes of conveyance, carrying goods or passengers or for repairs and maintenance

Circular No. 21/21/2017-GST dated 22.11.2017 - Clarification on Inter-state movement of rigs, tools and spares, and all goods on wheels [like cranes]

Circular No. 22/22/2017-GST dated 21.12.2017 - Clarification on issues regarding treatment of supply by an artist in various States and supply of goods by artists from galleries

Circular No. 27/01/2018-GST dated 04.01.2018 - Clarifications regarding levy of GST on accommodation services, betting and gambling in casinos, horse racing, admission to cinema, homestays, printing, legal services etc.,

Circular No. 34/8/2018-GST dated 01.03.2018 - Clarifications regarding GST in respect of certain services

Circular No. 35/9/2018-GST dated 05.03.2018 - Joint Venture - taxable services provided by the members of the Joint Venture (JV) to the JV and vice versa and inter se between the members of the JV

5.1 Introduction

The Constitution mandates that no tax shall be levied or collected by a taxing Statute except by authority of law. While no one can be taxed by implication, a person can be subject to tax in terms of the charging section only.

This is the charging provision of the IGST Act. It provides that all inter-State supplies would be liable to IGST at rate recommended by the Council and notified subject to a ceiling rate of 40%. The provision of this section is comparable to the provision under section 9 of the CGST Act and section 7 of the UTGST Act.

The levy is on all goods or services or both except alcoholic liquor for human consumption. Further, GST may be levied in supply of petroleum crude, high spirit diesels, motor spirit (petrol), natural gas and aviation turbine fuel with effect from the date notified by the Government on the recommendations of GST Council.

The levy of tax on supply of goods and / or services is in three parts - (i) in the hands of the supplier and (ii) in the hands of the recipient of goods / services under reverse charge mechanism and, (iii) in case of specified services, in the hands of electronic commerce operator

5.2 Analysis

In terms of section 2(24) of the Act, any words or expression which are used in this Act, but are not defined should be assigned the meaning as given to such words or expressions in the CGST Act, the UTGST Act, and the GST (Compensation to States) Act.

With specific reference to this section, the following words/ expressions would be relevant-

- Supply
- Inter-State supply
- Goods
- Services
- Taxable person

The meaning to the expression 'inter-State supply' can be understood from section 7 of this Act. However, the meaning of 'supply' and 'taxable person' should be borrowed from the CGST Act. Reference may be made to the CGST Act for an in-depth understanding of such expressions and words.

Levy of tax: Every inter-State supply will be liable to tax, if:

- (i) There is a Supply either of goods or services or both, even when a supply involves goods or services or both the law provides that such supply would be classifiable only as goods or services in terms of Schedule II of the Act.
- (ii) The supply is an inter-State supply – viz. ordinarily, the location of the supplier and the place of supply are in different States. (Refer section 7 of the IGST Act to understand the meaning of inter-State supply);
- (iii) The tax shall be payable by a 'taxable person' as explained in section 2(107) read with section 22 and section 24 of the CGST Act.

Imports: Proviso to section 5(1) makes a very important exception in respect of "goods imported into India". Import of goods is defined in section 2(10) in a manner identical with the definition under Customs Act in section 2(23). The important exception made under the proviso is the carve out from the levy under section 5 supplies involving import of goods and

place such transactions under Customs Act and not under IGST Act. In other words, goods imported into India will be liable to IGST but not under IGST Act instead under section 3(7) of Customs Tariff Act. Vide Taxation Laws (Amendment) Act, 2017 sweeping changes have been brought about in Customs in the wake of introduction of GST. Amongst others, one significant change is that, in addition to basic customs duty levied under section 12 of Customs Act- section 3 of Customs Tariff Act - sub-section 7 levies IGST on import of goods. It merits to mention here is that sub-section 9 levies compensation cess wherever applicable when the said goods are imported into India.

Going back to the proviso to sub-section 1, the expression 'the point at which import duties are leviable' is very significant. Examination of the 'point of levy' under Customs Act reveals that goods brought into India are liable to customs duties at the time specified in section 15. Accordingly, no duties are levied until the bill of entry for home consumption is filed. Imported goods are defined in section 2(25) of Customs Act as:

"imported goods" means any goods brought into India from a place outside India but does not include goods which have been cleared for home consumption"

Goods that have been cleared for home consumption will cease to be imported goods. Goods which have entered India but not yet cleared for home consumption will not attract the levy of customs duty until bill of entry for home consumption is filed. Customs Act permits goods that have entered India to be deposited in a bonded warehouse on filing 'into-bond' bill of entry without payment of duty. Hence, goods that have entered India will not attract liability to IGST until they reach the point – location or time – when bill of entry for home consumption is ready to be filed.

Further, goods imported by SEZ also do not attract liability to IGST as the goods are 'not yet' liable to be assessed to customs duty. Section 53 of the SEZ Act states that:

53(1). A Special Economic Zone shall, on and from the appointed day, be deemed to be a territory outside the customs territory of India for the purposes of undertaking the authorized operations.

Please note the following aspects:

- Goods deposited in warehouse by filing into-bond bill of entry do not attract liability to any customs duty until the date specified in section 15 is reached;
- Goods received by EOU attracts liability to customs duty as notification 44/ 2016-Cus dated 29 July, 2016 has delicensed warehouse facility of EOUs and clarified vide Circular 35/ 2016 dated 29 July, 2016;
- Notification 15/ 2017-Integrated Tax (Rate) dated 30-Jun-17 issued granting exemption from IGST on import of goods by a SEZ and this exemption was immediately rescinded vide notification 18/2017- Integrated Tax (Rate) dated 5-Jul-17 as granting such an exemption would have been out of harmony with the concept that goods have 'not yet' reached the 'point' when liability to customs duty is attracted;

- Circular 35/ 2017-Cus dated 1 August, 2017 regarding high-sea sales states that IGST is applicable but deferred until bill of entry for home consumption is filed; Further, supplies made before the goods are cleared for home consumption has been considered as a Schedule III negative list entry as per the CGST Amendment Act, 2018 w.e.f. 01/02/2019.
- ORDER No. CT/2275/18-C3 DATED 26th March, 2018 passed by the AUTHORITY FOR ADVANCE RULING – KERALA clarifies that no tax is applicable on Merchanting trade applying the principles laid down in the aforesaid Circular No.35/2017-Cus dated 1 August, 2017. Further, such merchant trade transactions has been covered under Schedule III negative list as per the CGST Amendment Act, 2018 (Merchant Trade transactions are those transactions where the trader in one country A, purchases goods from country B and supply the goods to a buyer in country C. Thus, the goods never cross the Customs frontier of the country of trader); and
- Circular 46/ 2017-Cus dated 24 November, 2017 regarding in-bond sales makes it explicitly clear that IGST is not applicable until bill of entry for home consumption is filed.

In view of the foregoing, *proviso* to section 5(1) is of paramount importance which attracts the levy of IGST not before the bill of entry for home consumption is due to be filed in accordance with the provisions of Customs Act.

Supply: Refer discussion under section 7 of the CGST Act for a detailed understanding of the expression 'supply'. Additionally, the comments relating to 'composite supply' and 'mixed supply' will equally apply for supplies taxable under IGST Act.

Tax shall be payable by: The tax shall be payable by a 'taxable person' as defined under section 2(107) read with section 22 and section 24 of the CGST Act. Broadly, a taxable person is one who is registered or who is required to be registered under the GST law. Please refer to the discussion under the CGST Act for a thorough understanding of this concept.

Tax payable: Every inter-State supply falling under section 7 of the IGST Act will attract IGST, if it gets covered by section 5. However, all transactions covered within definition of supply in the course of inter-State trade or commerce within the meaning of section 7 does not mean that it is always subject to levy of IGST unless it falls in section 5 i.e. charging section.

Tax on import of goods: This Act provides that IGST shall be levied on import of goods in terms of section 3 of the Customs Tariff Act, 1975. It implies that on such importation of goods, IGST will be payable in addition to the Basic Customs Duty (BCD). The proviso to section 5(1) of the IGST Act also clarifies that the value and point at which IGST would be payable will be determined in accordance with section 12 of the Customs Act, 1962.

Rate and value of tax: The rate of tax notified separately, but shall not exceed 40%, and the value of supplies would be as determined under section 15 of the CGST Act.

Applicability in respect of e-commerce operators: Refer discussion under section 9(5) of the CGST Act for an understanding of the applicability of this provision for e-commerce operators.

Reverse charge mechanism: Normally, the supplier of goods and/ or services will be liable to discharge tax on the supplies effected. However, the Central Government is empowered to specify categories of supplies in respect of which the recipient of goods and/ or services will be liable to discharge the tax. *Notification No. 4/ 2017-Integrated Tax (Rate) dated 28-Jun-17 amended vide Notification No. 37/ 2017-Integrated Tax (Rate) dated 13-Oct-17, 2017, Notification No. 45/ 2017- Integrated Tax (Rate) dated 14-Nov-17 & 10/ 2017-Integrated Tax (Rate), dated 28-Jun-17 amended vide Notification No. 34/ 2017-Integrated Tax (Rate) dated 13-Oct-17* has been issued to notify the goods and services respectively where tax has to be paid by recipient of supply under reverse charge mechanism.

Similarly, registered person shall be liable to discharge the tax in respect of supply of taxable and/ or services by unregistered person. There is no threshold exemption limit in case of inter-State supply. Hence, if the supplier is located in one State and the place of supply is in another State, the recipient may not be required to pay tax in State where recipient is registered which is not the State where place of supply is dictated by law.

Accordingly, all other provisions of this Act and CGST Act, as applicable, will apply to the recipient of such goods and/ or services, as if the recipient is the person liable to pay tax in relation to supply of such goods and/ or services.

From the above amendment, the liability of reverse charge on the registered recipient on receiving supplies from unregistered supplier will be applicable only on (a) specified class of registered persons and (b) on specified categories of goods or services or both.

E-commerce: Where any supply of services is effected through e-commerce operator (commonly known as services provided by aggregator), the law provides that the Central / State Government may on recommendation of the Council specify (notify) that the e-commerce operator will be liable to discharge the tax on such supplies. It is important to note that, in such supplies, the e-commerce operator is neither the actual supplier of service/s nor does he actually receive the services. The actual supplier of services is a third party who provides such service to the customer through e-commerce operator. Instead of levying tax on such actual supplier, the law has imposed levy on e-commerce operator. Therefore, this would be an exception to the imposition of tax as specified in para supra. It is important to note that this exception is carved out only in respect of supply of services through an e-commerce operator and will not be applicable / relevant to supply of any goods through an e-commerce operator. *Notification No. 14/ 2017-Integrated Tax (Rate) dated 28-Jun-17 amended vide Notification No. 23/ 2017-Integrated Tax (Rate) dated 22-Aug-17* has been issued to provide that in case of the following categories of services, the tax on inter-State supplies shall be paid by the electronic commerce operator.

- (i) services by way of transportation of passengers by a radio-taxi, motorcab, maxicab and motor cycle;
- (ii) services by way of providing accommodation in hotels, inns, guest houses, clubs, campsites or other commercial places meant for residential or lodging purposes, except where the person supplying such service through electronic commerce operator is liable for registration under clause (v) of section 20 of the Integrated Goods and Services Tax Act, 2017 read with sub-section (1) of section 22 of the said Central Goods and Services Tax Act.
- (iii) services by way of house-keeping, such as plumbing, carpentering etc, except where the person supplying such service through electronic commerce operator is liable for registration under clause (v) of section 20 of the Integrated Goods and Services Tax Act, 2017 read with sub-section (1) of section 22 of the said Central Goods and Services Tax Act.

In case where the e-commerce operator:

- (a) Does not have a physical presence then the person who represents the e-commerce operator will be liable to pay tax.
- (b) Does not have a physical presence or a representative, then the e-commerce operator is mandatorily required to appoint a person who will be liable to pay tax.

5.3 Comparative review

Under the erstwhile tax laws, Central Excise is on 'manufacture of goods', VAT/ CST is on 'sale of goods' and Service tax is on 'provision of service'. Unlike different incidences under erstwhile law in a GST regime, 'it is supply which is a taxable event'. Further, free supplies would be liable to excise duty, while under the VAT laws, free supplies would require reversal of input tax credit; Unlike different incidences, under the GST law, it is 'supply' which would be the taxable event. Under the erstwhile law, e.g.: while stock transfers are liable to Central Excise (if they are removed from the factory), it would not be liable to VAT/ CST. However, under the GST law, it would be taxable as a 'supply'.

Under the erstwhile laws, there are multiple transactions which apparently qualify as both 'sale of goods' as well as 'provision of services'. E.g. license of software, providing a right to use a brand name, etc. Unlike this situation, GST clarifies as to whether a transaction would qualify as a 'supply of goods' or as 'supply of services'. A transaction would either qualify as goods or as services, under the GST law. Even in respect of composite contracts, it has been clarified under Schedule II, definitions of composite supply and mixed supply in the CGST law.

The payment of VAT by the purchaser (registered dealer) on purchase of goods from an unregistered dealer and the circumstances where the Service Tax is payable under the reverse charge mechanism, in respect of say, import of services, sponsorship services etc., are comparable to the 'reverse charge mechanism' prescribed herein. However, under GST

law, the Central Government can notify class of goods which are a subject matter of reverse charge.

The detailed analysis of Chapter 3 – Levy and Collection of taxes under the Central Goods and Service Tax may also be referred.

5.4 Related provisions of the Statute

Statute	Section	Description
IGST	Section 7	Meaning of inter-State supplies
CGST	Section 9	Levy and collection of CGST/ SGST
CGST	Section 7 read with Schedule I, II and III	Definition of 'supply'
CGST	Section 2(107) read with section 22 and section 24	Meaning of 'taxable person'
CGST	Section 2(17)	Definition of 'Business'

5.5 FAQs

Q1. Will sale of business as a whole be liable to tax?

Ans. Clause (d) of section 2(17) of the CGST Act provides that supply or acquisition of goods including capital goods and services in connection with commencement or closure of business is also included in the term "business". Therefore, the goods element in the sale of business, would be regarded as 'supply' and therefore, liable to tax.

One may also refer to Entry No. 4(c) of Schedule II which specifies listed number of issues when it will not be taxable.

Q2. Is the reverse charge mechanism applicable only to services?

Ans. No, section 5(3) or 5(4) of the IGST Act and section 9(3) or 9(4) of the CGST Act does not limit reverse charge to services, it applies to goods also. Notification No. 04/ 2017-Central Tax (Rate), dated 28-06-2017 as amended from time to time has been issued to provide the cases where tax has to be paid by recipient of supply of goods under reverse charge mechanism. This includes the Cashew nuts, not shelled or peeled, Bidi wrapper leaves (tendu), Tobacco leaves, Silk yarn, Supply of lottery, used vehicles, seized and confiscated goods, old and used goods, waste and scrap, raw cotton when supplied by specified suppliers.

Q3. What will be the implications in case of purchase of goods from unregistered dealers?

Ans. As per section 5(4) of the IGST Act, 2017 as amended by The IGST Amendment Act, 2018 specified that the tax shall be payable under reverse charge by the specified class of registered persons, in respect of supply of specified categories of goods.

Q4. In respect of exchange, will the transaction be taxable as two different supplies or will it be taxable only in the hands of the main supplier?

Ans. Taxable as two different supplies. Exchange from point of view of each party will need to be examined if it attracts the requirements of levy of tax.

Q5. In respect of exchange or barter, if one supply is intra-State and another is inter-State, how will the taxes be applicable?

Ans. There are two separate supplies and taxes as applicable (as inter-State and/ or intra-State respectively).

Q6. What are examples of 'disposals' as used in supply?

Ans. Sale of old furniture by a garment manufacturer.

Note: Disposal is where the articles are being cleared up and not necessarily as the main object of the business.

Q7. Will a Bank qualify as a taxable person for sale of hypothecated/ pledged goods (auction)?

Ans. Yes, the nature of business as a bank does not affect tax liability. GST is payable if there is any supply of goods or services even by a bank.

Q8. Will an Insurance company be a taxable person for sale of repossessed goods?

Ans. Yes. Although not the principal source of income, sale of repossessed goods is key aspect of insurance business.

Q9. Will a "not for profit entity" be liable to tax on any sales effected by it – e.g.: sale of assets received as donation?

Ans. Yes. NPEs do not distribute profit to promoters but that does not exclude from doing activities that conform to definition of business.

Statutory provisions

6. Power to grant exemption from tax

- (1) *Where the Government is satisfied that it is necessary in the public interest so to do, it may, on the recommendations of the Council, by notification, exempt generally, either absolutely or subject to such conditions as may be specified therein, goods or services or both of any specified description from the whole or any part of the tax leviable thereon with effect from such date as may be specified in such notification.*
- (2) *Where the Government is satisfied that it is necessary in the public interest so to do, it may, on the recommendations of the Council, by special order in each case, under circumstances of an exceptional nature to be stated in such order, exempt from payment of tax any goods or services or both on which tax is leviable.*
- (3) *The Government may, if it considers necessary or expedient so to do for the purpose of clarifying the scope or applicability of any notification issued under sub-section (1)*

or order issued under sub-section (2), insert an Explanation in such notification or order, as the case may be, by notification at any time within one year of issue of the notification under sub-section (1) or order under sub-section (2), and every such Explanation shall have effect as if it had always been the part of the first such notification or order, as the case may be.

Explanation.— For the purposes of this section, where an exemption in respect of any goods or services or both from the whole or part of the tax leviable thereon has been granted absolutely, the registered person supplying such goods or services or both shall not collect the tax, in excess of the effective rate, on such supply of goods or services or both.

6.1 Introduction

This provision states that the Central Government may grant exemptions for inter-State supply of certain goods and/ or services. Reference may also be made to section 11 of the CGST Act and section 8 of the UTGST Act for a better understanding.

6.2 Analysis

The Central Government will be empowered to grant exemptions from payment of IGST on inter-State supplies, subject to the following conditions:

- (i) Exemption should be in public interest
- (ii) By way of issue of notification
- (iii) On recommendation from the Council
- (iv) Absolute/ conditional exemption may be for any goods and/ or services
- (v) Exemption by way of special order (and not notification) may be granted by citing the circumstances which are of exceptional nature

With specific reference to the fourth condition indicated above, it is important to note that the exemption would only be in respect of goods and/ or services, and not specifically for classes of persons.

E.g.: An absolute exemption could be granted in respect of supply of fertiliser. A conditional exemption could be supply of fertiliser subject to the condition that no input tax credit has been claimed in respect of inputs and capital goods.

Exemption by way of special order is where the exemption is issued for a specific purpose. E.g. Exemption to imports made for a defence project during the times of emergency.

Mandatory nature of absolute exemptions has been litigated in the past and where tax is paid even though exemption is available, credit becomes admissible. For this reason, absolute exemptions have been made compulsory. As such, credit denial also becomes absolute. No plea of equity or revenue neutrality becomes admissible.

There is generally not much doubt about exemptions – whether absolute or conditional – because the condition associated may be examined at one-time or continuously to be satisfied. Conditional exemptions abate if the associated condition is not complied. Care should be taken not to mistake conditional exemption with absolute exemption having specific applicability.

From the explanation provided after sub-section (2), there is one school of thought wherein it is opined/ understood that in case of conditional exemptions, there is an option available to the taxable person to pay the tax (by which way, there would be no requirement for input tax credit reversals). However, an absolute exemption is required to be followed mandatorily. The other view is that exemptions would never be optional, and would be mandatory automatically when the conditions relating to the exemption are satisfied. This provision does not bring in any clarity on this issue.

In terms of sub-section (2), the Government may issue a special order on a case-to-case basis. The circumstances of exceptional nature would also have to be specified in the special order. While this provision is welcome, industry is apprehensive that this could be used without necessary superintendence.

To provide more clarity to the exemption notification or the special order, it is provided that the Government may issue an “Explanation” at any time within a period of one year from the date of issue of notification or special order. The effect of this “Explanation” would be retrospective, viz., from the effective date of the relevant notification or special order.

The law mandates that when the exemption is absolute (i.e., if whole or part of tax leviable is exempt) the registered person cannot collect taxes in excess of the effective rate.

Exemption under section 11 of the CGST/ SGST Act equally applicable

Any exemption notification or special order issued under section 11 of the CGST Law will apply equally for inter-State supplies, viz., any supply of goods or services or both which are exempt under CGST Law will be exempt even under the IGST Law

Effective date of the notification or special order

The effective date of the notification or the special order would be date which is so mentioned in the notification or special order. However, if no date is mentioned therein, it would come into force on the date of its issue by the Central Government for publication in the Official Gazette. It follows that such notification/ order shall be made available on the official website of the department of the Central Government.

Exemption under CGST Act	Deemed to exempt under SGST Act
	Deemed to exempt under UTGST Act
Exemption under IGST Act	No auto-application of exemption

Exemptions issued under IGST Act:

Following exemptions have been issued under IGST Act:

- Notification No. 07/ 2017-Integrated Tax (Rate), dated 28-06-2017: Exemption from IGST supplies by CSD to Unit Run Canteens and supplies by CSD/ Unit Run Canteens to authorised customers under section 6(1).
- Notification No. 9/ 2017-Integrated Tax (Rate) dated 28-Jun-17: Mega exemption list for supply of service amended vide Notification No.21/2017 dated 22- Aug-17, 29/2017 dated 29-Sept-17, 33/2017 dated 13-Oct-17, 42/2017 dated 27-Oct-17. The exemption notification covers entries where services supplied by supplier of service has been exempted from levy of GST.
- Notification No. 18 /2017-Integrated Tax (Rate) dated 5-Jul-17: IGST exemption to SEZs on import of Services by a unit/ developer in a SEZ.
- Notification No. 31/2017- Integrated Tax (Rate) dated 29-Sept-17: Exempting supply of services associated with transit cargo to Nepal and Bhutan.
- Notification No.41/2017 – Integrated Tax (Rate) dated 23-Oct-17: Exempting integrated tax on inter-state supply of taxable goods by a registered supplier to a registered recipient in excess of 0.1%, subject to fulfilment of conditions in the notification. This transaction commonly known as ‘penultimate sale’ / sale against ‘Form H’ under the existing law, was completely exempt from tax on production of Form H.
- Notification No.42/2017 - Integrated Tax (Rate) dated 27-Oct-2017: Exempting supply of service having place of supply in Nepal or Bhutan, against payment in Indian Rupees

The detailed analysis of Chapter 3 – Levy and Collection of taxes under the Central Goods and Service Tax may also be referred.

6.3 Comparative review

The provisions relating to exemption are broadly similar to the exemption provisions under the erstwhile tax regime. There are no significant differences.

6.4 Related provisions of the Statute:

Statute	Section	Description
CGST	Section 11	Exemption from payment of CGST/ SGST
UTGST	Section 8	Power to grant exemption from tax

6.5 FAQs

Q1. Can an exemption be granted for inter-State supplies when such an exemption is not granted for intra-State supplies?

Ans. Yes.

Q2. Can the Central Government issue a special order for exemptions that are only meant for transactions liable to IGST?

Ans. Yes.

Q3. Is the State Government empowered to grant exemption by way of a special order for inter-State supplies?

Ans. No. The State Government is not empowered to grant exemptions on any inter-State supplies.

Chapter 4

Determination of Nature of Supply

7. **Inter-State supply**
8. **Intra-State supply**
9. **Supplies in territorial waters**

Statutory provisions

7. Inter-State Supply

- (1) *Subject to the provisions of section 10, supply of goods, where the location of the supplier and the place of supply are in—
 - (a) two different States;
 - (b) two different Union territories; or
 - (c) a State and a Union territory,shall be treated as a supply of goods in the course of inter-State trade or commerce.*
- (2) *Supply of goods imported into the territory of India, till they cross the customs frontiers of India, shall be treated to be a supply of goods in the course of inter-State trade or commerce.*
- (3) *Subject to the provisions of section 12, supply of services, where the location of the supplier and the place of supply are in—
 - (a) two different States;
 - (b) two different Union territories; or
 - (c) a State and a Union territory,shall be treated as a supply of services in the course of inter-State trade or commerce.*
- (4) *Supply of services imported into the territory of India shall be treated to be a supply of services in the course of inter-State trade or commerce.*
- (5) *Supply of goods or services or both, —
 - (a) when the supplier is located in India and the place of supply is outside India;
 - (b) to or by a Special Economic Zone developer or a Special Economic Zone unit; or
 - (c) in the taxable territory, not being an intra-State supply and not covered elsewhere in this section, shall be treated to be a supply of goods or services or both in the course of inter-State trade or commerce.*

Related Provisions of the Statute

Statute	Section / Rule	Description
IGST	Section 2(4)	Definition of customs frontier of India
IGST	Section 2(5)	Definition of export of goods
IGST	Section 2(6)	Definition of export of service
IGST	Section 2(10)	Definition of import of goods
IGST	Section 2(11)	Definition of import of service
IGST	Section 2(15)	Definition of location of supplier of service
IGST	Section 2(19)	Definition of Special Economic Zone
IGST	Section 2(20)	Definition of Special Economic Zone developer
CGST	Section 2(56)	Definition of India
CGST	Section 2(103)	Definition of State
CGST	Section 2(114)	Definition of Union Territory
IGST	Section 10	Place of supply of goods other than supply of goods imported into, or exported from India
IGST	Section 12	Place of supply of services where location of supplier and recipient is in India
IGST	Section 15	Refund of IGST paid on supply of goods to tourist leaving India
IGST	Section 5	Levy and collection of tax
CGST	Section 9	Levy and collection of tax
CGST	Section 25	Registration

7.1 Introduction

Having examined levy and the scope and coverage of supply, the next aspect to determine is the nature of supply so as to identify the right kind of tax applicable in a given case. It is important to note that nature of supply is not a question of fact but the result of application of the law to the fact, which provides us the answer. Concluding the answer about the nature of tax is paramount importance not only for the selection of the right kind of tax but also to recognise the departure of GST from the well understood principles under the erstwhile law.

Nature of supply does not refer to 'place of supply'. The next Chapter deals with place of supply but before getting into place of supply it is important to understand the nature of supply. There are very specific principles laid down that need to be identified from the facts in each transaction in order to determine the nature of supply that is involved. This section

provides as to when the supplies of goods and/or services shall be treated as Supply in the course of inter-State trade/commerce.

Section 7(1) and 7(2) of IGST Act, primarily covers two kinds of supplies – Supply of **goods** within India and supply of **goods** imported into India respectively and Section 7(3) and 7(4) of IGST Act, covers two kinds of supplies – supply of **services** within India and import of **services** into India respectively. Certain supplies of goods or services are treated as supplies in the course of inter-State trade or commerce as defined in Section 7(5) of the IGST Act.

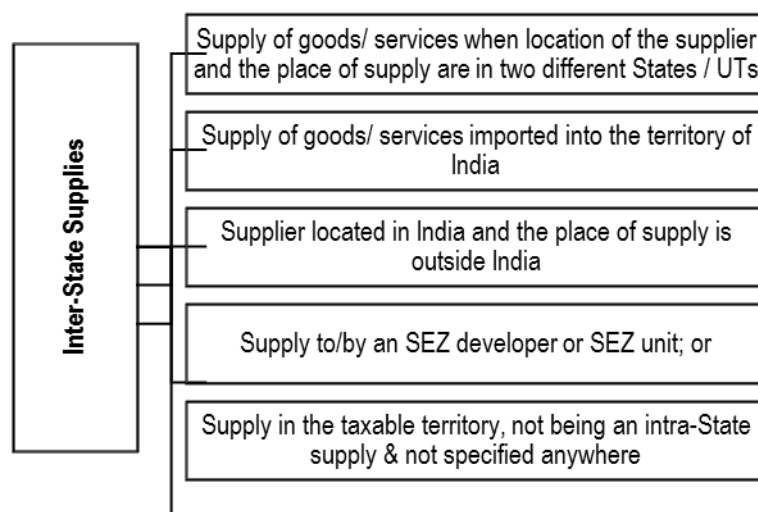

7.2 Analysis

Inter-State supply of goods

At the outset one may need to bear in mind the treatment extended to the subject matter of supply, that is, whether the supply is of goods or services or both or supply involving goods but treated as supply of services in terms of the fiction specified in Schedule II of CGST Act, 2017. In respect of goods (treated as goods), if the location of the supplier and the place of supply are in two different States or UT or either, then the supply will be in the course of inter-State trade or commerce (amongst others).

We need to pause here and examine the two terms that have been used, namely:

- (a) **Location of supplier** – Unlike in the case of services, location of supplier of goods is a term that is not defined in the law. This is not an oversight of the draftsmen but a deliberate intention of the lawmakers to leave it to the facts of each case to determine the 'location of supplier of goods'. For example, if a company incorporated in Delhi were to place a purchase order on a manufacturer in Maharashtra to produce certain articles and sell it on ex-works basis with instructions to retain it until further instructions. This would be a case where the manufacturer in Maharashtra would like to charge IGST because the purchase order is from a customer in Delhi. In this supply, the location of supplier is Maharashtra and place of supply is also Maharashtra. Therefore, the

manufacturer is required to charge CGST/ SGST because this supply does not involve any movement and due to the instructions (or lapse of time) delivery is complete in Maharashtra itself. Now, if instructions are subsequently issued to dispatch the goods to a warehouse in Madhya Pradesh, the supply by the manufacturer having been completed long before these dispatch instructions are received, there is a new supply emerging from Maharashtra to Madhya Pradesh but the supplier in this instance will be the Company in Delhi and not by the manufacturer-supplier in Maharashtra. One supplier can effect supply only once of the given goods. In this new supply, the location of supplier can either be Delhi – registered place of business – or Maharashtra – the physical point where the goods are situated. The location of the registered place of business (Delhi) cannot guide the decision regarding the nature of supply but will be guided by their location 'under the control' of the supplier (Company in Delhi)). The point where goods are situated better represents the location of supplier. The location of supplier is therefore the physical point where the goods are situated under the control of the person wherever incorporated or registered, ready to be supplied. This interpretation augurs well with the concept of casual taxable person. The company in Delhi that collects delivery of the goods in Maharashtra and supplies them from Maharashtra to Madhya Pradesh must be regarded as casual taxable person in Maharashtra liable to pay IGST on this supply.

If, however, the delivery by the manufacturer is not completed ex-works but retained to be delivered to Madhya Pradesh at the instruction of the customer in Delhi, then it would be a case of supply from Maharashtra to Delhi and a further supply from Delhi to Madhya Pradesh, regardless of how the goods move. Generally, we can identify the examples where the location of supplier of goods is more accurately determined by the physical point where the goods are located (under the control of the person wherever incorporated or registered), and ready to be supplied.

However, there may be a few exceptions to the rule stated above:

- a) In case of in-transit sales, the principle of the location of supplier as the place where the goods are held in the control of the supplier may not be possible to be determined. In such cases, the place where goods were held before being dispatched should be taken. In this case, the place where the goods are actually present cannot be taken.

E.g. A person in West Bengal is instructing his supplier in Delhi to supply the goods directly to his customer in Maharashtra while the goods are in transit. For the second leg of the transaction i.e. the supply between the person in West Bengal and the one in Maharashtra, the location of goods may not be determinable. In such a case, the location of supplier for this leg of the transaction will be considered as West Bengal even though the goods never reach West Bengal.

- b) As per Circular no. 10/10/2017-GST dated 18th October 2017, clarification was given in a case where the suppliers are registered in a state but have to visit other

states other than their state of registration and need to carry the goods for approval. In such case, if the goods are approved the invoice is issued at the time of supply. It was clarified that all such supplies, where the supplier carries goods from one State to another and supplies them in a different State, will be inter-state supplies and attract integrated tax in terms of Section 5 of the Integrated Goods and Services Tax Act, 2017. In such case also, the location of supplier is the place where the supplier is registered and not the place where the goods are actually present when they are approved. Even though this is in contradiction with the concept of Casual Taxable person which requires the supplier to register in the state where he is carrying the goods, this clarification was provided for the ease of trade and industry. One may wonder if this can be considered as a reasonable basis for questioning the generic principle of determination of the location of the supplier.

- c) One of the Advance ruling judgements presents a point of view which may have to be considered while taking a decision. In case of Sonkamal Enterprises Private Limited under the Maharashtra Authority for Advance Ruling (2018-TIOL-301-AAR-GST). It was stated that invoice can be raised from Mumbai Head office for imports received at Haldia Port, Kolkata by the company where no separate registration is there in West Bengal if supplies are directly made from the customs bonded warehouse within West Bengal. Here, IGST will be charged from Mumbai to the customer and no separate registration will be required in West Bengal. So, even though the goods are lying in West Bengal when the goods are supplied to the customer, the location of supplier of goods will be that of the registered place of business of the supplier i.e. Mumbai.
- (b) **Place of supply** – It appears to be a phrase that is easily understandable but due to the presence of Chapter V (i.e. place of supply of goods or services or both) in this Act demands that the common sense understanding be disregarded but the meaning ascribed to the phrase ‘place of supply’ from sections 10 to 14 of this Act be applied. ‘Place of supply’ is a phrase of legal significance whose meaning is to be determined by examining the respective sections in Chapter V and brought to bear while determining nature of supply. For example, manufacture in Maharashtra and supply to a company in Delhi on Ex-Works basis, its place of supply has to be the location of completion of delivery. And in respect of the new supply from Maharashtra to Madhya Pradesh, the place of supply is where the movement terminates for delivery – Madhya Pradesh.

It is therefore important to identify the **location of supplier of goods** and not based on a statutory definition but by inquiring into the facts of a transaction of supply and comparing this with the **place of supply** appointed by the statute in Chapter V. Now, if these two are situated in **different States or UTs or either**, then the nature of supply is declared by section 7 to be in the course of inter-State trade or commerce.

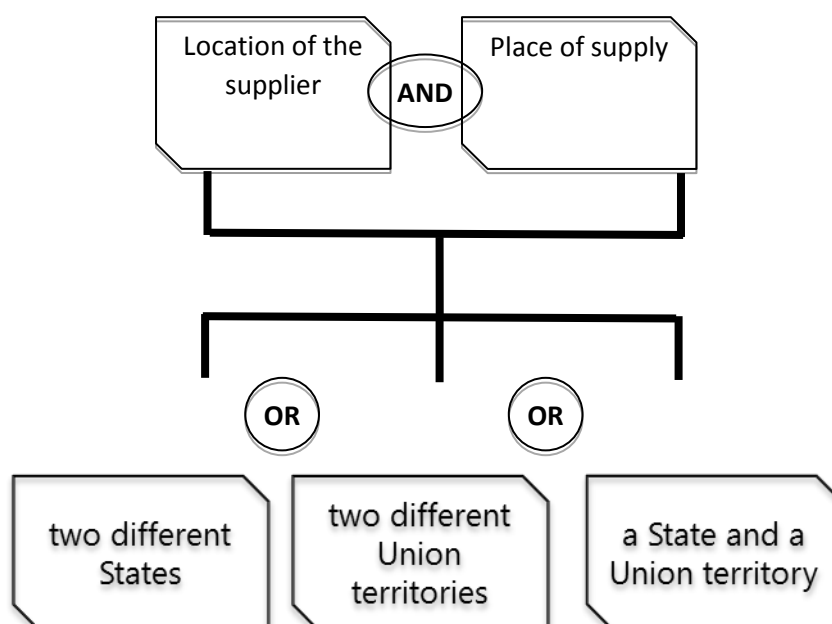

This provision is subject to the provisions of section 10 because any interpretation or application of this section 7 cannot be in derogation of the place of supply dictated by section 10. Section 7 can be correctly interpreted only by identifying the location of supplier of goods based on the physical point where the goods are situated and comparing that with the answer from referring to section 10 regarding place of supply of goods.

With regard to supply of goods that are imported into the territory of India, by legislative override it is declared that if the goods crossed the customs frontiers of India, the supply will always be in the course of inter-State trade or commerce. Reference may be made to the definition of import of goods [section 2(10)] which adverts to the physical movement of goods into India from a place outside India by the active efforts on the part of any person (who may be situated in India or outside India).

The use of the word 'bringing' in section 2(10) excludes naturally and involuntarily occurring phenomena causing the relocation of goods into India from a place outside India. There may be any number of supplies taking place between persons who are incorporated outside India and persons who are incorporated and even registered in India – they will all be transactions of supply in the course of inter-State trade or commerce – till such time the goods cross the customs frontiers of India.

Import of goods

We need to pause here again and examine two kinds of transactions – those that commence outside the territory of India and are concluded also outside territory of India and those that commence outside India but conclude by entering the territory of India. For example, company in Germany supplies goods from Germany to another company in Sri Lanka – this is not a

supply in the course of inter-State trade or commerce because it commences and concludes outside the territory of India. It would be so, even if the goods were supplied by the company in Germany from Germany to a customer incorporated in India if the goods are not 'brought' into India but sold in high seas to yet another company in Singapore. In order for every supply to come within the operation of sub-section 2 to section 7 it requires that the resultant effect of **the supply must cause the goods to enter the territory of India**. This Act does not enjoy extra-territorial jurisdiction and is limited to imposing tax if the goods are imported into the territory of India. In this regard Customs circular issued by the CBEC and an Advance Ruling by the Kerala Authority for Advance Ruling (AAR) is relevant, which is discussed in detail in Section 11 infra.

Further, if goods have been brought into India but have not left the customs frontiers of India, that is, the limits of a customs area, any supplies that are taking place after being brought into India until they cross the customs frontiers of India even though the place of entry into India and the place that comprises the customs frontier may be in the same State will continue to be supply is in the course of inter-State trade or commerce.

For example, goods have been imported from France by a company incorporated and registered in Nasik which have landed at Mumbai port but during their clearance are supplied by the Nasik company to a company in Pune, this supply continues to be in the course of inter-State trade or commerce. Even though the supplier is in Nasik and the recipient is in Pune, since the goods have not yet crossed the customs frontiers of India at the time of supply. This supply comes within the operation of sub-section 2 of section 7. A test that can be applied to determine whether the supply has been concluded before the goods crossed the customs frontiers of India or not crossed the customs frontiers of India is – who has filed a bill of entry in respect of the goods imported as required under the Customs Act. Transactions taking place before filing of bill of entry are termed as "high sea sale" transactions under common trade practice where the original importer sells the goods to a third person before the goods are entered for customs clearance. This supply is covered within definition of inter-State supply. Provisions of sub-section (12) of section 3 of Customs Tariff Act, 1975 in as much as in respect of imported goods provides that all duties, taxes, cess' etc. shall be collected at the time of importation i.e. when the import declarations are filed before the customs authorities for the customs clearance purposes. High sea sale transactions, though regarded as supply in the course of inter-State trade or commerce, are not subject to levy of IGST as the supply takes place before filing of Bill of entry and IGST in case of importation of goods can be levied at the time of filing of Bill of Entry. Hence, IGST on high sea sale(s) transactions of imported goods, whether one or multiple, shall be levied and collected only at the time of importation i.e. when the import declarations are filed before the Customs authorities for the customs clearance purposes for the first time. Further, value addition accruing in each such high sea sale shall form part of the value on which IGST is collected at the time of clearance. The importer (last buyer in the chain) would be required to furnish the entire chain of documents, such as original Invoice, high-seas-sales-contract, details of service charges/ commission paid etc, to establish a link between the first contracted price of the goods and the last transaction.

In the above example, supply by Nasik company to recipient of Pune is high sea sale transaction and is not subject to levy of IGST. When Pune recipient files bill of entry, IGST has to be paid on the assessable value which shall include the margin charged by Nasik supplier also. In fact, after the CGST Amendment Act 2018, all high seas transactions and merchant trading transactions will be covered by Schedule III i.e. activities which are neither supply of goods nor supply of services w.e.f. 01/02/2019

Inter-State supply of services

Continuing with inter-State supply, but in respect of services, it is firstly important to recollect that this provision will apply not only in respect of supply of services but also in respect of transactions involving goods which are treated as supply of services by the fiction in Schedule II of the CGST Act, 2017. The discussion regarding location of supplier of goods and place of supply of goods will be applicable in the context of services but only to a limited extent for the reason that location of supplier of services has been defined in this Act.

The location of supplier of services and the place of supply of services are in two different States or UTs or either, such as supply of services shall be in the course of inter-State trade or commerce. It is interesting to note that inter-State trade is not simply called 'intra-State trade' but is prefixed with 'in the course of'. This prefix is not without reason, because such prefix is missing in relation to intra-State supply. The significance of 'in the course of' is well explained in the decision of State of Bihar Vs Telco Ltd. 27 STC 127 at pg. 148 where the Hon'ble Supreme Court has held that it signifies a series of activities that are all inter-related in an unbroken chain of events so intimately linked to each other that all of them are bound together 'in the course of' such an inter-State trade transaction.

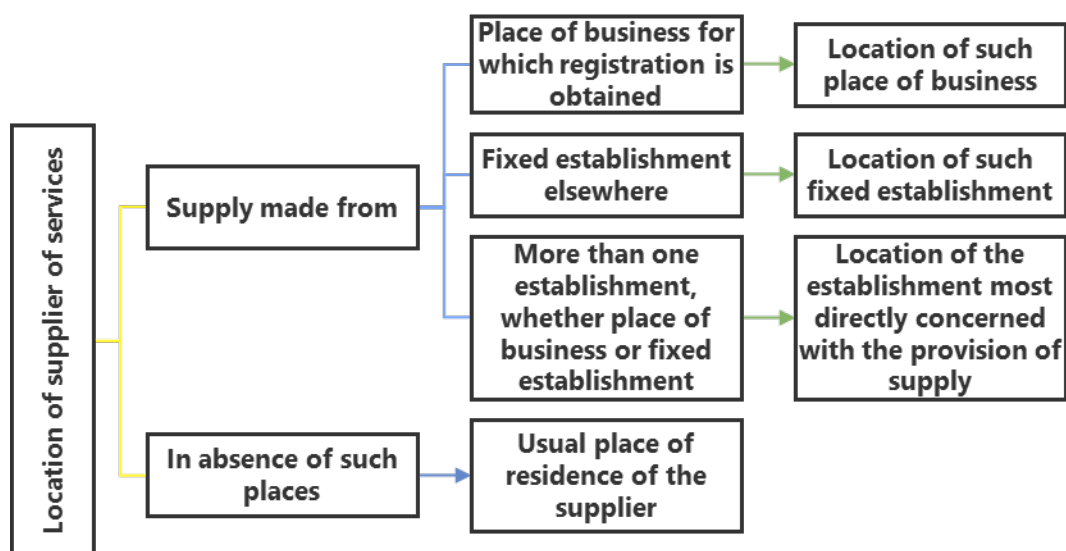

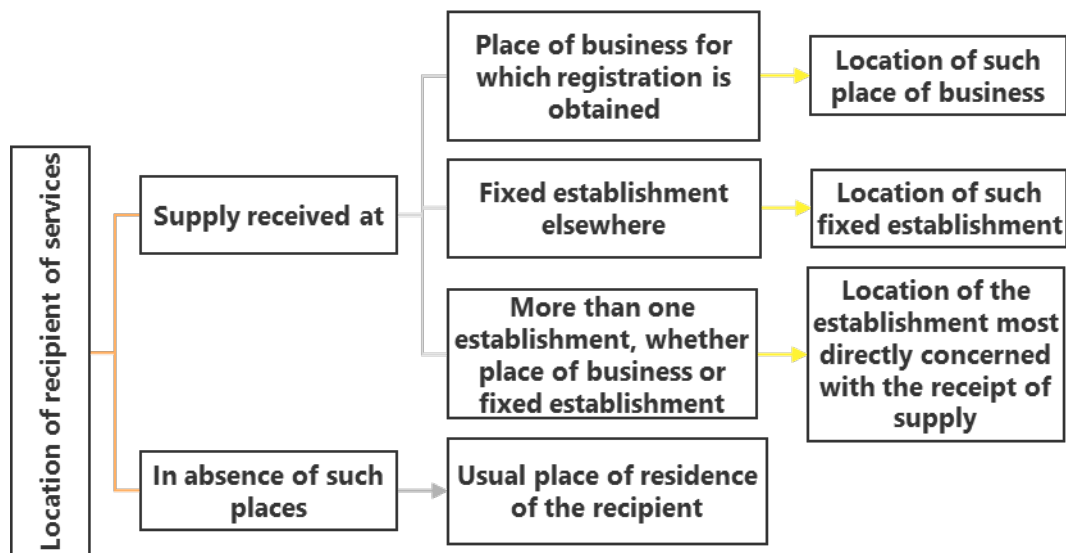

Location of supplier of services is defined to mean 'place of business from where supply is made and duly registered for the purpose'. It also includes other places 'from where' supplies are made being a fixed establishment – a place with sufficient degree of permanence and suitable structure to supply services. And lastly, the usual place of residence of the service provider. It is interesting to note that the location of supplier of services has nothing to do with the business premises 'wherefrom' supply is made.

For example, a company incorporated in Chennai engaged in the business of investment in immovable property and letting them out on rent may have such investments in Chennai and in Hyderabad. By the definition of location of supplier of services being the 'place of business', the company has its place of business where its 'seat of management' is located – Chennai. Accordingly, the location of service provider in relation to the transaction involving renting of immovable property is not where the property let out is situated but the registered office of the company where the management has its seat for decision making. Therefore, in relation to property in Chennai that is let out, it is an intra-State supply because location of supplier of services and place of supply both in Chennai. In respect of its property located in Hyderabad, it is an inter-State supply because the location of supplier of service is in Chennai but the place of supply is Hyderabad. Surely, there is no argument to support the view that in every place where property is located the decision to let out such property is taken in each such location. On the contrary, all decisions are taken where the seat of management is located and therefore, the location of supplier of service remains Chennai wherever the let-out properties may be situated. This view may not be acceptable to all but merits attention.

Special category of inter-State supplies

Fiction in law is no stranger to taxation and GST law indulges in use of fiction without any hesitation. The following categories of supplies of goods or services or both, are treated as being in the course of inter-State trade or commerce:

(a) when the supplier is located in India and the place of supply is outside India

Here, it is extremely important to note that usage of the 'supplier is located' is not to be equated with 'location of supplier'. From the previous discussion, it is learnt that location of supplier of goods is – physical point where the goods are situated under the control of the person wherever incorporated or registered, ready to be supplied. But, the deliberate departure in usage of the same set of words is almost misleading. Supplier is located in India does not refer to location of supplier. Instead, it is a simple question of fact as to where the supplier is located. Please note, that the 'supplier' is none other than the '**one who supplies**' and not his agent or representative or any other person. The question that arises is – what is the GST impact in case the supplier is located outside India and the place of supply is outside India? The Act applies to supplies within the taxable territory and when both – supplier as well as place of supply – being located outside India, the Act does not enjoy any jurisdiction to impose tax even if the recipient is located in India. The destination of consumption being decided by the place of supply provisions and not location of the recipient

2(105) supplier in relation to any goods or services or both, shall mean the person supplying the said goods or services or both and shall include an agent acting as such on behalf of such supplier in relation to the goods or services or both supplied;

(b) where the supply is 'to' or 'by' an SEZ developer or unit

Here, it is important to note that supply to SEZ (developer or unit) is treated as inter-State supply. Supply 'by' SEZ (developer or unit) will also be treated as inter-State supply. Further, the implication of this provision is also that supply by SEZ's *inter se* – one SEZ unit (or developer) to another SEZ unit (or developer) – will also be treated as a supply in the course of inter-State trade or commerce.

Let us take a few examples to illustrate the implications from this provision:

- Taxable person (non-SEZ) located in Jaipur supplying goods to a SEZ unit located in Jodhpur is a supply in the course of inter-State trade or commerce.
- SEZ unit in Kolkata supplying services to another SEZ unit in Kolkata is a supply in the course of inter-State trade or commerce.
- Lease of premises by SEZ developer in Chennai to SEZ unit in that same zone in Chennai will be a supply in the course of inter-State trade or commerce.
- Supply by SEZ unit in Kochi to a non-SEZ in Kochi will be a supply in the course of inter-State trade or commerce.

- Disposal of scrap by a SEZ developer in Mumbai to a scrap dealer in Mumbai (outside the zone) is a supply in the course of inter-State trade or commerce.
- Export of goods by a SEZ unit to a customer in Italy is a supply in the course of inter-State trade or commerce.

(c) Any supply not being an intra-State supply

Here, it is to be considered that any supply that falls outside the scope of intra-State supply will not escape GST, but would be an inter-State supply by virtue of this residual provision in the Act.

Statutory provisions

8. Intra-State Supply

- (1) Subject to the provisions of section 10, supply of goods where the location of the supplier and the place of supply of goods are in the same State or same Union territory shall be treated as intra-State supply:

Provided that the following supply of goods shall not be treated as intra-State supply, namely: –

- (i) supply of goods to or by a Special Economic Zone developer or a Special Economic Zone unit;
- (ii) goods imported into the territory of India till they cross the customs frontiers of India; or
- (iii) supplies made to a tourist referred to in section 15.

- (2) Subject to the provisions of section 12, supply of services where the location of the supplier and the place of supply of services are in the same State or same Union territory shall be treated as intra-State supply:

Provided that the intra-State supply of services shall not include supply of services to or by a Special Economic Zone developer or a Special Economic Zone unit.

Explanation 1 —For the purposes of this Act, where a person has, —

- (i) an establishment in India and any other establishment outside India;
- (ii) an establishment in a State or Union territory and any other establishment outside that State or Union territory; or
- (iii) an establishment in a State or Union territory and any other establishment **being a business vertical**³ registered within that State or Union territory, then such establishments shall be treated as establishments of distinct persons.

Explanation 2 —A person carrying on a business through a branch or an agency or a representational office in any territory shall be treated as having an establishment in that territory.

³ Omitted vide The Integrated Goods And Services Tax (Amendment) Act, 2018 w.e.f 01.02.2019

8.1 Introduction

With the background discussion on inter-State supplies, it would be appropriate to contrast this understanding with a discussion on intra-State supplies.

8.2 Analysis

Intra-State supply of goods

In relation to goods, Section 8 of the IGST Act provides that where the 'location of the supplier' and the 'place of supply' are in the same State or same UT, such a supply will be treated as an intra-State supply. Reference may be had with respect to the discussion on location of supplier of goods in the context of Section 7 of the IGST Act which may be relied upon for the purpose of this discussion. This provision too, is made subject to the provisions of Section 10, that is, regarding the place of supply, and the conclusion reached by applying the said provisions is required to be read into this Section for the purpose of determination of intra-State in nature. The two factors – 'location of supplier' and 'place of supply' – must at the conclusion of a supply, be in the same State or UT. And when it is so, the supply would be an intra-State supply of goods.

For example, a company having its regular registration in Uttar Pradesh has taken a causal registration in Odisha. It has purchased certain goods in Odisha and supplying the same to the customer also in Odisha under two separate transactions of supply, both of them will be intra-State supplies.

Therefore, it is important to bear in mind that the place of incorporation of the supplier in any transaction relating to goods is not relevant as the location of the supplier which has been explained earlier as – physical point where the goods are situated under the control of the distinct person, wherever incorporated or registered, ready to be supplied.

Three exceptions have been carved out in this provision, namely:

- (1) supply 'to' or 'by' a SEZ developer or unit;
- (2) supply involving goods imported into India but not beyond the customs frontiers;
- (3) supply to outbound tourist in terms of Section 15 of the IGST Act.

These three exceptions make it abundantly clear that they have been treated to be an inter-State supply, expressly stated under Section 7. This proviso excludes any opportunity to question the probable intra-State nature of the said supply. As discussed in the various examples, even though the movement of goods may be within the same State, due to the deeming fiction imposed in Section 7 – these supplies are treated as supplies in the course of inter-State trade or commerce – and cannot be disturbed by Section 8. The express exclusion is evidence of a suspect inclusion – with this proviso, there is no question of the intra-State nature of the supplies listed.

Please note that the supplies are not three specific supplies but three classes of supplies. Examples of supply to or by a SEZ developer or unit has already been discussed in detail earlier the same may be referred. Supply involving goods imported into India also been discussed and the same may be referred. For examples, regarding supplied to tourist, kindly refer discussion under Section 15.

Intra-State supply of services

With regard to supply of service, if the twin factors – location of supplier of services' and 'place of supply of services' – are in the same State or UT, then such supply will be treated as intra-State supply. Location of supplier of services has been defined in the Act to mean 'place of business from where supply is made and duly registered for the purpose'. It also includes other places and reference may be had to the discussion in respect of inter-State supply of services for the implications of this definition.

To provide some additional illustration, consider audit services being provided by a Chartered Accountant located in Delhi to a company in Delhi. For the purpose of the audit, the Chartered Accountant visits the company's factory located in Noida. Here, although the Chartered Accountant is physically moving to Noida, he is not supplying the audit services from Noida. Here, the transaction will be an intra-State supply from Delhi to Delhi. Please refer to more detailed discussion under Section 12.

Further, here too we find caution exercised in expressly excluding supply of services 'to' or 'by' SEZ developer or unit from the scope of intra-State supply of services. The two explanations provided are significant as the concept of distinct persons in Section 25(4) and (5) of the CGST Act is further clarified in stating that the following will also be distinct persons, namely:

- establishment in India and an establishment outside India;
- establishment in a State or UT and an establishment outside that State or UT;
- establishment in a State or UT and any other establishment (registered separately) in the same State or UT.

2(15) location of supplier of services means –

- (a) where a supply is made from a place of business for which the registration has been obtained, the location of such place of business;
- (b) where a supply is made from a place other than the place of business for which registration has been obtained (a fixed establishment elsewhere), the location of such fixed establishment;
- (c) where a supply is made from more than one establishment, whether the place of business or fixed establishment, the location of the establishment most directly concerned with the provision of the supply; and
- (d) in the absence of such places, the location of the usual place of residence of the supplier;

Please note that the term 'establishment' may be interpreted as being similar to 'fixed establishment' which is defined in this Act in identical manner with the definition in section 2(50) of CGST Act. It refers to it being 'a place with sufficient degree of permanence and suitable structure to supply services or to receive and use the services'.

Section 2(7) fixed establishment means a place (other than the registered place of business) which is characterised by a sufficient degree of permanence and suitable structure in terms of human and technical resources to supply services or to receive and use services for its own needs;

Place of supply concept – goods or services

Location of Supplier	Place of Supply	Whether inter-State/ intra-State
Kerala	Bihar	Inter-State (IGST)
Puducherry	Puducherry	Intra-State (CGST + Puducherry GST)
Daman and Diu	Daman and Diu	Intra-State (CGST + UTGST)
Chandigarh	Punjab	Inter-State (IGST)
Chandigarh	Daman and Diu	Inter-State (IGST)
Goa	Goa	Intra-State (CGST + Goa GST)
Karnataka (SEZ)	Karnataka (non-SEZ)	Inter-State (IGST)

8.3 Comparative Review

There is no such proposition in the erstwhile laws as the concept of supply is unique to our tax system and considered as a 'taxable event' for the first time in indirect tax regime. The provisions of Section 7 and 8 have to be read alongside Sections 10 and 12 and whenever a conflict arises between the said provisions, Section 7, or as the case may be, Section 8 has to make way for section 10/ 12, which is signified by usage of the words "subject to the provisions of sections 10/ 12".

However, broadly this can be compared with the provisions of CST Act, 1956 which provides for determining when a sale will be an inter-State sale or when a sale in outside the State.

8.4 Issues and concerns

1. By virtue of Section 7(5) of the IGST Act, all supplies made by or to SEZ units or developers are treated as inter-State supplies. So to say, a small tea vendor (kinara shop) supplying evening beverages to an SEZ unit, or an inward supply of office stationery from a small stationery supplier, by an SEZ unit, will be regarded as inter-State supplies. In this regard, it is important to note that the GST Law mandates registration, regardless of the turnover, where a supplier is engaged in effecting inter-State taxable supplies. Although the inclusion of such transactions was, perhaps, not the intent of the legislature, it is noted that there is no relaxation provided in this regard, in respect of mandatory registration in respect of supply of goods.

2. Evidently, the law provides for the definition of the phrase 'location of the supplier of services' and turns a blind eye to the phrase 'location of the supplier of goods'. Accordingly, the debate arises as to what constitutes the location of the supplier, in respect of goods. Drawing inference from Section 22(1) of the CGST Act, every supplier shall be liable to be registered in the State or UT from where he effects taxable supplies, subject to crossing the aggregate turnover threshold limits. This means that, while a supplier may be registered in one State, and stocks his goods in another State for any reason, shall be required to take a registration in the second State as well, when he effects a supply of such goods from the State. Merely because the supplier has not obtained a registration in the second State does not alter the fact that the supply is in fact, effected from a State other than the State in which he has obtained registration. Therefore, the location of the supplier is regarded as the location of the goods at the time of removal of such goods for supply.
3. The meaning of the term 'fixed establishment' and its usage have not been adequately justified in the Statute. By definition, a fixed establishment is one, other than a registered place of business, and by such definition, it is built to supply services or receive services. However, it is also noted that a supplier is liable to obtain registration from every place (State or UT) from where he effects any taxable supplies, as explained supra. On a combined reading of the two, there is no possibility for one to operate through a fixed establishment in India, for the supply of services, given that a fixed establishment is not a registered place of business. Clarity is awaited in this regard.

Statutory provisions

<p>9. Supplies in Territorial Waters</p> <p><i>Notwithstanding anything contained in this Act, —</i></p> <p>(a) <i>where the location of the supplier is in the territorial waters, the location of such supplier; or</i></p> <p>(b) <i>where the place of supply is in the territorial waters, the place of supply,</i></p> <p><i>shall, for the purposes of this Act, be deemed to be in the coastal State or Union territory where the nearest point of the appropriate baseline is located.</i></p>
--

Related Provisions of the Statute

Statute	Section / Rule	Description
IGST	Section 2(5)	Definition of export of goods
IGST	Section 2(6)	Definition of export of service
IGST	Section 2(10)	Definition of import of goods
IGST	Section 2(11)	Definition of import of service
IGST	Section 2(15)	Definition of location of supplier of service

CGST	Section 2(56)	Definition of India
CGST	Section 2(103)	Definition of State
CGST	Section 2(114)	Definition of Union Territory
IGST	Section 7	Meaning of inter-State supplies
IGST	Section 8	Meaning of intra-State supplies
IGST	Section 10	Place of supply of goods other than supply of goods imported into, or exported from India
IGST	Section 11	Place of supply of goods imported into, or exported from India
IGST	Section 12	Place of supply of services where location of supplier and recipient is in India
IGST	Section 13	Place of supply of services where location of supplier or location of recipient is outside India
IGST	Section 5	Levy and collection of tax
CGST	Section 9	Levy and collection of tax
CGST	Section 25	Registration

9.1 Introduction

GST being a destination-based consumption tax (discussed in greater detail in section 10), the supply may at times take place in the territorial waters of India, including cases where a supplier is required to travel into the territorial waters in order to supply goods or services. While the nature of supply in these cases may be inter-State supplies (in terms of Section 7(5)(c) of the IGST Act – residuary clause), by virtue of this Section, the law provides a deeming fiction to reinstate the steps to be applied in Sections 7 and 8 by artificially specifying the location of ‘location of supplier’ and the location of ‘place of supply’. For this reason, clear provisions are laid down as to where on the land mass of India, the actual location will be linked to. Please note, the statute uses the expression ‘deemed to be’ which would supply an artificial meaning. Also, this provision does not seek to violate exclusive jurisdiction of the Union on matters of territorial waters but merely establishes a link to the land mass of India to overcome judicial intervention or assumptions by industry.

9.2 Analysis

The provision identifies two facts that have been discussed at length in the context of section 7 and 8, namely:

- Location of supplier of goods or services or both
- Place of supply of goods or services or both

By applying the provisions of Sections 10 and 12, if it is established that the 'place of supply' or 'the location of the supplier' is found to be in the territorial waters and not on the land mass, an ambiguity could arise as to where the supplier is required to be registered, or which State the tax on the supply should be apportioned to. To address these situations, the statute lays down, vide this deeming fiction, that such locations – 'supplier' or 'place of supply' – will be the most proximate State or UT.

For example, consider a case where a ship is moored off the coast of Kochi (Kerala) needs a replacement of a crucial part, and such replacement is carried out along with the supply of the part by a Company located in Karnataka for the shipping company from United Kingdom. In this case, the place of supply of the part, being the location of the ship (as determined in terms of Section 10) will create doubt about the applicability of GST. By virtue of the provisions of Section 9, it is clear that the place of supply will not be the *territorial waters* but would be Kochi itself. With this doubt having been resolved, it would be an inter-State taxable supply effected by the Company in Karnataka *albeit* to the UK Company, while the State tax would be apportioned to the Kerala Government.

The non-obstante clause at the beginning of this Section is important to overcome any alternative interpretations that may be attempted by reading other provisions of the Act.

9.3 Comparative Review

Under the erstwhile tax laws, Central Excise is on 'manufacture of goods', VAT/ CST is on 'sale of goods' and Service tax is on 'provision of service'. Unlike different incidences, under the GST law, it is 'supply' which would be the taxable event. Under the erstwhile law, e.g.: while stock transfers are liable to Central Excise (if they are removed from the factory), it would not be liable to VAT/ CST. However, under the GST law, it would be taxable as a 'supply'. Further, free supplies would be liable to excise duty, while under the VAT laws, free supplies would require reversal of input tax credit; under the GST law, the treatment would be similar to the erstwhile VAT laws, where the supplies are made without any consideration (monetary/ otherwise).

Under the erstwhile laws, there are multiple transactions which apparently qualified as both 'sale of goods' as well as 'provision of services'. E.g.: license of software, providing a right to use a brand name, etc. Unlike this situation, GST clarifies as to whether a transaction would qualify as a 'supply of goods' or as 'supply of services'. A transaction would either qualify as goods or as services, under the GST law. Even in respect of composite contracts, it has been clarified under the GST law (Schedule II of the Act, concept of composite supply and mixed supply).

The payment of VAT in the hands of the purchaser (registered dealer) on purchase of goods from an unregistered dealer and the circumstances where the Service Tax is payable under the reverse charge mechanism in respect of say, import of services, sponsorship services etc. are comparable to the 'reverse charge mechanism' prescribed herein. However, the concept of

partial reverse charge/ joint charge has not continued in the GST regime, viz., every supply will be liable to forward charge/ reverse charge, wholly. Further, the concept of reverse charge only existed in relation to services under Service tax as Central Excise did not provide for payment of duty under reverse charge on goods. However, the VAT laws of most states did provide for payment of tax under reverse charge on goods purchases effected from unregistered dealers in specified circumstances. The GST law, however, permits the supply of both, goods as well as services, to be subjected to reverse charge.

9.4 Issues and concerns

1. While it is clear that the location on the landmass that is most proximate to the location in the territorial waters will be the deemed location of the supplier / place of supply, as the case may be, it may be noted that the GST Law does not prescribe the methodology for determining the distance between the location in the territorial waters and the landmass. Therefore, the basis adopted for determining the nautical distance computed to determine the territorial waters is to be adopted to determine the distance.
2. There could be an exceptional case wherein the location in the territorial waters (being the location of the supplier / place of supply) is equally proximate from two different States / UTs. Such a scenario has not been addressed in this Section and can only be dealt with as and when it is brought to light.

Chapter 5

Place of Supply of Goods or Services or Both

10. Place of supply of goods other than supply of goods imported into, or exported from India
11. Place of supply of goods imported into, or exported from India
12. Place of supply of services where location of supplier and recipient is in India
13. Place of supply of services where location of supplier or location of recipient is outside India
14. Special provision for payment of tax by a supplier of online information and database access or retrieval services

Statutory provisions

- 10. Place of supply of goods, other than supply of goods imported into, or exported from India**
- (1) *The place of supply of goods, other than supply of goods imported into, or exported from India, shall be as under, —*
- (a) *where the supply involves movement of goods, whether by the supplier or the recipient or by any other person, the place of supply of such goods shall be the location of the goods at the time at which the movement of goods terminates for delivery to the recipient;*
 - (b) *where the goods are delivered by the supplier to a recipient or any other person on the direction of a third person, whether acting as an agent or otherwise, before or during movement of goods, either by way of transfer of documents of title to the goods or otherwise, it shall be deemed that the said third person has received the goods and the place of supply of such goods shall be the principal place of business of such person;*
 - (c) *where the supply does not involve movement of goods, whether by the supplier or the recipient, the place of supply shall be the location of such goods at the time of the delivery to the recipient;*
 - (d) *where the goods are assembled, or installed at site, the place of supply shall be the place of such installation or assembly;*

<p>(e) where the goods are supplied on board a conveyance, including a vessel, an aircraft, a train or a motor vehicle, the place of supply shall be the location at which such goods are taken on board.</p> <p>(2) Where the place of supply of goods cannot be determined, the place of supply shall be determined in such manner as may be prescribed.</p>
--

Related Provisions of the Statute

Statute	Section / Rule	Description
CGST	Section 2(56)	Definition of India
CGST	Section 2(93)	Definition of recipient
CGST	Section 9	Levy and collection of tax
IGST	Section 2(5)	Definition of export of goods
IGST	Section 2(10)	Definition of import of goods
IGST	Section 5	Levy and collection of tax
IGST	Section 7	Meaning of inter-State supplies
IGST	Section 8	Meaning of intra-State supplies
IGST	Section 11	Place of supply of goods imported into, or exported from India
IGST	Section 12	Place of supply of services where location of supplier and recipient is in India
IGST	Section 13	Place of supply of services where location of supplier or location of recipient is outside India

10.1 Introduction

Place of supply is important to determine the kind of tax that is to be charged. When the location of supplier and the place of supply are in two different States, then it will be an inter-State supply and IGST would be chargeable. And when they are in the same State, then it will be an intra-State supply and CGST/ SGST would be chargeable. 'Place of supply' is not a phrase of common understanding, it is a legal term and as in the cases of all legal terms, their common understanding must not be applied but the meaning assigned to them in the law must be followed. Place of supply, similar to time of supply, is that which the legislature has appointed.

GST is understood as a 'destination-based consumption tax' but there is no provision that declares this fact. This missing declaration is more than adequately supplied by the principle

being embodied in the provisions of 'place of supply'. It is here that we find that the destination principle of GST is fully captured. The law makers have declared, in each case of supply, its destination of supply.

10.2 Analysis

(a) Place of Supply – Supplies within India

Place of supply of goods, where the supplier and the recipient are both located within India, will be determined in accordance with section 10 of the IGST Act. The phrase 'location of supplier of goods' has not been defined in the IGST Act and this is deliberate due to the reason that location of the supplier of goods can be easily tracked whereas location of supplier of services, which has been defined under section 2(15) of the IGST Act. Two very important phrases are relevant, namely:

— Location of supplier – the word 'location' in this phrase refers to the site or premises (geographical point) where the supplier is situated with the goods in his control ready to be supplied or in other words it is the physical point where the goods are situated under the control of the person wherever incorporated or registered, ready to be supplied.

However, in case where goods are sent by the Principal to a job worker and the goods are subsequently supplied by the Principal from such job worker's place directly to the premises of the Principal's customer, a view can be taken that the 'location of supplier' would be the location of the Principal from where the goods were originally sent.

Though there is much doubt if this view is really in harmony with the provisions of the law, which require that the Principal declares the location of the job worker as his additional place of business in order to effect supplies directly from the job worker's location (and an additional place of business ought to be within the same State for which the registration has been obtained). Therefore, in the alternate view, the Principal would be required to obtain a separate registration in the State in which the job worker is located, in order to effect taxable supplies from the job worker's premises;

— Place of supply of goods – this is a legal phrase which the section decides to be the site or premises (geographical point) as its 'place of supply'.

Place of supply in each case is discussed below:

(a) **Where 'supply involves movement'**, the place of supply will be the place where the goods are located at the time at which the movement terminates for delivery to the recipient.

✓ The location of the goods is a question of fact to be ascertained by observing the journey that the goods supplied make from their origin from supplier and terminating with recipient.

- ✓ This movement, however, can be by the supplier or by the recipient after having disclosed the destination of their movement or journey.
- ✓ Movement 'terminates for delivery' requires a brief understanding about the manner of concluding delivery. Delivery 'the mode and the time' is the unilateral choice of the recipient and the supplier has no authority to decide 'how' and 'when' he will deliver the goods to the recipient. It is easy to determine in a contract for supply where it records this 'choice' of the recipient regarding the mode and time of delivery. The supplier is always duty-bound to deliver in exactly the same way 'manner and timing' which the recipient dictates. In fact the supplier continues to be obligated until delivery is completed in the way it is stated by the recipient. In other words, delivery is not complete if there is any deviation in either the manner or the timing as compared to that dictated by the recipient. When the delivery is to the satisfaction of the recipient, then the supplier is released from his obligation. Therefore, the additional question of fact to be determined is the mode and time of delivery dictated by the recipient and whether the same has been complied with to the satisfaction of the recipient.

Illustrations:

Section 10(1) (a): Supply involves movement of goods

Particulars	Supplier's factory from where goods are removed	Termination of movement for delivery	Place of supply	Tax Payable
Movement of goods by the supplier (goods dispatched by supplier)	Orissa	Assam	Assam	IGST payable at Orissa
<i>[Section 10(1)(a) read with section 2(96)(a) of CGST Act]</i>	Orissa	Orissa	Orissa	CGST/ SGST payable at Orissa
Movement of goods by the recipient (goods collected by recipient)	Kerala	Goa	Goa	IGST payable at Kerala
<i>[Section 10(1)(a) read with section 2(96)(b) of CGST Act]</i>	Kerala	Kerala	Kerala	CGST/ SGST payable at Kerala

(b) **Where goods are delivered by the supplier to the recipient but at the instruction of a third person**, then the place of supply will be the principal place of business of such third person and not of the actual recipient.

- ✓ It is important to identify the two supplies involved – by supplier to third person and by third person to recipient. This provision deals only with the first limb of supply, that is, supply by supplier to third person.
- ✓ The question that arises is – the locus or authority of the third person to issue instructions to the supplier regarding its delivery. Even though the definition in section 2(93) refers to recipient as the ‘payer of the consideration’, in this provision, recipient is the one who actually collects the goods. And the third person is the one who enjoys privity with the supplier to be able to direct him to deliver the goods. This is a case of constructive delivery to the third person, therefore, the third person turn out to be the recipient in this case.

Now, the place of supply will not be dependent on whether the movement of goods is from one State to another (if the supplier and recipient are in two different States) but as declared by the section to be dependent on the principal place of business of such third person (i.e., the person providing instructions to the supplier where the delivery should take place).

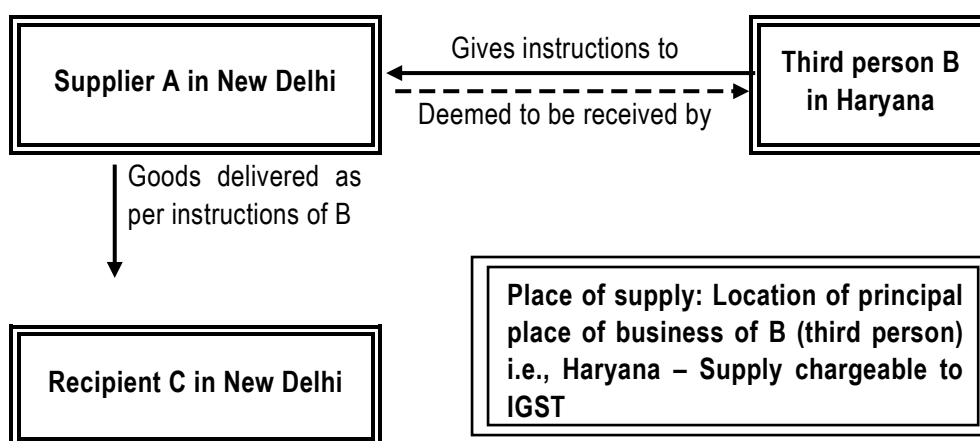

Illustrations:

Section 10(1)(b): Supply involves movement of goods, and delivered to a person on the instruction of a third person

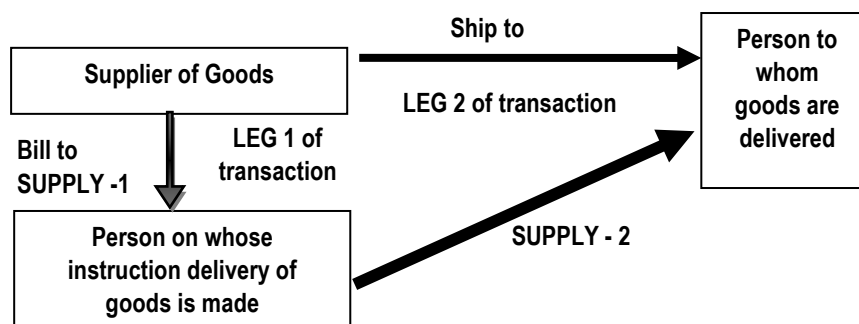

Leg 1: Supply from the supplier of goods (Seeta) to the person to whom the goods are delivered (Ram) on the instruction of a third person (Lakshman) – *Place of supply shall be the principal place of business of the person on whose instruction goods are delivered to the receiver of goods, being the principal place of business of Lakshman* [Section 10(1)(b)]:

Case	Location of Supplier - Seeta	Place of delivery of goods - Office of Ram	Principal place of business of Lakshman who instructed delivery to Ram	Place of supply for Seeta	Type of tax payable by Seeta
1	Ahmedabad	Ahmedabad	Amritsar	Amritsar	IGST at Gujarat
2	Ahmedabad	Amritsar	Amritsar	Amritsar	IGST at Gujarat
3	Ahmedabad	Bangalore	Bangalore	Bangalore	IGST at Gujarat
4	Ahmedabad	Chandigarh	Ahmedabad	Ahmedabad	CGST + Gujarat GST at Gujarat

Leg 2: Deemed supply of goods by the person on whose instruction (Lakshman) the goods were delivered by the original supplier (Seeta) to the receiver of goods (Ram) – *Place of supply shall be the location of the goods at the time of delivery to the recipient* [Section 10(1)(a)]:

Case	Location of Supplier - Seeta	Principal place of business of Lakshman who instructed delivery to Ram	Place of delivery of goods - Office of Ram	Place of supply for Lakshman	Type of tax payable by Lakshman
1	Ahmedabad	Amritsar	Ahmedabad	Ahmedabad	IGST at Punjab
2	Ahmedabad	Amritsar	Amritsar	Amritsar	CGST + Punjab GST at Punjab
3	Ahmedabad	Bangalore	Bangalore	Bangalore	CGST + Karnataka GST at Karnataka
4	Ahmedabad	Ahmedabad	Chandigarh	Chandigarh	IGST at Gujarat

(c) **Where the supply does not involve movement of goods**, the place of supply will be the location of the goods at the time of its delivery to the recipient.

- ✓ It is not a case where there is difficulty in movement of the goods, but a case where the supply contemplates that the goods ought not to move and when their delivery to the recipient will stand complete.
- ✓ For example, a generator that is bolted to the concrete floor in the basement of a building purchased by the tenant and being left behind at the time of terminating the tenancy, the supply of the generator by the tenant to the landlord for an agreed price is a case of 'supply that does not involve movement of the goods'. In such cases, the place of supply will be where the generator stands bolted to the concrete floor and without requiring any movement. The landlord (recipient) confirms satisfactory completion of delivery.

Another example would be a case where the job worker develops a mould for the production of goods for the principal and retains the mould in his place itself for production of goods. The mould developed by the job worker is sold to the principal but the same is retained by the job worker without causing the movement of mould from job worker premises to principal premises. In this case, the place of supply would be job worker premises.

- ✓ This provision comes into operation only when its applicability is established based on the facts involved in the supply, that is, they do not involve movement.

Illustrations:

Section 10(1) (c): Supply does not involve movement of goods

Particulars	Location of supplier	Location of recipient	Location of goods at the time of delivery	Place of supply	Tax Payable
Sale of pre-installed DG Set	Delhi	Bhopal	Bhopal	Bhopal	IGST payable at Delhi
Manufacture of moulds by job-worker (supplier), sold to the Principal, but retained in job worker's premises	Tamil Nadu	Kerala	Tamil Nadu	Tamil Nadu	CGST + Tamil Nadu GST payable at Tamil Nadu

(d) **Where the goods are assembled or installed at site**, the place of supply will be the location of such installation or assembly.

- ✓ It is important to note that assembly or installation as referred to in this clause is not a 'works contract', which has been classified by law as a supply of services (in Paragraph 6(a) of Schedule II to the CGST Act, 2017) – please note that the concept of works contract would arise only in respect of services, for which the place of supply is determined under section 12 and section 13 of the IGST Act, 2017.
- ✓ The supply addressed in this provision refers to only a supply of goods, being a composite supply of goods along with some services, or a mixed supply treated as a supply of goods in terms of sections, 2(30), 2(74) and 8 of the CGST Act. In other words, supply from the place of their origin to the site 'for' assembly or installation is subsumed within this provision and merged with the supply to the recipient by virtue of such assembly or installation.
- ✓ This provision appoints the place of supply based on the final act of assembly or installation. There is no requirement to vivisection the entire composite supply of goods (not being works contracts) that is a supply-cum-installation into a supply-plus-installation. If such vivisection were to be done, then in every instance of supply-cum-installation, the supplier will become a 'casual taxable person' in the State where the assembly or installation is required. In other words, when the goods are located in a State (under the control of the supplier which is not registered in that State) and then makes an outward supply directly from where the goods are located, that location becomes the 'place of business' (being the place of storage of goods) of the supplier, making him a casual taxable person in that State.

Illustrations:

Section 10(1) (d): Supply of goods assembled/ installed at site

Particulars	Location of supplier	Registered office of recipient	Installation / Assembly Site	Place of supply	Tax Payable
Installation of weigh bridge	Delhi	Bhopal	Bhopal	Bhopal	IGST payable at Delhi
Servers supplied and installed at an office	Karnataka	Goa	Karnataka	Karnataka	CGST + Karnataka GST payable at Karnataka
Supply of work-stations	Gujarat	Gujarat	Kerala	Kerala	IGST payable at Gujarat

(e) **Where goods are supplied on-board a conveyance**, the place of supply will be the location at which the goods are taken on-board.

- ✓ Such transactions also cover two supplies – first being the supply of goods ‘to’ the operator of the conveyance, and second being the supply of such goods as goods or as services, ‘by’ the operator to the passenger (or any other person), during the journey ‘in’ the conveyance.
- ✓ The place of supply covered under this clause is in respect of the second limb, and particularly for the supply of goods by the operator of the conveyance during its journey to the passengers. The supply of goods being food or beverages on board a conveyance would be outside the scope of this clause, given that such supply is treated as a composite supply of services in terms of Paragraph 6(b) of Schedule II to the CGST Act, 2017. Notification No. 13/ 2018-Central Tax (Rate), dated 26-Jul-2018 states that supply of food in train/ platform would be taxable @5% *pari materia* with restaurant services. However clarity is awaited with respect to the place of supply of such services supplied by IRCTC is to be considered as restaurant services [10(4)] or goods supplied on board [10(1)(e)] classified under However, supply of goods like sale of gift items etc. would be covered under this clause.
- ✓ The term ‘conveyance’ includes vessel, aircraft, train or motor vehicle as defined under section 2(34) of the CGST Act.
- ✓ The place of supply in respect of first limb of supply will continue to be determined by other provisions of this Chapter and only the second limb of supply ‘on-board the conveyance’, being a supply of goods, will be determined by this clause.

Illustrations:

Section 10(1) (e): Goods supplied on board a conveyance

Particulars	Location of supplier	Loading of goods	Passenger boards at	Place of supply	Tax Payable
Supply of gift items on a flight	Punjab	Punjab	Delhi	Punjab	CGST + Punjab GST payable at Punjab
Sale of Power bank during the journey	Pune	Goa	Hyderabad	Goa	IGST payable at Maharashtra
Sale of sun-glasses on a ship	Bangalore	Chennai	Cochin	Chennai	IGST payable at Karnataka

- (f) **Residuary provision:** Where none of the foregoing provisions are applicable to determine the place of supply in case of a supply of goods, the Central Government may prescribe rules regarding the manner of its determination. Please ensure that before taking recourse to this residuary provision, it must be demonstrated that the supply is one which cannot be covered by any of the clauses (a) to (e) of section 10(1) .

10.3 Issues and concerns

Consider a case of delivery ex-factory. In such a case, a question may arise as to whether the supply involves movement of goods. However, considering that clause (a) specifies that the movement may be by the supplier or the recipient or any other person, it can be inferred that even a supply with an ex-factory delivery would be considered to be a supply involving movement of goods. The law does not provide the meaning of the phrase “terminates for delivery”. Delivery may be physical, constructive, implied or in any other form. A plain reading of this clause suggests that the delivery is completed ex-factory, and accordingly, ex-factory supplies would always be intra-State supplies (unless the supplier or recipient is an SEZ).

However, on making thorough study of the law, i.e. section 10(1)(a); section 2(2) which defines “address of delivery” as the address of the recipient of goods or services or both indicated on the tax invoice issued by a registered person for delivery of such goods or services or both; section 2(3) defines “address on record” as the address of the recipient as available in the records of the supplier; section 2(93) defines “recipient” of supply of goods or services or both; and section 2(96) defines “removal” in relation to goods, suggest that in case of ex-factory sale or counter-sale, the delivery of goods done by the supplier or taken by the recipient would terminate at the registered place or address on record mentioned in the tax invoice. As such, it can be inferred that if the delivery of goods is taken ex-factory or on

counter sale by the recipient such supply would be chargeable to tax based on the address mentioned in the tax invoice.

An alternative view is possible – it may be noted that the delivery for the purpose of the contract law and delivery indicated by this clause may be different. For the purpose of the GST law, a supply is effected on removal of goods for delivery, whereas for contract law, the supply may be understood (in terms of an agreement) to be completed only on acceptance of such goods by the recipient. Similarly, while the risks and rewards pertaining to the goods being supplied may pass at the factory gate, the movement for delivery of such goods may stand terminated only at the premises of the recipient, considering that the movement is undertaken by the recipient for delivery at his own premises.

Statutory provisions

11. Place of supply of goods imported into, or exported from India

The place of supply of goods, —

- (a) *imported into India shall be the location of the importer;*
- (b) *exported from India shall be the location outside India.*

Relevant circulars, notifications, clarifications issued by Government:

3. Circular No. 33/ 2017-Customs, dated 01.08.2017 clarifying the applicability of IGST on High Sea Sales
4. Circular No. 3/1/2018-GST, dated 25.05.2018 regarding applicability of IGST on goods supplied while being deposited in customs bonded warehouse
5. Circular No. & Date: 91/10/2019-GST Dated 18th February, 2019 Supply of Warehoused goods before clearance from 01st July 2017- 31st march 2018.

During the period from 1st of July, 2017 to 31st of March, 2018 (hereinafter referred to as the “said period”), IGST was applicable on the said transaction but due to non-availability of the facility on the common portal, suppliers have reported such supplies as intra-State supplies and discharged central tax and state tax on such supplies instead of integrated tax. Hence to provide one time exception, it has been decided that suppliers who have paid central tax and state tax on such supplies, during the said period, would be deemed to have complied with the provisions of law as far as payment of tax on such supplies is concerned as long as the amount of tax paid as central tax and state tax is equal to the due amount of integrated tax on such supplies

Related Provisions of the Statute:

Statute	Section / Rule	Description
CGST	Section 2(56)	Definition of India
IGST	Section 2(5)	Definition of export of goods
IGST	Section 2(10)	Definition of import of goods
IGST	Section 5	Levy and collection of tax
IGST	Section 7	Meaning of inter-State supplies
IGST	Section 10	Place of supply of goods other than goods imported into, or exported from India
IGST	Section 12	Place of supply of services where location of supplier and recipient is in India
IGST	Section 13	Place of supply of services where location of supplier or location of recipient is outside India
IGST	Section 16	Zero-rated supplies

11.1 Analysis**Place of Supply – Supplies outside India**

Place of supply of goods where the goods are imported into or exported from India will be determined in accordance with section 11 of the IGST Act. Export of goods is defined in section 2(5) of the IGST Act and import of goods is defined in section 2(10) of the IGST Act. With these definitions, which are with reference to the movement of goods and not the location of the supplier or recipient, in this case, the place of supply will be:

2(5) “export of goods” with its grammatical variations and cognate expressions, means taking goods out of India to a place outside India;

2(10) “import of goods” with its grammatical variations and cognate expressions, means bringing goods into India from a place outside India;

- (a) In the case of import of goods, the location of the importer and
- (b) In the case of export of goods, the location outside India where the goods are exported.

While payment in convertible foreign exchange is for services including transactions involving goods treated as services, the same is not a criterion for determining whether a supply of goods is an export of goods or import of goods. Transactions of merchanting trade – where the goods are procured from one country and are directly dispatched without their entering into India, will not be a supply in the ‘taxable territory’ of India. Such transactions will be included for a financial effect in the books of accounts, without invoking the levy provisions

under the GST laws. Another form of international supply commonly known as High Sea Sales (known as 'HSS') is also a transaction that transpires outside the taxable territory and accordingly, does not attract the incidence of GST. Re-import of export goods will however, be liable to GST. It is interesting to note that 'location of supplier or recipient' are not relevant in this section.

'HSS' of imported goods is a term used to denote a transaction whereby the original importer sells the goods to a third person before the goods are entered for customs clearance. Since all transactions entered within the territory of India for sale and purchase of goods is taxable under GST, there were doubts on the levy of GST on 'HSS'. More so, when such 'HSS' were categorised as inter-State supplies. Accordingly, the Government clarified the position of levy of GST on 'HSS' vide *Circular No. 33/ 2017-Cus dated 01.08.2017* – that IGST on 'HSS' transactions of imported goods, whether one or multiple, shall be levied and collected only at the time of importation i.e. when the import declarations are filed before the Customs authorities for the customs clearance purposes for the first time. In other words, the buyer of 'HSS' shall be disposing IGST on such imports and as part of Customs. Further, value addition accruing in each such 'HSS' shall form part of the value on which IGST is collected at the time of clearance i.e. buyer shall pay IGST on the final purchase value as per last High Sea transaction envisaging all margins earned by all persons who made 'HSS' of such goods.

Taxation of 'HSS': The Advance Ruling by the Kerala Authority for Advance Ruling (AAR) in the case of *M/s. Synthite Industries Ltd. TS-111-AAR-2018* is relevant to note:

The impact of GST on 'HSS' may be aptly summarised through the four issues that were raised before the AAR for determination by the Authority:

1. Whether GST is payable on goods procured from China, but are not brought into India?
2. Whether GST is payable on the sale of goods to the company in USA, where goods sold are shipped directly from China to USA without entering India?
3. Whether GST would be applicable on goods procured from China (not against any specific export order) and the same is directly shipped to a warehouse located in Netherlands?
4. Whether GST would be applicable on sales effected directly from the warehouse in Netherlands to the customers located in that country?

The AAR observed that goods are liable to IGST only when they are imported into India and the IGST is payable at the time of importation of goods into India. All the above queries were answered in the negative as the goods were never imported into India and thus, not liable to GST.

Input Tax Credit reversal of goods sold on 'HSS': The Advance Ruling by the Maharashtra Authority for Advance Ruling (AAR) in the case of *BASF India Ltd. 2018 (7) TMI 53* held that

the goods sold on 'HSS' basis being non-taxable supply as per section 2(78) of the CGST Act and being exempt supply as per section 2(47) of the CGST Act, the input tax credit to the extent of inputs, input services and common input services would be required to be reversed by the applicant as per section 17 of the CGST Act.

However, the law makers turned prudent to redress such regressive provision in law and suitably has brought in an amendment (mentioned hereinafter) in Schedule III to bring in such supplies outside the purview of exempt supplies and consequently such reversal of ITC may not be warranted even in those cases which pertains to the period before the said amendment would be notified.

The following Circulars are relevant to note:

Circular No. 46/ 2017-Cus, dated 24.11.2017 regarding in-bond sales makes it explicitly clear that IGST is not applicable until bill of entry for home consumption is filed.

Circular No. 3/ 1/ 2018-IGST, dated 25.05.2018 regarding applicability of Integrated Goods and Services Tax (integrated tax) on goods supplied while being deposited in a customs bonded warehouse – wherein it is clarified that integrated tax shall be levied and collected at the time of final clearance of the warehoused goods for home consumption i.e., at the time of filing the ex-bond bill of entry and the value addition accruing at each stage of supply shall form part of the value on which the integrated tax would be payable at the time of clearance of the warehoused goods for home consumption.

CGST (Amendment) Act, 2018 dated 29.08.2018 (effective from 01.02.2019) Schedule III to CGST Act, 2017 to insert following entries, namely-

- Supply of goods from a place in the non-taxable territory to another place in the non-taxable territory without such goods entering into India;
- Supply of warehoused goods to any person before clearance for home consumption;
- Supply of goods by the consignee to any other person, by endorsement of documents of title to the goods, after the goods have been dispatched from the port of origin located outside India but before clearance for home consumption.

Therefore, these transactions will neither be treated as supply of goods nor supply of services.

Please note that imports will be liable to IGST in addition to Basic Customs Duty and exports will be zero-rated with benefit of refund of attributable input tax credit, or refund of tax paid on such exports. Please refer to the Taxation Amendment Act, 2017 for the necessary amendments made to Customs Tariff Act, 1975 and Central Excise Act, 1944 to enable imposition of BCD+IGST on import of goods liable to GST.

Illustrations: Place of supply of goods imported into, or exported from India**Section 11(a): Import of goods**

Case	Location of supplier	Location of goods before supply	Goods supplied to	Location of recipient	Place of supply
1	Thailand	Thailand	Assam	Assam	Assam
2	China	China	Kashmir	Haryana	Kashmir
3	Sri Lanka	Sri Lanka	Kerala	Kerala	Kerala
4	Karnataka	Iran	Dubai	Karnataka	Not an import since the goods is not brought into India.

Section 11(b): Export of goods

Case	Location of supplier	Location of goods	Goods supplied to	Location of recipient	Place of supply
1	Assam	Assam	Thailand	Assam	Thailand
2	Tamil Nadu	Kashmir	China	Texas	China
3	Sri Lanka	Kerala	Sri Lanka	Sri Lanka	Sri Lanka
4	Maharashtra	Dubai	Iran	Iran	Not an export since the goods is not moving from India.

Another aspect to be carefully considered here is 'bill to-ship to' arrangements involving cross-border trade. It is not important for the supply is 'billed to' a person outside India but the supply is the 'shipped to' a person outside India. In fact, it is not at all relevant where the billing is done 'to' for the transaction to come within the operation of section 11. As mentioned earlier, payment of foreign exchange is not a criterion that determines whether the supply is an export or not. Reference may be had to discussion under section 16 regarding 'supply by way of export' which qualifies for zero-rated benefit. It is sufficient to mention here that in the export – goods shipped to a place outside India – would qualify as an export eligible for zero rated benefit for the second leg of transaction. Exports, therefore, are always determined based on their 'ship to' location being a place outside India whether or not they qualify for the

zero rated benefit under section 16. Similarly, import of goods also are determined based on the 'ship to' location being the place within India with a journey or originating outside India. However, with the *proviso* to section 5(1) imposing GST is not under the IGST Act but under the Customs Tariff Act, as soon as the goods supplied qualify as import of goods under section 11, they attract the incidence of additional customs duty equivalent to IGST. It is important to note that the similarity in the definition of import of goods and export of goods and the dissimilarity in the treatment of GST in these cases.

Statutory provisions

12. Place of supply of services where location of supplier and recipient is in India

- (1) *The provisions of this section shall apply to determine the place of supply of services where the location of supplier of services and the location of the recipient of services is in India.*
- (2) *The place of supply of services, except the services specified in sub-sections (3) to (14)*
- (a) *made to a registered person shall be the location of such person;*
 - (b) *made to any person other than a registered person shall be, —*
 - (i) *the location of the recipient where the address on record exists; and*
 - (ii) *the location of the supplier of services in other cases.*
- (3) *The place of supply of services, —*
- (a) *directly in relation to an immovable property, including services provided by architects, interior decorators, surveyors, engineers and other related experts or estate agents, any service provided by way of grant of rights to use immovable property or for carrying out or co-ordination of construction work; or*
 - (b) *by way of lodging accommodation by a hotel, inn, guest house, home stay, club or campsite, by whatever name called, and including a house boat or any other vessel; or*
 - (c) *by way of accommodation in any immovable property for organizing any marriage or reception or matters related thereto, official, social, cultural, religious or business function including services provided in relation to such function at such property; or*
 - (d) *any services ancillary to the services referred to in clauses (a), (b) and (c), shall be the location at which the immovable property or boat or vessel, as the case may be, is located or intended to be located:*
- Provided that if the location of the immovable property or boat or vessel is located or intended to be located outside India, the place of supply shall be the location of the recipient.*

Explanation. —Where the immovable property or boat or vessel is located in more than one State or Union territory, the supply of services shall be treated as made in each of the respective States or Union territories, in proportion to the value for services separately collected or determined in terms of the contract or agreement entered into in this regard or, in the absence of such contract or agreement, on such other basis as may be prescribed.

- (4) *The place of supply of restaurant and catering services, personal grooming, fitness, beauty treatment, health service including cosmetic and plastic surgery shall be the location where the services are actually performed.*
- (5) *The place of supply of services in relation to training and performance appraisal to, —*
- (a) *a registered person, shall be the location of such person;*
 - (b) *a person other than a registered person, shall be the location where the services are actually performed.*
- (6) *The place of supply of services provided by way of admission to a cultural, artistic, sporting, scientific, educational, entertainment event or amusement park or any other place and services ancillary thereto, shall be the place where the event is actually held or where the park or such other place is located.*
- (7) *The place of supply of services provided by way of, —*
- (a) *organization of a cultural, artistic, sporting, scientific, educational or entertainment event including supply of services in relation to a conference, fair, exhibition, celebration or similar events; or*
 - (b) *services ancillary to organization of any of the events or services referred to in clause (a), or assigning of sponsorship to such events, —*
 - (i) *to a registered person, shall be the location of such person;*
 - (ii) *to a person other than a registered person, shall be the place where the event is actually held and if the event is held outside India, the place of supply shall be the location of the recipient.*
- Explanation.*—Where the event is held in more than one State or Union territory and a consolidated amount is charged for supply of services relating to such event, the place of supply of such services shall be taken as being in each of the respective States or Union territories in proportion to the value for services separately collected or determined in terms of the contract or agreement entered into in this regard or, in the absence of such contract or agreement, on such other basis as may be prescribed.
- (8) *The place of supply of services by way of transportation of goods, including by mail or courier to, —*
- (a) *a registered person, shall be the location of such person;*

(b) a person other than a registered person, shall be the location at which such goods are handed over for their transportation.

Provided that where the transportation of goods is to a place outside India, the place of supply shall be the place of destination of such goods⁴

(9) The place of supply of passenger transportation service to, —

(a) a registered person, shall be the location of such person;

(b) a person other than a registered person, shall be the place where the passenger embarks on the conveyance for a continuous journey:

Provided that where the right to passage is given for future use and the point of embarkation is not known at the time of issue of right to passage, the place of supply of such service shall be determined in accordance with the provisions of sub-section (2).

Explanation. —For the purposes of this sub-section, the return journey shall be treated as a separate journey, even if the right to passage for onward and return journey is issued at the same time.

(10) The place of supply of services on board a conveyance, including a vessel, an aircraft, a train or a motor vehicle, shall be the location of the first scheduled point of departure of that conveyance for the journey.

(11) The place of supply of telecommunication services including data transfer, broadcasting, cable and direct to home television services to any person shall, —

(a) in case of services by way of fixed telecommunication line, leased circuits, internet leased circuit, cable or dish antenna, be the location where the telecommunication line, leased circuit or cable connection or dish antenna is installed for receipt of services;

(b) in case of mobile connection for telecommunication and internet services provided on post-paid basis, be the location of billing address of the recipient of services on the record of the supplier of services;

(c) in cases where mobile connection for telecommunication, internet service and direct to home television services are provided on pre-payment basis through a voucher or any other means, —

(i) through a selling agent or a re-seller or a distributor of subscriber identity module card or re-charge voucher, be the address of the selling agent or re-seller or distributor as per the record of the supplier at the time of supply; or

(ii) by any person to the final subscriber, be the location where such pre-payment is received or such vouchers are sold;

⁴ Inserted vide The Integrated Goods and Services Tax Amendment Act, 2018 w.e.f. 01.02.2019

(d) *in other cases, be the address of the recipient as per the records of the supplier of services and where such address is not available, the place of supply shall be location of the supplier of services:*

Provided that where the address of the recipient as per the records of the supplier of services is not available, the place of supply shall be location of the supplier of services:

Provided further that if such pre-paid service is availed or the recharge is made through internet banking or other electronic mode of payment, the location of the recipient of services on the record of the supplier of services shall be the place of supply of such services.

Explanation.—Where the leased circuit is installed in more than one State or Union territory and a consolidated amount is charged for supply of services relating to such circuit, the place of supply of such services shall be taken as being in each of the respective States or Union territories in proportion to the value for services separately collected or determined in terms of the contract or agreement entered into in this regard or, in the absence of such contract or agreement, on such other basis as may be prescribed.

(12) *The place of supply of banking and other financial services, including stock broking services to any person shall be the location of the recipient of services on the records of the supplier of services:*

Provided that if the location of recipient of services is not on the records of the supplier, the place of supply shall be the location of the supplier of services.

(13) *The place of supply of insurance services shall, —*

(a) *to a registered person, be the location of such person;*

(b) *to a person other than a registered person, be the location of the recipient of services on the records of the supplier of services.*

(14) *The place of supply of advertisement services to the Central Government, a State Government, a statutory body or a local authority meant for the States or Union territories identified in the contract or agreement shall be taken as being in each of such States or Union territories and the value of such supplies specific to each State or Union territory shall be in proportion to the amount attributable to services provided by way of dissemination in the respective States or Union territories as may be determined in terms of the contract or agreement entered into in this regard or, in the absence of such contract or agreement, on such other basis as may be prescribed.*

Extract of the IGST Rules

Rule 3. *The proportion of value attributable to different States or Union territories, in the*

case of supply of advertisement services to the Central Government, a State Government, a statutory body or a local authority, under sub section (14) of section 12 of the Integrated Goods and Services Tax Act, 2017, in the absence of any contract between the supplier of service and recipient of services, shall be determined in the following manner namely:—

- (a) In the case of newspapers and publications, the amount payable for publishing an advertisement in all the editions of a newspaper or publication, which are published in a State or Union territory, as the case may be, is the value of advertisement service attributable to the dissemination in such State or Union territory.

Illustration: ABC is a government agency which deals with the all the advertisement and publicity of the Government. It has various wings dealing with various types of publicity. In furtherance thereof, it issues release orders to various agencies and entities. These agencies and entities thereafter provide the service and then issue invoices to ABC indicating the amount to be paid by them. ABC issues a release order to a newspaper for an advertisement on 'Beti bachao beti padhao', to be published in the newspaper DEF (whose head office is in Delhi) for the editions of Delhi, Pune, Mumbai, Lucknow and Jaipur. The release order will have details of the newspaper like the periodicity, language, size of the advertisement and the amount to be paid to such a newspaper. The place of supply of this service shall be in the Union territory of Delhi, and the States of Maharashtra, Uttar Pradesh and Rajasthan. The amounts payable to the Pune and Mumbai editions would constitute the proportion of value for the State of Maharashtra which is attributable to the dissemination in Maharashtra. Likewise the amount payable to the Delhi, Lucknow and Jaipur editions would constitute the proportion of value attributable to the dissemination in the Union territory of Delhi and States of Uttar Pradesh and Rajasthan respectively. DEF should issue separate State wise and Union territory wise invoices based on the editions.

- (b) in the case of printed material like pamphlets, leaflets, diaries, calendars, T shirts etc, the amount payable for the distribution of a specific number of such material in a particular State or Union territory is the value of advertisement service attributable to the dissemination in such State or Union territory, as the case may be.

Illustration: As a part of the campaign 'Swachh Bharat', ABC has engaged a company GH for printing of one lakh pamphlets (at a total cost of one lakh rupees) to be distributed in the States of Haryana, Uttar Pradesh and Rajasthan. In such a case, ABC should ascertain the breakup of the pamphlets to be distributed in each of the three States i.e. Haryana, Uttar Pradesh and Rajasthan, from the Ministry or department concerned at the time of giving the print order. Let us assume that this breakup is twenty thousand, fifty thousand and thirty thousand respectively. This breakup should be indicated in the print order. The place of supply of this service is in Haryana, Uttar Pradesh and Rajasthan. The ratio of this breakup i.e. 2:5:3 will form the basis of value attributable to the dissemination in each of the three States. Separate invoices will have to be issued State wise by GH to ABC indicating the value

pertaining to that State i.e. twenty thousand rupees-Haryana, fifty thousand rupees-Uttar Pradesh and thirty thousand rupees-Rajasthan.

- (c) (i) *in the case of hoardings other than those on trains, the amount payable for the hoardings located in each State or Union territory, as the case may be, is the value of advertisement service attributable to the dissemination in each such State or Union territory, as the case may be.*

Illustration: ABC as part of the campaign 'Saakshar Bharat' has engaged a firm IJ for putting up hoardings near the Airports in the four metros i.e. Delhi, Mumbai, Chennai and Kolkata. The release order issued by ABC to IJ will have the city wise, location wise breakup of the amount payable for such hoardings. The place of supply of this service is in the Union territory of Delhi and the States of Maharashtra, Tamil Nadu and West Bengal. In such a case, the amount actually paid to IJ for the hoardings in each of the four metros will constitute the value attributable to the dissemination in the Union territory of Delhi and the States of Maharashtra, Tamil Nadu and West Bengal respectively. Separate invoices will have to be issued State wise and Union territory wise by IJ to ABC indicating the value pertaining to that State or Union territory.

(ii) *in the case of advertisements placed on trains, the breakup, calculated on the basis of the ratio of the length of the railway track in each State for that train, of the amount payable for such advertisements is the value of advertisement service attributable to the dissemination in such State or Union territory, as the case may be.*

Illustration: ABC places an order on KL for advertisements to be placed on a train with regard to the "Janani Suraksha Yojana". The length of a track in a State will vary from train to train. Thus for advertisements to be placed on the Hazrat Nizamuddin Vasco Da Gama Goa Express which runs through Delhi, Haryana, Uttar Pradesh, Madhya Pradesh, Maharashtra, Karnataka and Goa, KL may ascertain the total length of the track from Hazrat Nizamuddin to Vasco Da Gama as well as the length of the track in each of these States and Union territory from the website www.indianrail.gov.in. The place of supply of this service is in the Union territory of Delhi and States of Haryana, Uttar Pradesh, Madhya Pradesh, Maharashtra, Karnataka and Goa. The value of the supply in each of these States and Union territory attributable to the dissemination in these States will be in the ratio of the length of the track in each of these States and Union territory. If this ratio works out to say 0.5:0.5: 2:2 :3:3:1 , and the amount to be paid to KL is one lakh twenty thousand rupees, then KL will have to calculate the State wise and Union territory wise breakup of the value of the service, which will be in the ratio of the length of the track in each State and Union territory. In the given example the State wise and Union territory wise breakup works out to Delhi (five thousand rupees), Haryana (five thousand rupees), Uttar Pradesh (twenty thousand rupees), Madhya Pradesh (twenty thousand rupees), Maharashtra (thirty thousand rupees), Karnataka (thirty thousand rupees) and Goa (ten thousand rupees). Separate

invoices will have to be issued State wise and Union territory wise by KL to ABC indicating the value pertaining to that State or Union territory.

- (d) (i) *in the case of advertisements on the back of utility bills of oil and gas companies etc, the amount payable for the advertisements on bills pertaining to consumers having billing addresses in such States or Union territory as the case may be, is the value of advertisement service attributable to dissemination in such State or Union territory.*

(ii) *in the case of advertisements on railway tickets, the breakup, calculated on the basis of the ratio of the number of Railway Stations in each State or Union territory, when applied to the amount payable for such advertisements, shall constitute the value of advertisement service attributable to the dissemination in such State or Union territory, as the case may be.*

Illustration: ABC has issued a release order to MN for display of advertisements relating to the "Ujjwala" scheme on the railway tickets that are sold from all the Stations in the States of Madhya Pradesh and Chattisgarh. The place of supply of this service is in Madhya Pradesh and Chattisgarh. The value of advertisement service attributable to these two States will be in the ratio of the number of railway stations in each State as ascertained from the Railways or from the website www.indianrail.gov.in. Let us assume that this ratio is 713:251 and the total bill is rupees nine thousand six hundred and forty. The breakup of the amount between Madhya Pradesh and Chattisgarh in this ratio of 713:251 works out to seven thousand one hundred and thirty rupees and two thousand five hundred and ten rupees respectively. Separate invoices will have to be issued State wise by MN to ABC indicating the value pertaining to that State.

- (e) *in the case of advertisements over radio stations the amount payable to such radio station, which by virtue of its name is part of a State or Union territory, as the case may be, is the value of advertisement service attributable to dissemination in such State or Union territory, as the case may be.*

Illustration: For an advertisement on 'Pradhan Mantri Ujjwala Yojana', to be broadcast on a FM radio station OP, for the radio stations of OP Kolkata, OP Bhubaneswar, OP Patna, OP Ranchi and OP Delhi, the release order issued by ABC will show the breakup of the amount which is to be paid to each of these radio stations. The place of supply of this service is in West Bengal, Odisha, Bihar, Jharkhand and Delhi. The place of supply of OP Delhi is in Delhi even though the studio may be physically located in another State. Separate invoices will have to be issued State wise and Union territory wise by MN to ABC based on the value pertaining to each State or Union territory.

- (f) *in the case of advertisement on television channels, the amount attributable to the value of advertisement service disseminated in a State shall be calculated on the*

basis of the viewership of such channel in such State, which in turn, shall be calculated in the following manner, namely:—

- (i) the channel viewership figures for that channel for a State or Union territory shall be taken from the figures published in this regard by the Broadcast Audience Research Council;
- (ii) the figures published for the last week of a given quarter shall be used for calculating viewership for the succeeding quarter and at the beginning, the figures for the quarter 1st July, 2017 to 30th September, 2017 shall be used for the succeeding quarter 1st October, 2017 to 31st December, 2017;
- (iii) where such channel viewership figures relate to a region comprising of more than one State or Union territory, the viewership figures for a State or Union territory of that region, shall be calculated by applying the ratio of the populations of that State or Union territory, as determined in the latest Census, to such viewership figures;
- (iv) the ratio of the viewership figures for each State or Union territory as so calculated, when applied to the amount payable for that service, shall represent the portion of the value attributable to the dissemination in that State or Union territory.

Illustration: ABC issues a release order with QR channel for telecasting an advertisement relating to the “Pradhan Mantri Kaushal Vikas Yojana” in the month of November, 2017. In the first phase, this will be telecast in the Union territory of Delhi, States of Uttar Pradesh, Uttarakhand, Bihar and Jharkhand. The place of supply of this service is in Delhi, Uttar Pradesh, Uttarakhand, Bihar and Jharkhand. In order to calculate the value of supply attributable to Delhi, Uttar Pradesh, Uttarakhand, Bihar and Jharkhand, QR has to proceed as under—

- I. QR will ascertain the viewership figures for their channel in the last week of September 2017 from the Broadcast Audience Research Council. Let us assume it is one lakh for Delhi and two lakhs for the region comprising of Uttar Pradesh and Uttarakhand and one lakh for the region comprising of Bihar and Jharkhand;
- II. since the Broadcast Audience Research Council clubs Uttar Pradesh and Uttarakhand into one region and Bihar and Jharkhand into another region, QR will ascertain the population figures for Uttar Pradesh, Uttarakhand, Bihar and Jharkhand from the latest census;
- III. by applying the ratio of the populations of Uttar Pradesh and Uttarakhand, as so ascertained, to the Broadcast Audience Research Council viewership figures for their channel for this region, the viewership figures for Uttar Pradesh and Uttarakhand and consequently the ratio of these viewership figures can be

calculated. Let us assume that the ratio of the populations of Uttar Pradesh and Uttarakhand works out to 9: 1. When this ratio is applied to the viewership figures of two lakhs for this region, the viewership figures for Uttar Pradesh and Uttarakhand work out to one lakh eighty thousand and twenty thousand respectively;

IV. in a similar manner the breakup of the viewership figures for Bihar and Jharkhand can be calculated. Let us assume that the ratio of populations is 4:1 and when this is applied to the viewership figure of one lakh for this region, the viewership figure for Bihar and Jharkhand works out to eighty thousand and twenty thousand respectively;

V. the viewership figure for each State works out to Delhi (one lakh), Uttar Pradesh (one lakh eighty thousand), Uttarakhand (twenty thousand), Bihar (eighty thousand) and Jharkhand (twenty thousand). The ratio is thus 10:18:2:8:2 or 5:9:1:4:1 (simplification).

VI. this ratio has to be applied when indicating the breakup of the amount pertaining to each State. Thus if the total amount payable to QR by ABC is twenty lakh rupees, the State wise breakup is five lakh rupees (Delhi), nine lakh rupees (Uttar Pradesh) one lakh rupees (Uttarakhand), four lakh rupees (Bihar) and one lakh rupees (Jharkhand). Separate invoices will have to be issued State wise and Union territory wise by QR to ABC indicating the value pertaining to that State or Union territory.

- (g) in the case of advertisements at cinema halls the amount payable to a cinema hall or screens in a multiplex, in a State or Union territory, as the case may be, is the value of advertisement service attributable to dissemination in such State or Union territory, as the case may be.

Illustration: ABC commissions ST for an advertisement on 'Pradhan Mantri Awas Yojana' to be displayed in the cinema halls in Chennai and Hyderabad. The place of supply of this service is in the States of Tamil Nadu and Telangana. The amount actually paid to the cinema hall or screens in a multiplex, in Tamil Nadu and Telangana as the case may be, is the value of advertisement service in Tamil Nadu and Telangana respectively. Separate invoices will have to be issued State wise and Union territory wise by ST to ABC indicating the value pertaining to that State.

- (h) in the case of advertisements over internet, the service shall be deemed to have been provided all over India and the amount attributable to the value of advertisement service disseminated in a State or Union territory shall be calculated on the basis of the internet subscribers in such State or Union territory, which in turn, shall be calculated in the following manner, namely: —

(i) the internet subscriber figures for a State shall be taken from the figures

published in this regard by the Telecom Regulatory Authority of India;

- (ii) the figures published for the last quarter of a given financial year shall be used for calculating the number of internet subscribers for the succeeding financial year and at the beginning, the figures for the last quarter of financial year 2016-2017 shall be used for the succeeding financial year 2017-2018;*
- (iii) where such internet subscriber figures relate to a region comprising of more than one State or Union territory, the subscriber figures for a State or Union territory of that region, shall be calculated by applying the ratio of the populations of that State or Union territory, as determined in the latest census, to such subscriber figures;*
- (iv) the ratio of the subscriber figures for each State or Union territory as so calculated, when applied to the amount payable for this service, shall represent the portion of the value attributable to the dissemination in that State or Union territory.*

Illustration: ABC issues a release order to WX for a campaign over internet regarding linking Aadhaar with one's bank account and mobile number. WX runs this campaign over certain websites. In order to ascertain the State wise breakup of the value of this service which is to be reflected in the invoice issued by WX to ABC, WX has to first refer to the Telecom Regulatory Authority of India figures for quarter ending March, 2017, as indicated on their website www.trai.gov.in. These figures show the service area wise internet subscribers. There are twenty two service areas. Some relate to individual States some to two or more States and some to part of one State and another complete State. Some of these areas are metropolitan areas. In order to calculate the State wise breakup, first the State wise breakup of the number of internet subscribers is arrived at. (In case figures of internet subscribers of one or more States are clubbed, the subscribers in each State is to be arrived at by applying the ratio of the respective populations of these States as per the latest census.). Once the actual number of subscribers for each State has been determined, the second step for WX involves calculating the State wise ratio of internet subscribers. Let us assume that this works out to 8: 1 : 2... and so on for Andhra Pradesh, Arunachal Pradesh, Assam..... and so on. The third step for WX will be to apply these ratios to the total amount payable to WX so as to arrive at the value attributable to each State. Separate invoices will have to be issued State wise and Union territory wise by WX to ABC indicating the value pertaining to that State or Union territory.

- (i) in the case of advertisements through short messaging service the amount attributable to the value of advertisement service disseminated in a State or Union territory shall be calculated on the basis of the telecommunication (herein after referred to as telecom) subscribers in such State or Union territory, which in turn, shall*

be calculated in the following manner, namely:-

- (a) the number of telecom subscribers in a telecom circle shall be ascertained from the figures published by the Telecom Regulatory Authority of India on its website www.trai.gov.in;
- (b) the figures published for a given quarter, shall be used for calculating subscribers for the succeeding quarter and at the beginning, the figures for the quarter 1st July, 2017 to 30th September, 2017 shall be used for the succeeding quarter 1st October, 2017 to 31st December, 2017;
- (c) where such figures relate to a telecom circle comprising of more than one State, or Union territory, the subscriber figures for that State or Union territory shall be calculated by applying the ratio of the populations of that State or Union territory, as determined in the latest census, to such subscriber figures.

Illustration-1: In the case of the telecom circle of Assam, the amount attributed to the telecom circle of Assam is the value of advertisement service in Assam.

Illustration-2: The telecom circle of North East covers the States of Arunachal Pradesh, Meghalaya, Mizoram, Nagaland, Manipur and Tripura. The ratio of populations of each of these States in the latest census will have to be determined and this ratio applied to the total number of subscribers for this telecom circle so as to arrive at the State wise figures of telecom subscribers. Separate invoices will have to be issued State wise by the service provider to ABC indicating the value pertaining to that State.

Illustration-3: ABC commissions UV to send short messaging service to voters asking them to exercise their franchise in elections to be held in Maharashtra and Goa. The place of supply of this service is in Maharashtra and Goa. The telecom circle of Maharashtra consists of the area of the State of Maharashtra (excluding the areas covered by Mumbai which forms another circle) and the State of Goa. When calculating the number of subscribers pertaining to Maharashtra and Goa, UV has to—

- I. obtain the subscriber figures for Maharashtra circle and Mumbai circle and add them to obtain a combined figure of subscribers;
- II. obtain the figures of the population of Maharashtra and Goa from the latest census and derive the ratio of these two populations;
- III. this ratio will then have to be applied to the combined figure of subscribers so as to arrive at the separate figures of subscribers pertaining to Maharashtra and Goa;
- IV. the ratio of these subscribers when applied to the amount payable for the short messaging service in Maharashtra circle and Mumbai circle, will give breakup of the amount pertaining to Maharashtra and Goa. Separate

invoices will have to be issued State wise by UV to ABC indicating the value pertaining to that State.

Illustration-4: *The telecom circle of Andhra Pradesh consists of the areas of the States of Andhra Pradesh, Telangana and Yanam, an area of the Union territory of Puducherry. The subscribers attributable to Telangana and Yanam will have to be excluded when calculating the subscribers pertaining to Andhra Pradesh.*

- (d) *the ratio of the subscriber figures for each State or Union territory as so calculated, when applied to the amount payable for that service, shall represent the portion of the value attributable to the dissemination in that State or Union territory.*

Rule 4 *The supply of services attributable to different States or Union territories, under sub section (3) of section 12 of the Integrated Goods and Services Tax Act, 2017 (hereinafter in these rules referred to as the said Act), in the case of-*

- (a) *services directly in relation to immovable property, including services provided by architects, interior decorators, surveyors, engineers and other related experts or estate agents, any service provided by way of grant of rights to use immovable property or for carrying out or co-ordination of construction work; or*
- (b) *lodging accommodation by a hotel, inn, guest house, homestay, club or campsite, by whatever name called, and including a houseboat or any other vessel; or*
- (c) *accommodation in any immovable property for organising any marriage or reception or matters related thereto, official, social, cultural, religious or business function including services provided in relation to such function at such property; or*
- (d) *any services ancillary to the services referred to in clauses (a), (b) and (c),*

where such immovable property or boat or vessel is located in more than one State or Union territory, shall be taken as being in each of the respective States or Union territories, and in the absence of any contract or agreement between the supplier of service and recipient of services for separately collecting or determining the value of the services in each such State or Union territory, as the case maybe, shall be determined in the following manner namely:-

- (i) *in case of services provided by way of lodging accommodation by a hotel, inn, guest house, club or campsite, by whatever name called (except cases where such property is a single property located in two or more contiguous States or Union territories or both) and services ancillary to such services, the supply of services shall be treated as made in each of the respective States or Union territories, in proportion to the number of nights stayed in such property;*
- (ii) *in case of all other services in relation to immovable property including services by way of accommodation in any immovable property for organising any marriage or*

reception etc., and in cases of supply of accommodation by a hotel, inn, guest house, club or campsite, by whatever name called where such property is a single property located in two or more contiguous States or Union territories or both, and services ancillary to such services, the supply of services shall be treated as made in each of the respective States or Union territories, in proportion to the area of the immovable property lying in each State or Union territory;

- (iii) in case of services provided by way of lodging accommodation by a house boat or any other vessel and services ancillary to such services, the supply of services shall be treated as made in each of the respective States or Union territories, in proportion to the time spent by the boat or vessel in each such State or Union territory, which shall be determined on the basis of a declaration made to the effect by the service provider.

Illustration 1: A hotel chain X charges a consolidated sum of Rs.30,000/- for stay in its two establishments in Delhi and Agra, where the stay in Delhi is for 2 nights and the stay in Agra is for 1 night. The place of supply in this case is both in the Union territory of Delhi and in the State of Uttar Pradesh and the service shall be deemed to have been provided in the Union territory of Delhi and in the State of Uttar Pradesh in the ratio 2:1 respectively. The value of services provided will thus be apportioned as Rs.20,000/- in the Union territory of Delhi and Rs.10,000/- in the State of Uttar Pradesh .

Illustration 2: There is a piece of land of area 20,000 square feet which is partly in State S1 say 12,000 square feet and partly in State S2, say 8000 square feet. Site preparation work has been entrusted to T. The ratio of land in the two states works out to 12:8 or 3:2 (simplified). The place of supply is in both S1 and S2. The service shall be deemed to have been provided in the ratio of 12:8 or 3:2 (simplified) in the States S1 and S2 respectively. The value of the service shall be accordingly apportioned between the States.

Illustration 3: A company C provides the service of 24 hours accommodation in a houseboat, which is situated both in Kerala and Karnataka inasmuch as the guests board the house boat in Kerala and stay there for 22 hours but it also moves into Karnataka for 2 hours (as declared by the service provider). The place of supply of this service is in the States of Kerala and Karnataka. The service shall be deemed to have been provided in the ratio of 22:2 or 11:1 (simplified) in the states of Kerala and Karnataka, respectively. The value of the service shall be accordingly apportioned between the States.

Rule 5. The supply of services attributable to different States or Union territories, under sub-section (7) of section 12 of the said Act, in the case of-

- (a) services provided by way of organisation of a cultural, artistic, sporting, scientific, educational or entertainment event , including supply of services in relation to a conference, fair exhibition, celebration or similar events; or
- (b) services ancillary to the organisation of any such events or assigning of sponsorship

to such events ,

where the services are supplied to a person other than a registered person, the event is held in India in more than one State or Union territory and a consolidated amount is charged for supply of such services, shall be taken as being in each of the respective States or Union territories, and in the absence of any contract or agreement between the supplier of service and recipient of services for separately collecting or determining the value of the services in each such State or Union territory, as the case maybe, shall be determined by application of the generally accepted accounting principles.

Illustration: An event management company E has to organise some promotional events in States S1 and S2 for a recipient R. 3 events are to be organised in S1 and 2 in S2. They charge a consolidated amount of Rs.10,00,000 from R. The place of supply of this service is in both the States S1 and S2. Say the proportion arrived at by the application of generally accepted accounting principles is 3:2. The service shall be deemed to have been provided in the ratio 3:2 in S1 and S2 respectively. The value of services provided will thus be apportioned as Rs. 6,00,000/- in S1 and Rs. 4,00,000/- in S2 .

Rule 6. The supply of services attributable to different States or Union territories, under sub section (11) of section 12 of the said Act, in the case of supply of services relating to a leased circuit where the leased circuit is installed in more than one State or Union territory and a consolidated amount is charged for supply of such services, shall be taken as being in each of the respective States or Union territories, and in the absence of any contract or agreement between the supplier of service and recipient of services for separately collecting or determining the value of the services in each such State or Union territory, as the case maybe, shall be determined in the following manner, namely:-

- (a) The number of points in a circuit shall be determined in the following manner:
 - (i) in the case of a circuit between two points or places, the starting point or place of the circuit and the end point or place of the circuit will invariably constitute two points;
 - (ii) any intermediate point or place in the circuit will also constitute a point provided that the benefit of the leased circuit is also available at that intermediate point;
- (b) the supply of services shall be treated as made in each of the respective States or Union territories, in proportion to the number of points lying in the State or Union territory.

Illustration 1: A company T installs a leased circuit between the Delhi and Mumbai offices of a company C. The starting point of this circuit is in Delhi and the end point of the circuit is in Mumbai. Hence one point of this circuit is in Delhi and another in Maharashtra. The place of supply of this service is in the Union territory of Delhi and the State of Maharashtra. The

service shall be deemed to have been provided in the ratio of 1:1 in the Union territory of Delhi and the State of Maharashtra, respectively.

Illustration 2: A company T installs a leased circuit between the Chennai, Bengaluru and Mysuru offices of a company C. The starting point of this circuit is in Chennai and the end point of the circuit is in Mysuru. The circuit also connects Bengaluru. Hence one point of this circuit is in Tamil Nadu and two points in Karnataka. The place of supply of this service is in the States of Tamil Nadu and Karnataka. The service shall be deemed to have been provided in the ratio of 1:2 in the States of Tamil Nadu and Karnataka, respectively.

Illustration 3: A company T installs a leased circuit between the Kolkata, Patna and Guwahati offices of a company C. There are 3 points in this circuit in Kolkata, Patna and Guwahati. One point each of this circuit is, therefore, in West Bengal, Bihar and Assam. The place of supply of this service is in the States of West Bengal, Bihar and Assam. The service shall be deemed to have been provided in the ratio of 1:1:1 in the States of West Bengal, Bihar and Assam, respectively.

Relevant circulars, notifications, clarifications issued by Government:

1. Notification No. 12/ 2017-Integrated Tax, dated 15.11.2017 notified IGST (Amendment) Rules, 2017, inserting rule 3 for apportionment of IGST with respect to advertisement services under section 12(14) of the IGST Act, 2017;
2. Notification No. 4/ 2018-Integrated Tax, dated 31.12.2018 notified IGST (Amendment) Rules, 2018, to insert rules 4, 5, 6, 7, 8 and 9.
3. Circular No. 2/ 1/ 2017-IGST, dated 27.09.2017 for clarification on the place of supply of satellite launch services by ANTRIX Corporation Ltd.;
4. Circular No. 48/ 22/ 2018-GST, dated 14.06.2018 clarifying that services of short-term accommodation etc. provided to a SEZ shall be treated as inter-State supply.

Related Provisions of the Statute

Statute	Section / Rule	Description
CGST	Section 2(2)	Definition of address on record
CGST	Section 2(34)	Definition of conveyance
CGST	Section 2(56)	Definition of India
CGST	Section 2(93)	Definition of recipient
CGST	Section 9	Levy and collection of tax
IGST	Section 2(3)	Definition of continuous journey

IGST	Section 2(6)	Definition of export of services
IGST	Section 2(11)	Definition of import of services
IGST	Section 2(13)	Definition of intermediary
IGST	Section 2(14)	Definition of location of the recipient of services
IGST	Section 2(15)	Definition of location of the supplier of services
IGST	Section 5	Levy and collection of tax
IGST	Section 7	Meaning of inter-State supplies
IGST	Section 8	Meaning of intra-State supplies
IGST	Section 10	Place of supply of goods other than goods imported into, or exported from India
IGST	Section 11	Place of supply of goods imported into, or exported from India
IGST	Section 13	Place of supply of services where location of supplier or location of recipient is outside India
IGST	Section 14	Special provision for payment of tax by a supplier of OIDAR services

12.1 Important Definitions

(a) Location of recipient of services:

Section 2(14) of the IGST Act, 2017 defines "location of the recipient of services" as:

- (a) where a supply is received at a place of business for which the registration has been obtained, the location of such place of business;
- (b) where a supply is received at a place other than the place of business for which registration has been obtained (a fixed establishment elsewhere), the location of such fixed establishment;
- (c) where a supply is received at more than one establishment, whether the place of business or fixed establishment, the location of the establishment most directly concerned with the receipt of the supply; and
- (d) in absence of such places, the location of the usual place of residence of the recipient.

(b) Location of the supplier of services:

Section 2(15) of the IGST Act, 2017 defines "location of the supplier of services" as:

- (a) where a supply is made from a place of business for which the registration has been obtained, the location of such place of business;

- (b) where a supply is made from a place other than the place of business for which registration has been obtained (a fixed establishment elsewhere), the location of such fixed establishment;
- (c) where a supply is made from more than one establishment, whether the place of business or fixed establishment, the location of the establishment most directly concerned with the provision of the supply; and
- (d) in absence of such places, the location of the usual place of residence of the supplier;

12.2 Analysis

Place of Supply – Supplies within India

Place of supply (known as POS) of services where both the supplier and recipient are located within India will be determined in accordance with section 12 of the IGST Act.

- (i) The general provision to determine the place of supply in respect of supply of services will be as follows:
 - Services supplied to a recipient who is registered, POS will be the location of such person;
 - Services supplied to a recipient who is not registered, POS will be the address on record of such person and where such address is not available, it will be the location of supplier.

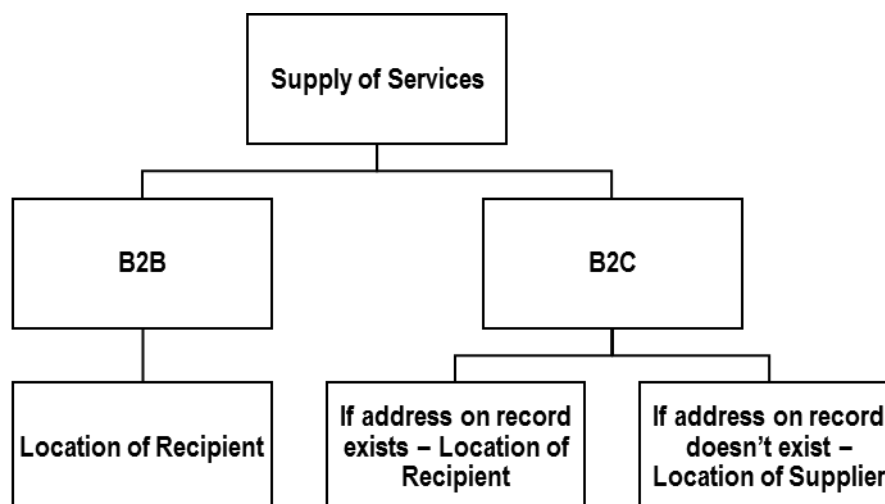

There could be a scenario where multiple POS in the same invoice to a particular customer because of supply of distinct goods and goods, or services and services, or goods and services may get covered. In such a case, the supplier has to issue separate invoices where each invoice will have only one POS. This method is also supported by

the fact that FORM GSTR-1 (Details of Outward supply) does not allow one to key in two different POS for the same invoice.

It is crucial to note that under the erstwhile Service tax regime, the scheme of centralised registration was available, by virtue of which, the location of the recipient was always construed to be the registered address in the statutory records. However, under the GST law, a separate registration is required to be obtained in every State/ UT from where a person effects taxable supplies. Accordingly, due caution must be exercised to provide for what is to be the location of the recipient, where the place of supply is determined to be the location of the registered person, under this clause, or any other clauses of section 12/ 13 of the IGST Act.

(ii) Specific provisions regarding place of supply that will apply in priority over the aforesaid general provision are as follows:

- (a) Services directly in relation to immovable property will be the location of such property. The expression 'in relation to' encompasses a wide range of services that have a proximate nexus with the immovable property. The provision lists these services – architects, interior decorators, surveyors, engineers and other related experts or estate agents, grant of rights to use immovable property or carrying out/ coordination of construction work. As can be seen, this list is not exhaustive and therefore – 'in relation to' – test will continue to be applicable to identify the services that will have the location of the property as its place of supply.

Also, the location of the supplier or recipient is irrelevant in such cases. Further, there are other services that have proximity to immovable property that are 'by way of' accommodation. Such services too have, as their place of supply, the location of such property. Such property may be a hotel, inn, guest house, homestay, club or campsite including houseboat. The use of such property may be accommodation or for organizing a function such as marriage. The end-use will not alter the applicability of this provision but the proximity of the property vis-à-vis the services. Services that are ancillary to such services would also be covered by this provision.

Circular No. 48/ 22/ 2018-GST, dated 14.06.2018 in the context of services of short-term accommodation, conferencing, banqueting etc. provided to a Special Economic Zone (SEZ) developer or a SEZ unit has clarified that such service shall be treated as inter-State supply.

Further, goods required in construction activity received as stock before being assigned to any particular site will not be determined by this provision but the general provision. For example, steel purchased in bulk and sent to a central

warehouse being deployed to any specific site.

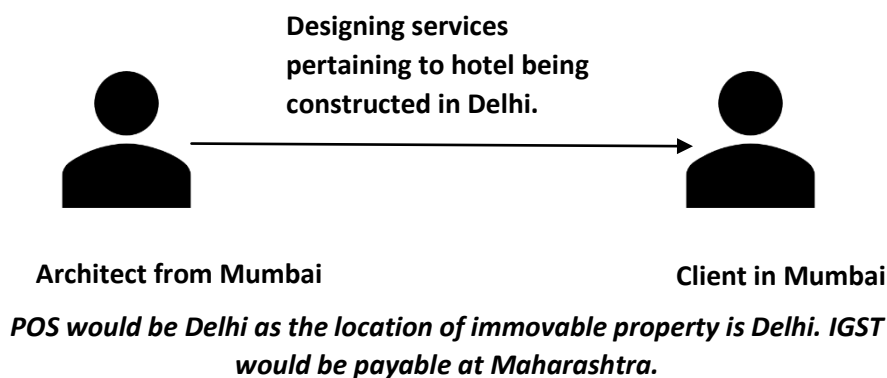

Also, Referral fees paid, events organised amongst group companies, food testing charges in a hospitality industry will not fall under the said provision as the same is not directly in relation to immovable property and hence the same will be classified under general provision 12(1) and if the recipient is situated outside the state, the same will be an inter state supply.

Rule 4 of IGST Rules provides that where immovable property or boat or vessel is located in more than one State or and in the absence of any contract or agreement, the value shall be determined in the following manner-

- a) in case of services provided by way of lodging accommodation by a hotel, inn, guest house, club or campsite, by whatever name called (except cases where such property is a single property located in two or more contiguous States/ UT) and services ancillary to such services, the supply of services shall be treated as made in each of the respective States/ UT, in proportion to the number of nights stayed in such property;
- b) in case of all other services in relation to immovable property including services by way of accommodation in any immovable property for organising any marriage or reception etc., and in cases of supply of accommodation by a hotel, inn, guest house, club or campsite, by whatever name called where such property is a single property located in two or more contiguous States/ UT, and services ancillary to such services, the supply of services shall be treated as made in each of the respective States/ UT, in proportion to the area of the immovable property lying in each State/ UT;
- c) in case of services provided by way of lodging accommodation by a house boat or any other vessel and services ancillary to such services, the supply of services shall be treated as made in each of the respective States/ UT, in proportion to the time spent by the boat or vessel in each such State/ UT, which shall be determined on the basis of a declaration made to the effect by the service provider.

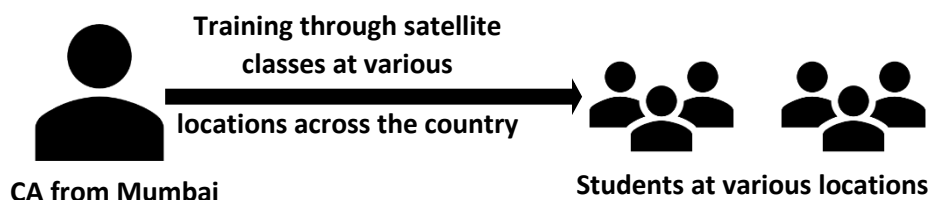

POS would be Mumbai as that is the place where service is performed. CGST + Maharashtra GST would be payable at Maharashtra.

- (d) Services of **admission** to a venue will be the location of the venue. The event that is organized may be cultural, artistic, sporting, scientific, education or entertainment or an amusement park including ancillary services. Services referred to here are only 'admission' and not for organizing the event at the venue.

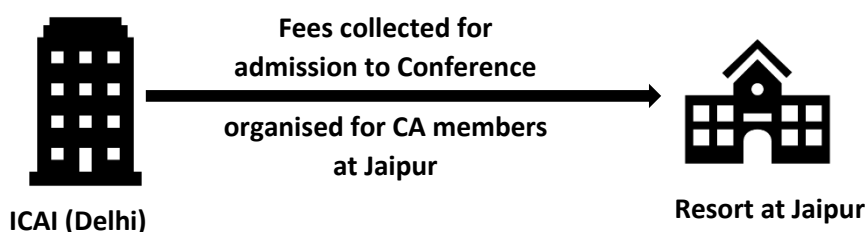

POS would be Jaipur as that is the place where event is actually held. IGST would be payable at Delhi.

- (e) Services of **organizing** an event including ancillary services supplied to a registered person will be the location of the recipient. When the recipient is not registered, the place of supply will be the location of the venue itself.

The event that is organized may be cultural, artistic, sporting, scientific, education or entertainment. Services referred to here are 'by way of' organizing the event at the venue. Where the event is organized in a ground or field being an immovable property, the service of securing the location has, as its place of supply, determined by a foregoing provision but the rest of the services of organizing the event alone will fall in this provision.

Rule 5 of IGST Rules provides that where services of organizing the event are supplied to unregistered person and the event is held in India in more than one State/ UT, the value of service in such State/ UT shall be determined by application of generally accepted accounting principles.

On a comparison of this provision with the previous provision, the striking difference is that in case of B2B transaction for admission to an event, the POS would be the location of the event whereas services of organizing the event is based on the location of the recipient in case of B2B supplies (i.e., where the recipient is a registered person).

- (f) Services of transportation of goods supplied to a registered person will be the location of the recipient being a registered person. When the recipient is not registered, the place of supply will be the location where goods are handed over for such transportation. Transportation of goods may be by any mode including mail or courier.

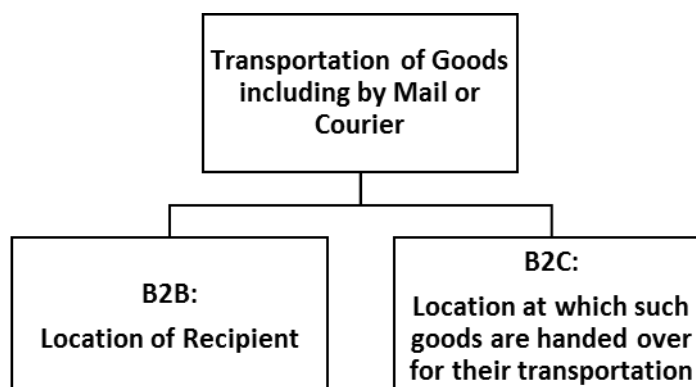

However, vide IGST (Amendment) Act, 2018, dated 29-Aug-2018 (effectiveness is yet to be notified), a proviso is inserted to provide that where the transportation of goods is to a place outside India, the place of supply will be the place of destination of goods.

- (g) Services of transportation of passenger will be the location of the registered recipient (including where an employee of a registered person travels on business). When the recipient is not a registered person, the place of supply will be the location of embarkation. Please note that a return journey is regarded as a separate journey (even in case of bookings of round-trips). Where the point of embarkation is unknown (in cases where the right to passage is given for future use) then the place of supply will be determined under the general clause (i.e., Section 12(2) of the IGST Act).

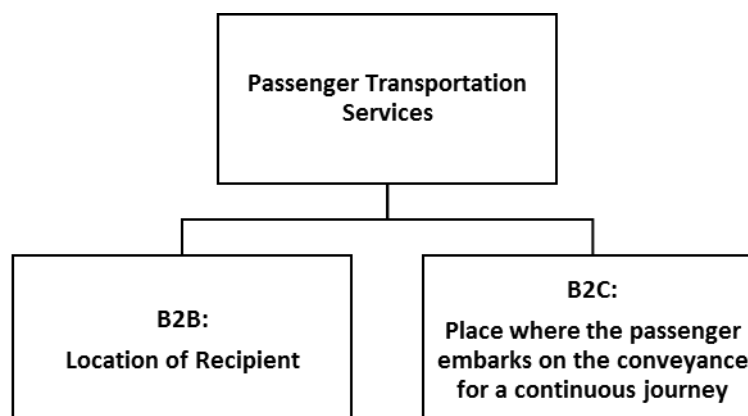

- (h) Services supplied on-board a conveyance, will be the first scheduled point of departure of such conveyance. Irrespective of whether the supplies are B2B or B2C, the POS is

determined based on the first scheduled point of departure. Please note that by this logic, it is possible that the place of supply is determined to be a place in the route which has passed crossed even before the passenger availing the service embarks the conveyance. The registered recipient receiving any services on board through its employees/ directors would lose the ITC on the said transaction in case the location of the registered recipient and the first schedule point of departure are in two different States.

- (i) Telecommunication services are provided in various forms and the place of supply will depend on the mode of providing the services. Where the services involve an in situ device installed to enable the service, the place of supply will be the location where such device is installed. This device may be a dish antenna, telephone line, etc. Where the services involve portable device, the place of supply will be the billing address if the same is on post-paid basis. Where it is on pre-paid basis, the place of supply will be the location of any intermediary who facilitates the supply or location where payment is received. Where none of the situations provide an appropriate location, then the place of supply will be the address-on-record of the recipient. If address is not available, then the location of supplier will be the place of supply.

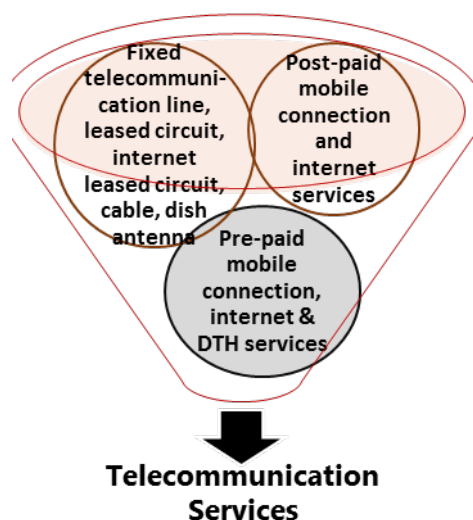

Rule 6 of IGST Rules provides that where the leased circuit is installed in more than one State/ UT and consolidated amount is charged for supply of such services, the value of services in each such State/ UT shall be determined in proportion to the number of points lying in the State/ UT. The number of points in a circuit shall be determined in the following manner:

- (i) in the case of a circuit between two points or places, the starting point or place of the circuit and the end point or place of the circuit will invariably constitute two points;

- (ii) any intermediate point or place in the circuit will also constitute a point provided that the benefit of the leased circuit is also available at that intermediate point.
- (j) Banking and financial services including stock broking services will be the location of the address-on-record of the recipient. And if address is not available, then the location of supplier will be the place of supply. The services referred in this provision are not services 'by' a banking or financial institution but services 'of' banking and financial services. As such, the service is to be examined and not the service provider. Classification of services to identify the applicability of this provision is an important exercise that is to be undertaken.
- (k) Insurance services supplied to a registered person will be the location of the recipient. When the recipient is not registered, the place of supply will be the address of location of the recipient of service on record of the supplier of services.
- (l) Advertisement services involving 'dissemination' of the material supplied to the Government or a statutory body will be the location of such dissemination. Where it is identifiable to a specific State, then that would be the place of supply and where it is disseminated over number of States, then a rule of proportion or any other reasonable basis is to be applied.

The proportion of value of advertisement services provided to Government, statutory body or local authority shall be determined in the manner laid down in Rule 3 of IGST Rules, 2017, as follows-

1. Advertisements in newspapers and publications: The amount payable for publishing in all the editions of a newspaper published in a State/ UT shall be the value of advertisement service attributable to such dissemination in each such State/ UT.
2. Printed material like pamphlets, leaflets, diaries, t-shirts and the like: Amount payable for the distribution of specified number of such printed material in a State/ UT shall be the value of service attributable to such dissemination in each such State/ UT.
3. Advertisement on hoardings (other than those on trains): The amount payable for the hoardings located in a State/ UT shall be the value of service attributable to such dissemination in each such State/ UT.
4. Advertisements on trains: Value of advertisement service attributable to each State/ UT shall be calculated in proportion to the length of the railway track in each State/ UT for that train.
5. Advertisements on the back of utility bills: Value of advertisement service attributable to each State/ UT shall be the amount payable for the advertisement on the bills pertaining to consumers having billing addresses in such State/ UT.

6. Advertisements on railway tickets: Value of advertisement service attributable to each State/ UT shall be calculated in proportion to the number of railway stations in such State/ UT.
 7. Advertisements on radio stations: Value of advertisement services attributable to each State/ UT shall be the amount payable towards the broadcast made in a State/ UT.
 8. Advertisements on television channels: Value of advertisement services attributable to each State/ UT in a month shall be calculated proportionately on the basis of number of channel viewership figures published by Broadcast Audience Research Council for the last week of the immediately preceding quarter. Where the channel viewership figures relate to a region comprising of more than one State/ UT, viewership figures for a State/ UT shall be calculated by applying the ratio of populations in those States/ UTs as per the last census.
 9. Advertisements in cinema halls: Amount payable to cinema halls in a State/ UT, shall be the value of advertisement services attributable to each State/ UT.
 10. Advertisements over the internet: Value of advertisement services attributable to each State/ UT in a month shall be calculated proportionately on the basis of number of internet subscriber figures published by TRAI for the last quarter of the immediately preceding financial year. Where the internet subscriber figures relate to a region comprising of more than one State/ UT, subscriber figures for a State/ UT shall be calculated by applying the ratio of populations in those States/ UTs as per the last census.
 11. Advertisements through SMS: Value of advertisement services attributable to each State/UT in a month shall be calculated proportionately on the basis of number of telecom subscriber figures published by TRAI for the immediately preceding quarter. Where the telecom subscriber figures relate to a telecom circle comprising of more than one State/ UT, subscriber figures for a State/ UT shall be calculated by applying the ratio of populations in those States/ UTs as per the last census.
- (m) Considering that place of supply has been so specifically covered in the various provisions discussed, it is to be borne and recollected that identifying the place of supply is for purposes of determining whether it is an inter-State supply or an intra-State supply. After much resistance to let go of the experience from erstwhile tax laws, it would dawn upon each of us to eschew seeking registration in every State where their services constitute a place of supply, but rather rely upon this section to open the doors to choose to effect inter-State supplies from one (or few) State only instead of multi-State registration that may be necessitated under erstwhile tax laws. Another important aspect especially when a recipient is a registered person which comes out on analysis of section 12 is that wherever the POS is based on location of the recipient, the ITC is intact and wherever the POS is not based on location of the recipient but based on

some other criterion as discussed above, then there is high probability of losing out on ITC in the hands of a registered person. Eg: Immovable property related services, admission to an event, services on board an aircraft etc.

Statutory provisions

13. Place of supply of services where location of supplier or location of recipient is outside India

(1) *The provisions of this section shall apply to determine the place of supply of services where the location of the supplier of services or the location of the recipient of services is outside India.*

(2) *The place of supply of services except the services specified in sub-sections (3) to (13) shall be the location of the recipient of services:*

Provided that where the location of the recipient of services is not available in the ordinary course of business, the place of supply shall be the location of the supplier of services.

(3) *The place of supply of the following services shall be the location where the services are actually performed, namely: —*

(a) *services supplied in respect of goods which are required to be made physically available by the recipient of services to the supplier of services, or to a person acting on behalf of the supplier of services in order to provide the services:*

Provided that when such services are provided from a remote location by way of electronic means, the place of supply shall be the location where goods are situated at the time of supply of services:

Provided further that nothing contained in this clause shall apply in the case of services supplied in respect of goods which are temporarily imported into India for repairs or for any other treatment or process and are exported after such repairs or treatment or process without being put to any use in India, other than that which is required for such repairs or treatment or process.⁵

(b) *services supplied to an individual, represented either as the recipient of services or a person acting on behalf of the recipient, which require the physical presence of the recipient or the person acting on his behalf, with the supplier for the supply of services.*

⁵ Inserted vide The Integrated Goods and Services Tax Amendment Act, 2018 w.e.f. 01.02.2019

- (4) *The place of supply of services supplied directly in relation to an immovable property, including services supplied in this regard by experts and estate agents, supply of accommodation by a hotel, inn, guest house, club or campsite, by whatever name called, grant of rights to use immovable property, services for carrying out or co-ordination of construction work, including that of architects or interior decorators, shall be the place where the immovable property is located or intended to be located.*
- (5) *The place of supply of services supplied by way of admission to, or organization of a cultural, artistic, sporting, scientific, educational or entertainment event, or a celebration, conference, fair, exhibition or similar events, and of services ancillary to such admission or organization, shall be the place where the event is actually held.*
- (6) *Where any services referred to in sub-section (3) or sub-section (4) or sub-section (5) is supplied at more than one location, including a location in the taxable territory, its place of supply shall be the location in the taxable territory.*
- (7) *Where the services referred to in sub-section (3) or sub-section (4) or sub-section (5) are supplied in more than one State or Union territory, the place of supply of such services shall be taken as being in each of the respective States or Union territories and the value of such supplies specific to each State or Union territory shall be in proportion to the value for services separately collected or determined in terms of the contract or agreement entered into in this regard or, in the absence of such contract or agreement, on such other basis as may be prescribed.*
- (8) *The place of supply of the following services shall be the location of the supplier of services, namely: —*
- (a) *services supplied by a banking company, or a financial institution, or a non-banking financial company, to account holders;*
 - (b) *intermediary services;*
 - (c) *services consisting of hiring of means of transport, including yachts but excluding aircrafts and vessels, up to a period of one month.*
- Explanation. —For the purposes of this sub-section, the expression, —*
- (a) *“account” means an account bearing interest to the depositor, and includes a non-resident external account and a non-resident ordinary account;*
 - (b) *“banking company” shall have the same meaning as assigned to it under clause (a) of section 45A of the Reserve Bank of India Act, 1934 (2 of 1934);*
 - (c) *“financial institution” shall have the same meaning as assigned to it in clause (c) of section 45-I of the Reserve Bank of India Act, 1934 (2 of 1934);*
 - (d) *“non-banking financial company” means, —*
 - (i) *a financial institution which is a company;*

- (ii) a non-banking institution which is a company and which has as its principal business the receiving of deposits, under any scheme or arrangement or in any other manner, or lending in any manner; or
- (iii) such other non-banking institution or class of such institutions, as the Reserve Bank of India may, with the previous approval of the Central Government and by notification in the Official Gazette, specify.
- (9) The place of supply of services of transportation of goods, other than by way of mail or courier, shall be the place of destination of such goods.
- (10) The place of supply in respect of passenger transportation services shall be the place where the passenger embarks on the conveyance for a continuous journey.
- (11) The place of supply of services provided on board a conveyance during the course of a passenger transport operation, including services intended to be wholly or substantially consumed while on board, shall be the first scheduled point of departure of that conveyance for the journey.
- (12) The place of supply of online information and database access or retrieval services shall be the location of the recipient of services.
- Explanation.—For the purposes of this sub-section, person receiving such services shall be deemed to be located in the taxable territory, if any two of the following non-contradictory conditions are satisfied, namely: —*
- (a) the location of address presented by the recipient of services through internet is in the taxable territory;
- (b) the credit card or debit card or store value card or charge card or smart card or any other card by which the recipient of services settles payment has been issued in the taxable territory;
- (c) the billing address of the recipient of services is in the taxable territory;
- (d) the internet protocol address of the device used by the recipient of services is in the taxable territory;
- (e) the bank of the recipient of services in which the account used for payment is maintained is in the taxable territory;
- (f) the country code of the subscriber identity module card used by the recipient of services is of taxable territory;
- (g) the location of the fixed land line through which the service is received by the recipient is in the taxable territory.
- (13) In order to prevent double taxation or non-taxation of the supply of a service, or for the uniform application of rules, the Government shall have the power to notify any description of services or circumstances in which the place of supply shall be the place of effective use and enjoyment of a service.

Extract of the IGST Rules

Rule 7. *The supply of services attributable to different States or Union territories, under sub-section (7) of section 13 of the said Act, in the case of services supplied in respect of goods which are required to be made physically available by the recipient of services to the supplier of services, or to a person acting on behalf of the supplier of services, or in the case of services supplied to an individual, represented either as the recipient of services or a person acting on behalf of the recipient, which require the physical presence of the recipient or the person acting on his behalf, where the location of the supplier of services or the location of the recipient of services is outside India, and where such services are supplied in more than one State or Union territory, shall be taken as being in each of the respective States or Union territories, and the proportion of value attributable to each such State and Union territory in the absence of any contract or agreement between the supplier of service and recipient of services for separately collecting or determining the value of the services in each such State or Union territory, as the case maybe, shall be determined in the following manner, namely:-*

- (i) *in the case of services supplied on the same goods, by equally dividing the value of the service in each of the States and Union territories where the service is performed;*
- (ii) *in the case of services supplied on different goods, by taking the ratio of the invoice value of goods in each of the States and Union territories, on which service is performed, as the ratio of the value of the service performed in each State or Union territory;*
- (iii) *in the case of services supplied to individuals, by applying the generally accepted accounting principles.*

Illustration-1: A company C which is located in Kolkata is providing the services of testing of a dredging machine and the testing service on the machine is carried out in Orissa and Andhra Pradesh. The place of supply is in Orissa and Andhra Pradesh and the value of the service in Orissa and Andhra Pradesh will be ascertained by dividing the value of the service equally between these two States.

Illustration-2: A company C which is located in Delhi is providing the service of servicing of two cars belonging to Mr. X. One car is of manufacturer J and is located in Delhi and is serviced by its Delhi workshop. The other car is of manufacturer A and is located in Gurugram and is serviced by its Gurugram workshop. The value of service attributable to the Union Territory of Delhi and the State of Haryana respectively shall be calculated by applying the ratio of the invoice value of car J and the invoice value of car A, to the total value of the service.

Illustration-3: A makeup artist M has to provide make up services to an actor A. A is shooting some scenes in Mumbai and some scenes in Goa. M provides the makeup services in Mumbai and Goa. The services are provided in Maharashtra and Goa and the value of the service in Maharashtra and Goa will be ascertained by applying the generally accepted accounting principles.

Rule 8. *The proportion of value attributable to different States or Union territories, under sub-section (7) of section 13 of the said Act, in the case of supply of services directly in relation to an immovable property, including services supplied in this regard by experts and estate agents, supply of accommodation by a hotel, inn, guest house, club or campsite, by whatever name called, grant of rights to use immovable property, services for carrying out or co-ordination of construction work, including that of architects or interior decorators, where the location of the supplier of services or the location of the recipient of services is outside India, and where such services are supplied in more than one State or Union territory, in the absence of any contract or agreement between the supplier of service and recipient of services for separately collecting or determining the value of the services in each such State or Union territory, as the case maybe, shall be determined by applying the provisions of rule 4, mutatis mutandis.*

Rule 9. *The proportion of value attributable to different States or Union territories, under sub-section (7) of section 13 of the said Act, in the case of supply of services by way of admission to, or organisation of a cultural, artistic, sporting, scientific, educational or entertainment event, or a celebration, conference, fair, exhibition or similar events, and of services ancillary to such admission or organisation, where the location of the supplier of services or the location of the recipient of services is outside India, and where such services are provided in more than one State or Union territory, in the absence of any contract or agreement between the supplier of service and recipient of services for separately collecting or determining the value of the services in each such State or Union territory, as the case maybe, shall be determined by applying the provisions of rule 5, mutatis mutandis.*

Relevant circulars, notifications, clarifications issued by Government:

1. Circular No. 2/ 1/ 2017-IGST, dated 27.09.2017 for clarification on the place of supply of satellite launch services by ANTRIX Corporation Ltd;
2. Notification No. 02/ 2017-Integrated Tax, dated 19.06.2017 notified to empower the Principal Commissioner of Central Tax, Bengaluru West to grant registration in case of OIDAR Services provided or agreed to be provided by a person located in non-taxable territory and received by a non-taxable online recipient.
3. Notification No. 4/ 2018-Integrated Tax, dated 31.12.2018 notified IGST (Amendment) Rules, 2018, to insert rules 4, 5, 6, 7, 8 and 9.

Related Provisions of the Statute:

Statute	Section / Rule	Description
CGST	Section 2(2)	Definition of address on record
CGST	Section 2(34)	Definition of conveyance
CGST	Section 2(56)	Definition of India
CGST	Section 2(93)	Definition of recipient
CGST	Section 9	Levy and collection of tax
IGST	Section 2(3)	Definition of continuous journey
IGST	Section 2(6)	Definition of export of services
IGST	Section 2(11)	Definition of import of services
IGST	Section 2(13)	Definition of intermediary
IGST	Section 2(14)	Definition of location of the recipient of services
IGST	Section 2(15)	Definition of location of the supplier of services
IGST	Section 2(17)	Definition of OIDAR services
IGST	Section 5	Levy and collection of tax
IGST	Section 7	Meaning of inter-State supplies
IGST	Section 8	Meaning of intra-State supplies
IGST	Section 10	Place of supply of goods other than goods imported into, or exported from India
IGST	Section 11	Place of supply of goods imported into, or exported from India
IGST	Section 12	Place of supply of services where location of supplier and location of recipient is in India
IGST	Section 14	Special provision for payment of tax by a supplier of OIDAR services

13.1 Analysis

Place of supply of services where either the supplier or recipient is located outside India will be determined in accordance with section 13 of the IGST Act. In other words, this provision applies for the determination of export of services as well as for import of services.

International supplies involving services are not verifiable similar to goods. GST, in certain cases, treats supplies involving goods as 'supply of services'. In such cases too, this provision will apply for determination of their export and import. Given the definition of export of services and import of services and on comparing them to goods, it will be evident that there is really no comparison. Matters such as location of supplier, location of recipient, currency of compensation, etc., assume importance in relation to services including goods that are treated as supply of services. In this background, we may analyze place of supply of services where either one – supplier or recipient – is located outside India.

Then the place of supply determined by application of this provision may be carried into the definition to determine whether the international supply meets the requirements to be regarded as 'export of services' or 'import of services'. This may be somewhat unnatural but that is the correct approach because location of

recipient outside India and payment in foreign currency are tests that the GST law does not appreciate. In this time and age of forex surplus, when two enterprises which are both located within India transacting in foreign currency is not impermissible.

New Delhi Authority for Advance ruling in case of M/s ROD RETAIL PVT LTD (2018-TIOL-08-AAR-GST) held that **Goods cannot be called to be exported, merely on crossing the Customs Frontiers of India.**

Supply of goods to the International passengers going abroad by the applicant from their retail outlet situated in the Security Hold Area of the Terminal-3 of IGI Airport may be taking place beyond Customs Frontiers of India as defined under Section 2(4) of the IGST Act, 2017.

However, the said outlet is not outside India, as claimed by the applicant but the same is within the territory of India as defined under Section 2(56) of the CGST Act, 2017 and Section

2(6) "export of services" means the supply of any service when

- (i) the supplier of service is located in India;
- (ii) the recipient of service is located outside India;
- (iii) the place of supply of service is outside India;
- (iv) the payment for such service has been received by the supplier of service in convertible foreign exchange; and
- (v) the supplier of service and recipient of service are not merely establishments of a distinct person in accordance with explanation 1 of section 8;

2(11) "import of service" means the supply of any service, where

- (i) the supplier of service is located outside India;
- (ii) the recipient of service is located in India; and
- (iii) the place of supply of service is in India;

2(27) of the Customs Act, 1962 and hence the applicant is not taking goods out of India and hence their supply cannot be called “export” under Section 2(5) of the IGST Act, 2017 or “zero rated supply” under Section 2(23) and Section 16(1) of the IGST Act, 2017. Hence applicant is required to pay GST at the applicable rates: AAR [para 28 to 36]

Place of supply of international supplies of services is as follows:

- (i) The general provision for determining the place of supply (POS) is that the POS will be the location of the recipient of the services; whereas, it will be the location of the supplier of services if the location of the recipient cannot be known without employing any extraordinary means. ‘Recipient’ is defined as the ‘person liable to pay consideration’ in section 2(93) of the CGST Act.
- (ii) It is important to note that this section only determines the POS. Merely because the POS is determined under this clause, the supply cannot be regarded as an export of service or an import of service.
- (iii) Specific provisions regarding place of supply that will apply in priority over the general provision will be as follows:
 - (a) POS of services that are ‘in respect of’ goods made available ‘by’ recipient ‘to’ supplier or persons representing supplier for performance of those services will be the location where the services are actually performed. It is worthwhile to note here that the goods must be made available only by the recipient and not his representative but whereas person to whom it is made available could be supplier or his representative. It is also noteworthy that the services to which this provision is to apply are not expressly listed here and left to an application of ‘made available for performance’ test to determine its applicability. Services that are supplied by remotely accessing the goods, the place of supply will be the location of the goods.

However, the said provisions will not apply in the case of services supplied in respect of goods which are temporarily imported into India for repairs or for any other treatment or process and are exported after such repairs or treatment or process without being put to any use in India, other than that which is required for such repairs or treatment or process. This amendment is made vide IGST (Amendment) Act, 2018, dated 29-Aug-2018 (effective 01.02.2019)

In cases where services are supplied at multiple locations, including a location in the taxable territory, POS is location in the taxable territory. Further, rule of proportion is to be applied in case the services are carried out in different States.

Rule 7 of IGST Rules provides that the value of services in each such State/ UT shall be determined in the following manner, namely:

- (i) in the case of services supplied on the same goods, by equally dividing the

value of the service in each of the States and Union territories where the service is performed;

- (ii) in the case of services supplied on different goods, by taking the ratio of the invoice value of goods in each of the States and Union territories, on which service is performed, as the ratio of the value of the service performed in each State or Union territory;
 - (iii) in the case of services supplied to individuals, by applying the generally accepted accounting principles.
- (b) Similar to the provisions of section 12(3), the POS in case of services 'directly in relation to' immovable property will be the location of such property. The expression 'in relation to' encompasses a wide range of services that have a proximate nexus with the immovable property. Such property may be a hotel, inn, guest house, homestay, club or campsite excluding houseboat. The end-use will not alter the applicability of this provision but the proximity of the property vis-à-vis the services. In cases where services are supplied at multiple locations, including a location in the taxable territory, POS is location in the taxable territory. The rule of proportion is to be applied in case the services are carried out in different States. Rule 8 of IGST Rules provides that the value of services in each such State/ UT shall be determined by applying the provisions of rule 4 of IGST Rules, *mutatis mutandis*.

Services required in construction activity which are received before being assigned to any particular site will not be determined by this provision but the general provision. For example, lease of construction equipment sent to a central warehouse before being deployed to any specific site.

- (c) Services of admission to a venue will be the location of the venue. The event that is organized may be cultural, artistic, sporting, scientific, education or entertainment or a celebration, conference, fair, exhibition or similar events including ancillary services. Services referred to here are admission or organizing the event at the venue. In cases where services are supplied at multiple locations, including a location in the taxable territory, POS is location in the taxable territory. Further, rule of proportion is to be applied in case the services are carried out in different States. Rule 9 of IGST Rules provides that the value of services in each such State/ UT shall be determined by applying the provisions of rule 5 of IGST Rules, *mutatis mutandis*.
- (d) Services in the following three cases deviates from the 'destination' principle and appoints the POS to be the location of the supplier:
 - Services by a banking company or a financial institution or NBFC –

- reference to services 'by' indicate that this specific provision will encompass all activities by such a service provider performed in their capacity as such.
- Intermediary services – defined in section 2(13) provide for a broad set of activities. It is important to examine whether the role of an intermediary is limited in any manner to marketing (proliferation of information to potential customers), pre-sale (submitting quotations) and post-sale (assisting in delivery, installation and after-sales support).
 - West Bengal Authority for Advance Ruling in the case of **Global Reach Education Services (P) Ltd. 2018 (4) TMI 808** held that promotion & marketing of various courses of foreign universities among prospective students in India is an intermediary service and does not constitute export of service. The Appellate Authority for Advance Ruling in the very same case 2018 (8) TMI 392 has confirmed the ruling of Authority for Advance Ruling.
 - Maharashtra Authority for Advance Ruling in the case of **Vserv Global (P) Ltd. TS-676-AAR-2018-NT** has held that back office administrative and accounting support services, payroll processing and maintenance of employee records, rendered by applicant to overseas client, a registered person incorporated in India, does not constitute an 'export of service'; Holds that, applicant arranges/facilitates supply of goods or services or both between overseas client and customers of overseas client, therefore, applicant is clearly covered and falls in 'intermediary' definition as contained u/s 2(13) of IGST Act, 2017.
 - Hiring of transport for a period upto one month – all services attendant to securing such limited duration. This excludes aircraft and vessel other than yacht.
- (e) POS of services of transportation of goods will be the destination of the goods, as opposed to the location where they are handed over for transportation as in case of supplies to unregistered persons in section 12(8). Transportation of goods may be by any mode, but not mail or courier. E.g.: A transporter registered in Kolkata may provide transportation service in respect of goods owned by a person in Nepal for delivery to another person in Assam. In such a case, although the service is supplied to a person located outside India, the supply will be a taxable supply and will not be considered to be an export of service.
- (f) POS of services of transportation of passenger will be the location where the passenger embarks on the conveyance for a continuous journey.

- (g) POS of services supplied on-board a conveyance, will be the first scheduled point of departure. Services are to be supplied during the journey and substantially consumed on-board. Any deviation from this condition will result in it getting classified under the general rule.
- (h) POS of services of OIDAR (online information and database access or retrieval) services will be location of recipient. Please refer to detailed discussion under section 14 on OIDAR services. Further, such recipient will be deemed to be situated in a taxable territory if any two of the following conditions are fulfilled:
- Address of recipient is in taxable territory;
 - Card of recipient that is used to pay for the services is issued in taxable territory;
 - Billing address is in taxable territory;
 - Internet protocol address in taxable territory;
 - Bank account of recipient used to make payment is in the taxable territory;
 - Country code of SIM card used by recipient is of taxable territory;
 - Fixed land line used by recipient is in taxable territory.
- (iv) Where there is any occasion for double taxation or non-taxation, the Central Government is empowered to notify the place of supply with respect to service of any specific description, wherein the place of supply will be the place of effective use and enjoyment of a service.

Statutory provisions

14. Special provision for payment of tax by a supplier of online information and database access and retrieval services

- (1) *On supply of online information and database access or retrieval services by any person located in a non-taxable territory and received by a non-taxable online recipient, the supplier of services located in a non-taxable territory shall be the person liable for paying integrated tax on such supply of services:*

Provided that in the case of supply of online information and database access or retrieval services by any person located in a non-taxable territory and received by a non-taxable online recipient, an intermediary located in the non-taxable territory, who arranges or facilitates the supply of such services, shall be deemed to be the recipient of such services from the supplier of services in non-taxable territory and supplying such services to the non-taxable online recipient except when such intermediary satisfies the following conditions, namely:—

<p>(a) <i>the invoice or customer's bill or receipt issued or made available by such intermediary taking part in the supply clearly identifies the service in question and its supplier in non-taxable territory;</i></p> <p>(b) <i>the intermediary involved in the supply does not authorize the charge to the customer or take part in its charge which is that the intermediary neither collects or processes payment in any manner nor is responsible for the payment between the non-taxable online recipient and the supplier of such services;</i></p> <p>(c) <i>the intermediary involved in the supply does not authorize delivery; and</i></p> <p>(d) <i>the general terms and conditions of the supply are not set by the intermediary involved in the supply but by the supplier of services.</i></p> <p>(2) <i>The supplier of online information and database access or retrieval services referred to in sub-section (1) shall, for payment of integrated tax, take a single registration under the Simplified Registration Scheme to be notified by the Government:</i></p> <p><i>Provided that any person located in the taxable territory representing such supplier for any purpose in the taxable territory shall get registered and pay integrated tax on behalf of the supplier:</i></p> <p><i>Provided further that if such supplier does not have a physical presence or does not have a representative for any purpose in the taxable territory, he may appoint a person in the taxable territory for the purpose of paying integrated tax and such person shall be liable for payment of such tax.</i></p>

Relevant circulars, notifications, clarifications issued by Government:

1. Notification No. 02/ 2017-Integrated Tax, dated 19.06.2017 notified to empower the Principal Commissioner of Central Tax, Bengaluru West to grant registration in case of OIDAR Services provided or agreed to be provided by a person located in non-taxable territory and received by a non-taxable online recipient;
2. Notification No. 10/ 2017-Integrated Tax (Rate), dated 28.06.2017 notifying services on which tax is payable on reverse charge basis.

Related Provisions of the Statute

Statute	Section / Rule	Description
CGST	Section 2(79)	Definition of non-taxable territory
CGST	Section 2(93)	Definition of recipient
IGST	Section 2(13)	Definition of intermediary
IGST	Section 2(15)	Definition of location of the supplier of services

IGST	Section 2(16)	Definition of non-taxable online recipient
IGST	Section 2(17)	Definition of OIDAR services
IGST	Section 5	Levy and collection of tax
IGST	Section 7	Meaning of inter-State supplies
IGST	Section 8	Meaning of intra-State supplies
IGST	Section 13	Place of supply of services where location of supplier or location of recipient is outside India
CGST	Rule 64	Form and manner of submission of return by persons providing OIDAR services

14.1 Introduction

This is a new transaction that is brought within the tax net only from 1 December, 2016 under Service Tax. The experience was more than encouraging as the amount of tax that has been collected from OIDAR is in a class of its own as regards taxable person and place of supply. Everything discussed until now must be given a go-bye to understand OIDAR more clearly.

14.2 Analysis

Online Information and database access or retrieval (OIDAR) is defined in a specific manner and may be simplified as follows:

2-step definition	Services (and not goods) supplied
	Delivered over continuous internet connectivity
2-step clarification	Involves minimal human intervention
	Impossible to ensure in absence of information technology

Six illustrations in the definition and some explanation about inclusions and exclusions:

Illustration	Includes	Excludes
Online advertising E.g. Google	<ul style="list-style-type: none"> Banner ads, pop-up ads, sponsored ads, etc. 	<ul style="list-style-type: none"> Preparation of content for online display like production, distribution and services of intermediaries Advertisement in newspaper, on posters and on television

<p>Cloud services E.g. Amazon Web services</p>	<ul style="list-style-type: none"> • Webhosting • Data warehousing 	<ul style="list-style-type: none"> • Software license issued by delivery of key number to remotely download via FTP
<p>E-books, movies, music, software and other intangibles E.g. Gaana.com and Netflix</p>	<ul style="list-style-type: none"> • Access to content permitted only 'online' even if stored in cache on user-end device but not allowing (official) permanent download 	<ul style="list-style-type: none"> • Downloadable e-books, movies, music, etc. which are available for offline viewing without any mandatory e-check of the user credentials • Content provided through dedicated user-end device for use of content • Supply of physical books, newsletter, newspaper or journals • Booking services or tickets to entertainment events, hotel accommodation or car hire • Educational or professional courses, where the content is delivered by a teacher over the internet or electronic network
<p>Online data or information E.g. LinkedIn, Taxindiaonline.com</p>	<ul style="list-style-type: none"> • Paid websites that provide information • Free sites with valuable information – if not treated as 'supply', ITC will not be available but if treated as 'supply, output tax will apply on like-kind-and-quality or cost-plus basis 	<ul style="list-style-type: none"> • Net banking where banking information is accessed online but merely incidental to offline banking transactions • Electronic commerce • Non-commerce and information portals • C2C portals
<p>Online supply of digital content E.g. Setmax online, YouTube</p>	<ul style="list-style-type: none"> • TV programs and movies supplied over the internet like monitored by issuing user login / password 	<ul style="list-style-type: none"> • Auditors report sent to client via email. It is merely a form in which the offline services are communicated. Services of

		<p>auditor is not the email of report issued but the opinion expressed about the financial position of the auditee</p> <ul style="list-style-type: none"> • Online order processing in respect of offline supply of goods • Services of lawyers and financial consultants who advise clients through email
Data storage E.g. Amazon	<ul style="list-style-type: none"> • Webservers – shared or dedicated, with/ without support, etc. 	<ul style="list-style-type: none"> • Lease of server with redundancy
Online gaming E.g. Zapak.com	<ul style="list-style-type: none"> • Live-gaming • Collaborative gaming 	<ul style="list-style-type: none"> • Computer/ mobile games to be used after downloading to user-end device

Thus, every transaction done over the internet is not e-commerce, everything delivered online is not OIDAR. The acid-test is to see 'always on' status of internet connectivity for the continuous supply of the underlying service. Mere use of internet for delivery of services that can otherwise be provided offline through some media like CD, pen-drive, etc. all though less-securely will not be OIDAR. The use of file-transfer-protocol (FTP) for delivery of software or music or games is only to ensure integrity in the delivery of these high-volume files and the use of internet for FTP does not become OIDAR.

To summarise, the following table depicts the ingredients prescribed in this section:

Supplier	Supplier of Services in non-taxable territory		
Recipient	B2C (non-taxable online recipient – NTOR)	Intermediary@ (deemed to be recipient and re-supplying to NTOR)	B2B# (all others)
Tax Payer	Overseas supplier	Intermediary	Recipient
Tax Payment	Forward Charge (through representative)	Forward Charge (through Intermediary)	Reverse Charge (by B2B Recipient)

@ issues invoice, authorizes charge for services, responsible to collect payment, authorizes delivery and controls terms and conditions of supply. Else, not an intermediary liable to pay

B2B may be registered taxable person for any output supply

Note: Non-taxable online recipient means any Government, local authority, governmental authority, an individual or any other person not registered and receiving online information and database access or retrieval services in relation to any purpose other than commerce, industry or any other business or profession, located in taxable territory.

For the purposes of the definition of 'non-taxable online recipient, "governmental authority" means an authority or a board or any other body:

- (i) set up by an Act of Parliament or a State legislature; or
- (ii) established by Government,

with 90% or more participation by way of equity or control, to carry out any function entrusted to a municipality under article 243W of the Constitution.

14.3 Comparative Review

In the erstwhile Service Tax law, a similar provision was inserted with effect from 01.12.2016.

14.4 Issues and concerns

1. The place of supply provisions, in certain cases, is determined to be a place outside the State in which the registered person has obtained registration – such as POS in case of services in relation to immovable property, admission to an event (including educational events), services on board a conveyance (say letting out a laptop on hire during the journey), banking services (where a single bank account is used for various GST registrations across States). In all such cases, the registered person is restricted from availing input tax credits even where the services have been availed in the course or furtherance of business.
2. Section 13(12) provides a deeming fiction whereby the location of the recipient of the OIDAR services is appointed to be in the taxable territory if any two of seven conditions are satisfied. For instance, say the debit card through which payment is made has been issued in Delhi (Condition in clause b), and the IP address is in Bangalore (Condition in clause f), there is no mechanism in place to appoint a single place of supply for the transaction. This could lead to issue as regards the apportionment of tax revenue between States.
3. A supply of OIDAR services by a supplier located in a non-taxable territory to a non-taxable online recipient in India is specifically excluded from a supply on which the recipient is required to discharge taxes on RCM basis. Accordingly, non-taxable online recipients are not required to obtain registration. The recipients being non-taxable persons, may not be in possession of any documents including the invoices issued by

the suppliers, since they are not mandated under any law to keep/ maintain such documents. This would make it extremely difficult for the revenue authorities to identify suppliers of OIDAR services located in a non-taxable territory, and even where identified, to track such suppliers.

Chapter 6

Refund of Integrated Tax to International Tourist

15. Refund of integrated tax paid on supply of goods to tourist leaving India

Statutory provisions

15. Refund of integrated tax paid on supply of goods to tourist leaving India

The integrated tax paid by tourist leaving India on any supply of goods taken out of India by him shall be refunded in such manner and subject to such conditions and safeguards as may be prescribed.

Explanation.—For the purposes of this section, the term “tourist” means a person not normally resident in India, who enters India for a stay of not more than six months for legitimate non-immigrant purposes.

15.1 Introduction

Outbound passengers leaving India accompanied by GST-paid goods received during their stay in India would result in India exporting its taxes and this is sought to be overcome.

15.2 Analysis

All outbound passengers carrying goods on which IGST has been paid are entitled to claim refund at the port-of-exit. It is likely that the verification will be simple and refund will be online. It is interesting to note that only ‘integrated tax’ is eligible for this refund. Also, as per proviso to section 8(1), all supplies to such an outbound tourist will always be treated as inter-State supply. The challenge to supplies-to-tourist’s is to identify an outbound tourist and charge IGST instead of CGST/SGST of the State where the goods are delivered. Please note that person seeking such refund must be a ‘tourist’ – who has entered India for genuine non-immigrant purposes. ‘Purpose’ of visit to India is key factor to be examined. Nationality, residency for tax purposes, etc. are irrelevant considerations. The provision of this section has not been made applicable as of now. Detailed inclusions and exclusions can be expected in due course but few illustrations may be considered.

“tourist” means a person not normally resident in India, who enters India for a stay of not more than six months for legitimate non-immigrant

Tourist will exclude:

- Persons resident in India (not limited to Indian passport holders) who are exiting India for any purpose whether for short duration or long duration or uncertain duration.

- Deputation of Indian resident to overseas diplomatic postings.
- Children born in India to foreign nationals during their stay in India.

Tourist will include the following:

- Crew of an international conveyance entering and exiting India within short duration even though not for purposes of tourism in India
- Foreign diplomatic visitors on official duty in India
- Foreign sports persons visiting India for participating in tournaments or training purposes
- Foreign journalist and camera crew visiting India in connection with their profession
- Foreign artists, musicians and actors visiting India to perform in shows or content production

Note: Provisions of this section are yet to be notified by the Government

Chapter 7

Zero Rated Supply

Statutory provisions

16. Zero Rated Supply

- (1) “Zero rated supply” means any of the following supplies of goods or services or both, namely: —
- (a) export of goods or services or both; or
 - (b) supply of goods or services or both to a Special Economic Zone developer or a Special Economic Zone unit.
- (2) Subject to the provisions of sub-section (5) of section 17 of the Central Goods and Services Tax Act, credit of input tax may be availed for making zero-rated supplies, notwithstanding that such supply may be an exempt supply.
- (3) A registered person making zero rated supply shall be eligible to claim refund under either of the following options, namely: —
- (a) he may supply goods or services or both under bond or Letter of Undertaking, subject to such conditions, safeguards and procedure as may be prescribed, without payment of integrated tax and claim refund of unutilized input tax credit; or
 - (b) he may supply goods or services or both, subject to such conditions, safeguards and procedures as may be prescribed, on payment of integrated tax and claim refund of such tax paid on goods or services or both supplied, in accordance with the provisions of section 54 of the Central Goods and Services Tax Act or the rules made thereunder.

Related provisions of the Statute

Section or Rule	Description
Section 2(47)	Definition of Exempt Supply (CGST)
Section 54	Refund of tax (CGST)
Section 2(5)	Definition of Export of Goods (IGST)
Section 2(6)	Definition of Export of Services (IGST)
Section 2(19)	Definition of Special Economic Zone (IGST)
Section 2(20)	Definition of Special Economic Zone Developer (IGST)
Section 2(23)	Definition of Zero Rate Supply (IGST)
Section 7	Inter-State supply

Notification No. 9/2017 – Central Tax dated 28.06.2017 - Seeks to bring into force certain sections of the CGST Act, 2017 w.e.f 01.07.2017

Notification No. 37 /2017 – Central Tax dated 04.10.2017 - Facility of LUT extended to all exporters / registered persons subject to conditions

NOTIFICATION No. 48/2017–Central Tax dated 18.10.2017 - Notified supplies, when the supply of goods shall be treated as deemed export under GST e.g. supplies against Advance Authorisation, to EOU, under EPCG scheme etc

Notification No. 49/2017-Central Tax dated 18.10.2017 - Evidences required to be produced by the supplier of deemed export supplies for claiming refund under rule 89(2)(g) of the CGST rules, 2017

Notification No. 41/2017--Integrated Tax (Rate) dated 23.10.2017 - IGST at the rate of 0.1% shall be payable on inter-State supply of taxable goods by a registered supplier to a registered recipient for export subject to specified conditions

C.B.E. & C. Advisory on Customs related matters on introduction of Goods and Services Tax regime dated 20.06.2017

Circular No. 1/1/2017-Compensation Cess dated 26.07.2017 - Clarification regarding applicability of section 16 of the IGST Act, 2017, relating to zero rated supply for the purpose of Compensation Cess on exports

Circular No. 2/1/2017-IGST dated 27.09.2017 - Clarification on supply of satellite launch services by ANTRIX Corporation Ltd

Circular No. 8/8/2017-GST dated 04.10.2017 - Clarification on issues related to furnishing of Bond/Letter of Undertaking for exports

Circular No. 14/14 /2017 – GST dated 06.11.2017 - Procedure regarding procurement of supplies of goods from DTA by Export Oriented Unit (EOU) / Electronic Hardware Technology Park (EHTP) Unit / Software Technology Park (STP) Unit / Bio-Technology Parks (BTP) Unit under deemed export benefits under section 147 of CGST Act, 2017

Circular No. 17/17/2017 – GST dated 15.11.2017 - Manual filing and processing of refund claims in respect of zero-rated supplies

Circular No. 18/18/2017-GST dated 16.11.2017 - Clarification on refund of unutilized input tax credit of GST paid on inputs in respect of exporters of fabrics

Circular No.24/24/2017-GST dated 21.12.2017 - Manual filing and processing of refund claims on account of inverted duty structure, deemed exports and excess balance in electronic cash ledger

Circular No. 37/11/2018-GST dated 15.03.2018 - Clarifications on exports related refund issues

Circular No. 40/14/2018-GST dated 06.04.2018 - Clarification on issues related to furnishing of Bond/Letter of Undertaking for exports

16.1 Introduction

Exports have been the area of focus in all policy initiatives of the Government for more than 30 years. Now with the Make in India initiative, exports continue to enjoy this special treatment because exports should not be burdened with domestic taxes. On the other hand, GST demands that the input-output chain not be broken and exemptions have a tendency to break this chain. Zero-rated supply is the method by which the Government has approached to address all these important considerations.

16.2 Analysis

Zero-rated supply does not mean that the goods and services have a tariff rate of '0%' but the recipient to whom the supply is made is entitled to pay '0%' GST to the supplier. In other words, as it has been well discussed in section 17(2) of the CGST Act that input tax credit will not be available in respect of supplies that have a '0%' rate of tax. However, this disqualification does not apply to zero-rated supplies covered by this section. It is interesting to note that section 7(5) (and even proviso to section 8(1)) declares that supplies 'to' or 'by' SEZ developer or unit will be treated as an inter-State supply. So, when two SEZ units or one SEZ developer and another SEZ unit supply goods or services to each other (among themselves within the zone) and the zone being located within the same State or UT, such supplies will always be inter-State supplies. But, it is important to note that this – being treated as inter-State supplies always – by itself does not mean that non-SEZ sales by SEZ unit will be liable to IGST in all cases. Please refer to the table below of supplies involving suppliers in the zone that is covered by the provisions of section 7(5) and proviso to section 8(1):

Supply 'by'	Supply 'to'
SEZ unit	Outside India
SEZ unit	Another SEZ unit
SEZ developer	SEZ unit
Non-SEZ unit	SEZ unit
SEZ unit	Non-SEZ unit
Non-SEZ unit	SEZ developer
SEZ developer	Non-SEZ unit

Note: Physical location within the political boundaries of a State are irrelevant

The intention of government not to burden the export with tax could be achieved either by allowing not to charge tax on the exports of goods/services and claim the refund of input tax credits of taxes paid on inward supplies or by allowing the refund of tax charged on the exports made. Both these alternatives have been enabled in this section. Zero-rated supplies may be undertaken in either of the following ways:

Taxable person to avail input tax credit used in making outward supply of goods or service or both and make zero-rated supply-

<ul style="list-style-type: none"> Without any payment of IGST on such outward supply by executing LUT (Letter of Undertaking) or bond (dispensed off vide notification 37/2017-Central tax) 	<ul style="list-style-type: none"> Make payment of IGST on the outward supply by debiting 'electronic credit ledger' but without collecting this tax from the recipient
<ul style="list-style-type: none"> Claim refund of input tax credit used in the outward supply 	<ul style="list-style-type: none"> After completing the outward supply, claim refund of the IGST so debited (unjust enrichment having been duly satisfied)
Subject to fulfilment of all associated conditions and safeguards that may be prescribed in either case	

- Physical exports are well understood due to the vast experience from Customs Act. Physical exports, as discussed under section 11, are not determined or defined by realization of foreign exchange (unlike export of services). SEZ is defined in section 2(20) to have the meaning from 2(g) of SEZ Act, 2005. Supply of goods by SEZ to non-SEZ area is governed by Customs Act in terms of Rule 47 in Chapter V of SEZ Rules, 2006. Accordingly, although the supply is 'treated as inter-State supply of goods' in terms of section 7(5), no tax is to be charged by the SEZ supplier but instead, the non-SEZ recipient is to pay IGST at the time of assessment of the bill of entry filed for such goods in terms of Customs Tariff Act, 1975 duly amended by the Taxation Laws Amendment Act, 2017 wherein section 3 of the Customs Tariff Act, 1975 has been substantially altered to enable imposition of additional customs duties only on goods not subsumed into GST and for the imposition of IGST on goods subsumed into GST by sub-section 7, 8 and 9. However, with respect to supply of services by SEZ to non-SEZ area, though not prohibited, is not expressly dealt with by this Chapter V of SEZ Rules as to the taxes/ duties applicable. To draw the relevant inference, one should observe the definition of India as per section 2(56) of CGST Act. It has been defined to mean territory of India as referred to in Article 1 of the Constitution. SEZ units are also covered within above definition of India. As the CGST and IGST Act extend to whole of India, it could be said to be applicable to SEZ unit also and thereby making SEZ unit as falling within definition of taxable territory. If this view is taken, it may very simply be an inter-State supply of services liable to payment of IGST on forward charge basis by the SEZ unit because there is no reference in IGST to borrow the operation of section 53 from SEZ Act. Reverse charge Notification No. 10/2017- Integrated Tax (Rate) dated 28-Jun-17 covers any services supplied by any person who is located in a non-taxable territory to any person located in the taxable territory under reverse charge mechanism. SEZ unit may be said to be falling within definition of taxable territory and liable to tax under forward charge.

Accordingly, certain examples have been discussed below:

These provisions of zero-rated supplies are introduced in the statute on the basis of the prevalent Central Excise and Service Tax laws. It is widely believed that introduction of this provision will alleviate the difficulty of a supplier who exempts goods or services or both in terms of export competitiveness. This provision also specifically expresses that taxes are not exported. Care must be exercised that while paying taxes, such taxes are not collected from the recipient of goods or services or both. This would result in unjust enrichment.

The following illustrations may be considered:

Table A – Physical Exports

Zero-rated supply (Physical exports)	Option A (without payment of IGST)	Option B (with payment of IGST)
ABC from Chennai supplies goods required by PQR in Delhi to effect exports to Germany	<ul style="list-style-type: none"> • ABC to charge IGST (Rs.100/-) to PQR • PQR to avail input tax credit • PQR to issue invoice for €15 • PQR to ensure no IGST is charged in the Euro invoice • PQR to bring proof-of-export and satisfy all other conditions prescribed • PQR to claim refund of input tax credit of Rs.100/- being maximum amount related to the outward export supply • Such refund to be claimed by filing Form GST RFD-01 	<ul style="list-style-type: none"> • ABC to charge IGST (Rs.100/-) to PQR • PQR to avail input tax credit • PQR to issue, invoice for €15 • IGST to be charged on tax invoice issued in INR meant only for the purpose of GST. • PQR to debit electronic credit ledger with IGST applicable of Rs.180/- on the export (assume sufficient balance in credit ledger from all other inputs, input service and capital goods) • PQR to bring proof-of-export and satisfy all other conditions prescribed • Refund of Rs. 180/- to be allowed on automatic processing of shipping bill by Customs once GSTR-3 and EGM is filed (Rule 96 of the CGST Rules to be followed)

<p>XYZ from Delhi supplies services required by PQR in Delhi to effect export of services to USA</p>	<ul style="list-style-type: none"> • XYZ to charge CGST/SGST (Rs.250/-) to PQR • PQR to avail input tax credit • PQR to issue invoice for \$20 • PQR to ensure no IGST is charged in the USD invoice • PQR to bring proof-of-export and satisfy all other conditions prescribed including realisation of consideration in foreign currency • PQR to claim refund of input tax credit of Rs.250 being maximum amount related to the outward export supply by filing refund claim in Form GST RFD-01 	<ul style="list-style-type: none"> • XYZ to charge CGST/SGST (Rs.250/-) to PQR • PQR to avail input tax credit • PQR to issue invoice for \$20 • IGST to be charged on tax invoice issued in INR meant only for the purpose of GST. PQR to debit electronic credit ledger with IGST applicable of Rs. 300/- on the export • PQR to bring proof-of-export and satisfy all other conditions prescribed • PQR to claim refund of IGST paid in respect of export (though actual relatable credit is much higher at Rs.250/-)
--	--	--

Table B – Supply ‘to’ SEZ

Zero-rated supply (supply ‘to’ SEZ)	Option A (without payment of IGST)	Option B (with payment of IGST)
<p>ABC from Hyderabad supplies goods required by PQR in Kolkata for onward supply to XYZ in Kolkata-SEZ (for use in authorized operations)</p>	<ul style="list-style-type: none"> • ABC to charge IGST (Rs.100/-) to PQR • PQR to avail input tax credit • PQR to supply goods to XYZ (SEZ) for Rs.1,500/- • PQR to ensure no IGST is charged in invoice to XYZ • PQR to obtain proof-of-admittance from SEZ 	<ul style="list-style-type: none"> • ABC to charge IGST (Rs.100/-) to PQR • PQR to avail input tax credit • PQR to issue invoice to XYZ (SEZ) for Rs.1,500/- • PQR to debit electronic credit ledger with IGST applicable of Rs.270/- (say, 18%) on the export

	<p>officer and satisfy all other conditions prescribed</p> <ul style="list-style-type: none"> • PQR to claim refund of input tax credit of Rs.100 being maximum amount related to the supply to XYZ (SEZ) 	<p>(assume sufficient balance in credit ledger from all other inputs, input service and capital goods)</p> <ul style="list-style-type: none"> • PQR to obtain proof-of-admittance from SEZ officer and satisfy all other conditions prescribed • PQR to claim refund of Rs.270 debited in electronic credit ledger in respect of supply to XYZ (SEZ) • SEZ unit not to avail the credit of IGST paid by PQR [Rule 89 (2)] of CGST Rules
<p>XYZ from Surat supplies goods required by PQR in Rajkot for onward supply of services to MNO in Ahmedabad-SEZ (for use in authorized operations)</p>	<ul style="list-style-type: none"> • XYZ to charge CGST/SGST (Rs.250/-) to PQR • PQR to avail input tax credit • PQR to supply services to MNO (SEZ) for Rs.2,000/- • PQR to ensure no IGST (even though within same State, it is inter-State supply) is charged in invoice to MNO • PQR to obtain proof-of-receipt-of-service (as specified by SEZ officer) and satisfy all other conditions (proviso to Rule 89 of Refund Rules) • PQR to claim refund of input tax credit of Rs.250/- being maximum amount related to the supply to MNO (SEZ) 	<ul style="list-style-type: none"> • XYZ to charge CGST/SGST (Rs.250/-) to PQR • PQR to avail input tax credit • PQR to issue invoice to MNO (SEZ) for Rs.2,000/- • PQR to debit electronic credit ledger with IGST applicable of Rs.240/- (say, 12%) on the export • PQR to obtain proof-of-receipt-of-service (as specified by SEZ officer) and satisfy all other conditions (proviso to Rule 89 of CGST Rules) • PQR to claim refund of Rs.240/- debited in electronic credit ledger in respect of supply to MNO (SEZ)

Table C – Supply ‘by’ SEZ

Zero-rated supply	Option A	Option B
Supply between two SEZ units:	(without payment of IGST)	(with payment of IGST)
<p>ABC-SEZ in Indore supplies goods manufactured in the zone to PQR-SEZ in Mumbai (for use in authorized operations)</p> <p>Supply by ABC-SEZ to PQR-SEZ is inter-State supply (whether in same State/ UT or in different States/ UTs)</p>	<ul style="list-style-type: none"> • Goods or services received by ABC-SEZ from various suppliers will be as stated in Table B (above) • ABC-SEZ to issue invoice to PQR-SEZ without any IGST • No input tax credit that needs to be availed by PQR-SEZ • ABC-SEZ to obtain proof-of-admittance from SEZ officer with assistance of PQR-SEZ and satisfy all other conditions prescribed • There is no refund to be claimed either by ABC-SEZ or PQR-SEZ as no IGST has been paid in this chain 	<ul style="list-style-type: none"> • Goods or services received by ABC-SEZ from various suppliers will be as stated in Table B (above) • ABC-SEZ to issue invoice to PQR-SEZ. IGST to be charged but not collected from PQR-SEZ. • ABC-SEZ to debit electronic credit ledger with IGST applicable of Rs.240/-. • ABC-SEZ to obtain proof-of-admittance from SEZ officer with assistance of PQR-SEZ and satisfy all other conditions prescribed • ABC-SEZ to claim refund claim of Rs. 240/- and debit it in electronic credit ledger in respect of supply to PQR (SEZ)
<p>XYZ-SEZ developer in Noida provides lease of premises to MNO-SEZ for its authorized operations</p> <p>Note: This applies to all supplies by developer to unit – premises lease, premises maintenance and other value added</p>	<ul style="list-style-type: none"> • Goods or services received by XYZ-SEZ from various suppliers will be as stated in Table B (above) • XYZ-SEZ to issue invoice to MNO-SEZ without any IGST • No input tax credit that needs to be availed by 	<ul style="list-style-type: none"> • Goods or services received by XYZ-SEZ from various suppliers will be as stated in Table B (above) • XYZ-SEZ to issue invoice to MNO-SEZ. IGST to be charged but not collected from MNO-SEZ. • XYZ-SEZ to debit

services	<p>MNO-SEZ</p> <ul style="list-style-type: none"> • XYZ-SEZ to obtain proof-of-receipt of service from SEZ officer with assistance of MNO-SEZ and satisfy all other conditions prescribed • There is no refund to be claimed either by XYZ-SEZ or MNO-SEZ as no IGST has been paid in this chain 	<p>electronic credit ledger with IGST applicable of Rs.400/-.</p> <ul style="list-style-type: none"> • XYZ-SEZ to obtain proof-of-receipt of service from SEZ officer with assistance of MNO-SEZ and satisfy all other conditions prescribed • ABC-SEZ to claim refund claim of Rs.400/- and debit it in electronic credit ledger in respect of supply to PQR (SEZ)
Supply by SEZ into non-SEZ:		
<p>ABC-SEZ in Gurugram supplies goods to PQR (non-SEZ unit) in Delhi (with necessary non-SEZ supply permission obtained by ABC from SEZ officer)</p> <p>Note: All supplies 'by' SEZ is treated as inter-State supply</p>	<ul style="list-style-type: none"> • ABC-SEZ to supply goods to PQR • IGST to be collected by ABC-SEZ to PQR • ABC to file bill of entry for import of goods from SEZ to non-SEZ • Bill of entry filed by ABC will be assessed for BCD + IGST • PQR can then claim input tax credit of IGST paid on in bill of entry • PQR to utilize IGST credit 	<ul style="list-style-type: none"> • Nothing to discuss in this option

All refunds are subject to the 'due process' prescribed in section 54 of CGST Act read with Chapter X of CGST Rules including verification of unjust enrichment. Care must be taken not to include the refundable amount in the price charged to overseas customer. This may be checked by looking into:

- If the refundable amount is expensed directly or carried forward as a current asset
- If overseas customer is given credit in any subsequent invoice to the extent of refund
- If the reversal of refundable amount from the credit ledger is charged to P&L or not

Also, all invoices to have a declaration as to –

- Export of goods or services on payment of IGST;
- Export of goods or services without payment of IGST;
- Supplies to a SEZ developer or unit on payment of IGST; or
- Supplies to a SEZ developer or unit without payment of IGST.

Further, all supplies to SEZ developer or unit being zero-rated does not mean that the entire company can enjoy this form of *ab initio* exemption. For example, Company incorporated in Delhi may have established a SEZ unit in Jaipur. All goods and services supplied to SEZ in Jaipur will enjoy the *ab initio* exemption but the goods and services supplied to Delhi will be liable to tax. Now, if the incorporated address of the Company were also in Jaipur and inside the zone, the Company must be cautious to differentiate the supplies that are not related to the authorized operations in the zone but related to the other affairs of the Company and instruct the suppliers to charge applicable GST on such non-SEZ supplies. It is for this reason that proviso to Rule 8(1) of the CGST Rules provides for SEZ unit to secure separate registration as a distinct business vertical, apart from the rest of the Company. Complete use of this zero-rated exemption will invite recovery action against the SEZ developer or unit. The supplier who supplied as a zero-rated supply is not responsible for this misuse because the SEZ developer or unit would have issued the GSTIN of the zone. Further, in case GST is paid on the non-zone operations of the Company and these costs are included in the export billing, there may be some aspects to be taken care of in case post-export refund of this GST paid is sought to be claimed. Please note that all supplies to SEZ developer or unit alone is treated as an inter-State supply but the supply to the Company relating to non-SEZ activities will continue to be inter-State or intra-State supply as the case may be. With all information, available online through GSTN, misuse is not difficult to identify. Care must be taken to diligently use the provisions of zero-rated supply.

With regard to 'bill to-ship to' transactions, it is important to mention that though the supply may be 'billed to' person located outside India (for exports) or inside zone (for SEZ supplies), where the supplies are 'shipped to' must be clearly identified in order to qualify for the benefit under this section. It is not that 'exports' are zero rated but 'supply by way of export' are zero rated. There is a lot of difference between these two expressions. With the difference between these two expressions having been discussed in the context of sections 11, it is sufficient to mention here that 'supply by way of export' is a subset of 'exports'. And in order to claim benefit of zero rating under this section, it is important to examine an 'export' to meet the requirements of 'supply by way of export'. In other words, both the 'bill to' and 'ship to' locations must be to the destination – outside India (for exports) or inside zone (for SEZ supplies) – in order to qualify for zero rating benefit. This principle applies equally to supply of goods as well as supply of services for exports.

The above view is best explained through an illustration. Say, a contractor is awarded civil works by a zone-developer and this contractor buys cement from a trader with instructions to deliver the cement directly at site (zone). Now, the supply of cement by trader is 'ship to: zone' but 'bill to: contractor'. Question that arises is, can the cement trader claim zero-rating benefit? Answer is, no, because the 'bill to' and 'ship to' locations must both be in the zone to satisfy the requirements of Section 16 of the IGST Act and Rule 89 of the CGST Rules.

Even if the goods or service which are either exported or supplied to SEZ unit developer are exempted goods or services, input tax credit is still available for making such zero rated supplies. The requirement to reverse ITC in relation to exempted supplies is not warranted if it is zero rated.

16.3 Procedure for zero-rated supply of goods or services:

16.3.1. Export of goods or services without payment of Integrated Tax

Exporter of goods is eligible to export goods or services without payment of IGST by complying with following procedure

(Note: Same procedures have to be followed by SEZ in respect to export of goods without payment of tax.)

A. Furnishing of Letter of undertaking:

- i. *Notification 37/2017 dated 4.10.2017* of Central Tax provides for the conditions and safeguards for export of goods or services without payment of IGST which supersedes notification 16/2017 dated 4.7.2017 of Central tax
- ii. Conditions and safeguards for issuing letter of undertaking: all registered persons who intend to supply goods or services for export without payment of integrated tax shall be eligible to furnish a Letter of Undertaking in place of a bond except those who have been prosecuted for any offence under the Central Goods and Services Tax Act, 2017 (12 of 2017) or the Integrated Goods and Services Tax Act, 2017 (13 of 2017) or any of the existing laws in force in a case where the amount of tax evaded exceeds two hundred and fifty lakh rupees;
- iii. As per Circular No.40/14/2018GST dated April 6, 2018, the registered person is required to fill and submit Form GST RFD-11 on the common portal. An LUT is deemed to be accepted as soon as an acknowledgement for the same, bearing Application Reference Number (ARN) is generated online. It is further clarified in the aforesaid Circular that no document needs to be physically submitted to the Jurisdictional office for acceptance of LUT.
- iv. Letter of undertaking would be executed by the working partner, the Managing Director or the Company Secretary or the proprietor or by a person duly authorised by such working partner or Board of Directors of such company or proprietor.

- vi. Existing LUT would be valid for the whole of the financial year in which it is tendered. Therefore, every registered person should apply for fresh LUT at the start of each financial year i.e, 1st of April.
- vii. where the registered person fails to pay the tax due along with interest, as specified under sub-rule (1) of rule 96A of Central Goods and Services Tax Rules, 2017, within the period mentioned in clause (a) or clause (b) of the said sub-rule, the facility of export without payment of integrated tax will be deemed to have been withdrawn and if the amount mentioned in the said sub-rule is paid, the facility of export without payment of integrated tax shall be restored.
- viii. Where a supplier wishes to effect zero-rated supplies without payment of IGST, the supplier is required to furnish the LUT in Form GST RFD – 11. In terms of Section 16, the LUT should be filed before effecting the zero-rated supplies in order to claim an exemption from payment of taxes. Rule 96A of the CGST / SGST Rules, 2017 provides that LUT should be furnished prior to effecting export of goods / services. It is inferred that if the LUT is not furnished prior to effecting zero rated supplies, the supplier cannot claim exemption on zero rated supplies. In this regard, the Board has issued circular vide No. 37/11/2018 – GST dated 15.03.2018 wherein it is clarified that the substantial benefits of zero rating supplies should not be denied if it is established that the goods or services have been exported in terms of the relevant provisions.

C. Furnishing of RFD-11

- i. Rule 96A of CGST Rules provides that any registered person availing option to export goods or services without payment of IGST has to furnish letter of undertaking prior to commencement of export in Form RFD-11. Format of RFD-11 is provided in CGST Rules 2017.
- ii. Circular 26/2017 of customs dated 01-07-2017 provides that procedure prescribed under Rule 96A needs to be followed for export of goods or services w.e.f. 01-07-2017.
- iv. Condition to comply:
 - a. In case of goods: good to be exported within 3 months from date of issue of invoice
 - b. In case of services: Payment to be received in convertible foreign exchange within 1 year from date of invoice
- v. Bond or LUT has to be furnished along Form GST RFD-11 binding himself that tax along with interest @18% would be liable to paid by him;
 - a. In case of goods: within 15 days after completion of 3 months on failure to export such goods.
 - b. In case of services: within 15 days of completion of 1 year if such payment is not received in accordance with point (iv).

D. Tax Invoice:

- i. Exporters would be required to raise tax invoice with prescribed particulars mentioning "Supply meant for export under bond or Letter of Undertaking without payment of integrated tax".
- ii. No tax needs to be charged on the invoice in this case.
- iii. Tax invoice may be in addition to other export documents provided to customer.

E. Sealing (in case of goods):

Till mandatory self-sealing is operationalized, sealing of containers shall be done under the supervision of the central excise officer having jurisdiction over the place of business where the sealing is required to be done.

F. Shipping Bill (in case of goods):

- i. Shipping Bill format has been revised by customs to capture GST related details.
- ii. Shipping bill to be prepared in Form SB-I.
- iii. In case of export of duty free goods shipping bills has to be prepared in Form SB-II.
- iv. Shipping bill needs to be issued in 4 copies (Original, Drawback purpose, Department purpose and export promotion)

G. Refunds

Refund of taxes in respect of accumulated input tax credit has to be claimed by following procedure prescribed by section 54 of CGST Act read with Chapter X of CGST Rules, 2017.

- Time limit: 2 years from the relevant date
- Method of filing: Form GST RFD-01A in online portal of GST in format provided in CGST Rules 2017. Further, the requisite documents need to be physically submitted with the relevant jurisdictional officer for processing of the claim.
- Provisional refund: 90% of refund claim to be sanctioned within 7 days subject to certain conditions Balance 10% within 60 days on verification of documents by proper officer.
- Details of Bank Realization Certificate (BRC) or Foreign Inward Remittance Certificate (FIRC) needs to be provided along with details of export invoice while filing Form GST RFD-01

16.3.2. Export of goods or services with payment of Integrated Tax

The procedures to be followed under this option is as follows:

(Note: Same procedures have to be followed by SEZ in respect to export of goods with payment of tax.)

A. Commercial Invoice: Exporter can issue 2 sets of invoices to have a smooth flow of transactions with his foreign customers.

- i. Commercial invoice can be issued (along with tax invoice) without showing tax amount.

- ii. Points to keep in mind while following practice of issuing commercial invoice along with tax invoice:
 - Total value of both the invoices should be equal.
 - Every commercial invoice should have a corresponding tax invoice.

B. Tax Invoice:

- i. Exporters would be required to raise tax invoice with prescribed particulars mentioning "Supply meant for export on payment of integrated tax".
- ii. Applicable IGST needs to be charged on the invoice in this case.
- iii. Tax invoice would be in addition to other export documents provided to customer.

C. Sealing/ Shipping Bill: same as referred above in 16.3.1.

D. Refunds:

- a. In case of goods: Rule 96 of CGST Rules provides for the mechanism for refund of tax in case of export of goods with payment of tax.
 - i. Shipping bill filed with custom would be considered as application for refund of integrated tax paid on export of goods.
 - ii. Refund application shall be valid only when:
 - (a) Filing of export manifest/export report by person in charge of the conveyance carrying the export goods.
 - (b) Furnishing of valid return in Form GSTR-3 or Form GSTR-3B, whichever is applicable, by the applicant.
 - iii. GST and custom portal would be inter-linked in which custom portal would electronically confirm to GST portal about movement of goods outside India.
 - iv. Upon the receipt of the information regarding the furnishing of a valid return in FORM GSTR-3 or FORM GSTR-3B, as the case may be from the common portal, the system designated by the Customs shall process the claim for refund and an amount equal to the integrated tax paid in respect of each shipping bill or bill of export shall be electronically credited to the bank account of the applicant mentioned in his registration particulars and as intimated to the Customs authorities.
 - v. Withheld of refund: Refund can be withheld upon receipt of request from Jurisdictional Commissioner or where customs provisions are violated.
 - vi. The exporter would not be eligible for refund in case of notified goods where refund of integrated tax is provided to Government of Bhutan.
- b. In case of services: Refund of taxes in respect of tax paid has to be claimed by following procedure prescribed by section 54 of CGST Act read with Chapter X of CGST Rules.
 - Time limit: 2 years from the relevant date

- Method of filing: Form GST RFD-01A on online portal of GST in format provided in CGST Rules 2017. Further, the requisite documents need to be physically submitted with the relevant jurisdictional officer for processing of the claim. • Provisional refund: 90% of refund claim to be sanctioned within 7 days subject to certain conditions. Balance 10% within 60 days on verification of documents by proper officer.
- Details of Bank Realization Certificate (BRC) or Foreign Inward Remittance Certificate (FIRC) needs to be provided along with details of export invoice while filing Form GST RFD-01.

16.4 Procedure for supplies to SEZ unit/ SEZ developer:

Same procedure as referred above in 16.3 can be followed in following cases:

- (a) Supply to SEZ without payment of integrated tax
- (b) Supply to SEZ with payment of integrated tax.

(Note: Same will be followed in cases the above supplies are made by an SEZ unit or SEZ developer)

16.5 Issues and concerns:

1. In terms of Section 16 of the IGST Act, 2017 in case of supplies to SEZ developer or SEZ unit / exports in terms of Section 2(5) or 2(6) of the IGST Act, the supplier can either effect supplies on payment of tax, which can subsequently be claimed as a refund. Alternatively, the supplier may effect the supplies without payment of tax under a bond or LUT and is entitled to claim refund of the input tax credit used in effecting such supplies. In this regard, attention is drawn to the fact that the supplier would be disentitled from claiming refund of IGST paid on such supplies effected on payment of IGST (without LUT), if the supplier recovers the amount of tax from the recipients.
2. The time of supply provisions require that tax is remitted on receipt of advances, in respect of supply of services. Consider a case where a supplier of services has received an advance from a recipient located outside India, in respect of services to be exported. In this regard, it is important to understand whether the LUT should be obtained prior to receipt of advance payment for supply of services, or if it would be sufficient for the registered person to obtain the same before effecting the supply. Rule 96A of the CGST / SGST Rules, 2017 specifies that LUT should be furnished prior to export of services. In terms of Rule 96A, the LUT in Form GST RFD – 11 should be furnished to undertake to remit the applicable taxes along interest if the consideration in convertible foreign exchange is not received within one year from the date of issue of invoice. Accordingly, it can be discerned that LUT is not required to be furnished where the consideration in convertible foreign exchange is received in advance. Further, attention is drawn to Circular No. 37/11/2018 – GST dated 15.03.2018 wherein it is clarified that the substantial benefits of zero-rating supplies should not be denied if it is

established that the goods or services have been exported in terms of the relevant provisions.

3. Any variation in foreign currency subsequent to the date of time of supply in case of imports and export transaction would not be relevant in the determination of value of taxable supply under section 15. The age old CBEC Circular with the subject "Whether rebate-sanctioning authority may re-determine the amount of rebate in certain cases — Instructions regarding" dated 3.2.2000 also highlight this fact. The C.B.E. & C. has then clarified in their Circular No. 510/06/2000-Cx, dated 3-2-2000 issued from F. No. 209/29/99-Cx-6 that the rebate sanctioning authority is not required to reassess the value for the export and the value assessed by the range officer on ARE-1 at the time of export has to be accepted. Further, this duty is also not affected by the less realization of export proceeds owing to exchange rate fluctuation and the duty and value has to be on the date, time and place of removal and the exchange rate on that date alone would be applicable. In other words any exchange gain or loss will remain outside the purview of GST law.
4. The Authority for Advance Rulings, Delhi, in an issue relating to taxability of the supplies effected by duty-free shops located in the premises of an international airport to the international out-bond passengers has held that such supplies will not qualify as zero-rated supplies. The goods can be said to be exported only when the goods cross the territorial waters of India and cannot be considered to be exported merely on crossing the Customs Frontiers of India – *Refer advance ruling in the case of M/s. Rod Retail Private Limited reported in 2018 (4) TMI 938 – AAR New Delhi.*

16.6 Comparative Review

The concept of zero-rated supplies is there in the VAT laws with credit benefit and refund. As far as Central Excise law is concerned there is a rebate mechanism in place. That apart the accumulated unutilised credit is available as refund to the exporters of services/ goods under rule 5 of the Cenvat Credit Rules, 2004.

16.7 Related Provisions of the Statute:

Statute	Section / Sub-Section	Description	Remark
CGST	17(2)	Apportionment of credit and blocked credits	Restrictions on credit attributable to exempt supplies.
IGST	2(23)	Zero-rated supply	Adopts the provisions of section 16 of IGST Act

Chapter 8

Apportionment of Tax and Settlement of Funds

17. Apportionment of tax and settlement of funds
18. Transfer of input tax credit
19. Tax wrongfully collected and paid to Central Government or State Government

Statutory Provisions- Effective from 1st July, 2017 to 31st January, 2019

17 Apportionment of tax and settlement of funds

- (1) *Out of the integrated tax paid to the Central Government, —*
- (a) *in respect of inter-State supply of goods or services or both to an unregistered person or to a registered person paying tax under section 10 of the Central Goods and Services Tax Act;*
 - (b) *in respect of inter-State supply of goods or services or both where the registered person is not eligible for input tax credit;*
 - (c) *in respect of inter-State supply of goods or services or both made in a financial year to a registered person, where he does not avail of the input tax credit within the specified period and thus remains in the integrated tax account after expiry of the due date for furnishing of annual return for such year in which the supply was made;*
 - (d) *in respect of import of goods or services or both by an unregistered person or by a registered person paying tax under section 10 of the Central Goods and Services Tax Act;*
 - (e) *in respect of import of goods or services or both where the registered person is not eligible for input tax credit;*
 - (f) *in respect of import of goods or services or both made in a financial year by a registered person, where he does not avail of the said credit within the specified period and thus remains in the integrated tax account after expiry of the due date for furnishing of annual return for such year in which the supply was received,*
- the amount of tax calculated at the rate equivalent to the central tax on similar intra-State supply shall be apportioned to the Central Government.*
- (2) *The balance amount of integrated tax remaining in the integrated tax account in respect*

of the supply for which an apportionment to the Central Government has been done under sub-section (1) shall be apportioned to the, —

- (a) State where such supply takes place; and*
- (b) Central Government where such supply takes place in a Union territory:*

Provided that where the place of such supply made by any taxable person cannot be determined separately, the said balance amount shall be apportioned to, —

- (a) each of the States; and*
- (b) Central Government in relation to Union territories,*

in proportion to the total supplies made by such taxable person to each of such States or Union territories, as the case may be, in a financial year:

Provided further that where the taxable person making such supplies is not identifiable, the said balance amount shall be apportioned to all States and the Central Government in proportion to the amount collected as State tax or, as the case may be, Union territory tax, by the respective State or, as the case may be, by the Central Government during the immediately preceding financial year.

- (3) The provisions of sub-sections (1) and (2) relating to apportionment of integrated tax shall, mutatis mutandis, apply to the apportionment of interest, penalty and compounding amount realized in connection with the tax so apportioned.*
- (4) Where an amount has been apportioned to the Central Government or a State Government under sub-section (1) or sub-section (2) or sub-section (3), the amount collected as integrated tax shall stand reduced by an amount equal to the amount so apportioned and the Central Government shall transfer to the central tax account or Union territory tax account, an amount equal to the respective amounts apportioned to the Central Government and shall transfer to the State tax account of the respective States an amount equal to the amount apportioned to that State, in such manner and within such time as may be prescribed.*
- (5) Any integrated tax apportioned to a State or, as the case may be, to the Central Government on account of a Union territory, if subsequently found to be refundable to any person and refunded to such person, shall be reduced from the amount to be apportioned under this section, to such State, or Central Government on account of such Union territory, in such manner and within such time as may be prescribed.*

Statutory Provisions- Effective from 1st February 2019 vide The Central Goods & Services Tax Amendment Act, 2018

17 Apportionment of tax and settlement of funds

- (1) *Out of the integrated tax paid to the Central Government, —*
- (a) *in respect of inter-State supply of goods or services or both to an unregistered person or to a registered person paying tax under section 10 of the Central Goods and Services Tax Act;*
 - (b) *in respect of inter-State supply of goods or services or both where the registered person is not eligible for input tax credit;*
 - (c) *in respect of inter-State supply of goods or services or both made in a financial year to a registered person, where he does not avail of the input tax credit within the specified period and thus remains in the integrated tax account after expiry of the due date for furnishing of annual return for such year in which the supply was made;*
 - (d) *in respect of import of goods or services or both by an unregistered person or by a registered person paying tax under section 10 of the Central Goods and Services Tax Act;*
 - (e) *in respect of import of goods or services or both where the registered person is not eligible for input tax credit;*
 - (f) *in respect of import of goods or services or both made in a financial year by a registered person, where he does not avail of the said credit within the specified period and thus remains in the integrated tax account after expiry of the due date for furnishing of annual return for such year in which the supply was received,*
the amount of tax calculated at the rate equivalent to the central tax on similar intra-State supply shall be apportioned to the Central Government.
- (2) *The balance amount of integrated tax remaining in the integrated tax account in respect of the supply for which an apportionment to the Central Government has been done under sub-section (1) shall be apportioned to the, —*
- (a) *State where such supply takes place; and*
 - (b) *Central Government where such supply takes place in a Union territory:*
Provided that where the place of such supply made by any taxable person cannot be determined separately, the said balance amount shall be apportioned to, —
 - (a) *each of the States; and*
 - (b) *Central Government in relation to Union territories,*
in proportion to the total supplies made by such taxable person to each of such States or Union territories, as the case may be, in a financial year:

Provided further that where the taxable person making such supplies is not identifiable, the said balance amount shall be apportioned to all States and the Central Government in proportion to the amount collected as State tax or, as the case may be, Union territory tax, by the respective State or, as the case may be, by the Central Government during the immediately preceding financial year.

- (2A) *The amount not apportioned under sub-section (1) and sub-section (2) may, for the time being, on the recommendations of the Council be apportioned at the rate of fifty percent to the Central Government and fifty percent to the State Governments or the Union territories as the case may be, on ad hoc basis and shall be adjusted against the amount apportioned under the said sub-sections*
- (3) *The provisions of sub-sections (1) and (2) relating to apportionment of integrated tax shall, mutatis mutandis, apply to the apportionment of interest, penalty and compounding amount realized in connection with the tax so apportioned.*
- (4) *Where an amount has been apportioned to the Central Government or a State Government under sub-section (1) or sub-section (2) or sub-section (3), the amount collected as integrated tax shall stand reduced by an amount equal to the amount so apportioned and the Central Government shall transfer to the central tax account or Union territory tax account, an amount equal to the respective amounts apportioned to the Central Government and shall transfer to the State tax account of the respective States an amount equal to the amount apportioned to that State, in such manner and within such time as may be prescribed.*
- (5) *Any integrated tax apportioned to a State or, as the case may be, to the Central Government on account of a Union territory, if subsequently found to be refundable to any person and refunded to such person, shall be reduced from the amount to be apportioned under this section, to such State, or Central Government on account of such Union territory, in such manner and within such time as may be prescribed.*

Notification No. 3/2017 – Integrated Tax dated 28.06.2017 - Seeks to bring into force certain sections of the IGST Act, 2017 w.e.f 01.07.2017

Notification No. G.S.R. 964(E), F. No. 31013/16/2017-ST-I-DoR, Dated, 27th July, 2017 - Goods and services Tax Settlement of funds Rules, 2017

Notification No. G.S.R. 145(E), F. No. 31013/16/2017-ST-I-DoR Dated, 6th February, 2018 - Goods and services Tax Settlement of funds (Amendment) Rules, 2017

17.1 Introduction

GST is a destination based consumption tax – this principle is evident in the place of supply provisions. Therefore, GST is to be paid to the State where the destination or consumption takes place. And registration of each tax payer in every destination-State is impossible to

comply or administer. It is for this reason that IGST is applicable on supplies whose destination is outside the home-State. Therefore, IGST is not actually a tax but an equitable tax revenue transfer mechanism from the State of origin of supply to the State of its destination where revenue rightly belongs. With IGST having been collected as if it were a tax, it now needs to be transferred to the destination-State. This is provided by section 17 and discussed below.

17.2 Analysis

Inter-State Supply (to)	IGST Paid (on)	Quantum of IGST	Transfer (to)
Unregistered recipient	IGST paid on inter-State supplies IGST paid on import of goods or services	Equivalent Central tax applicable on said supplies in intra-State supply	Union
Composition taxable person			
Registered taxable person not eligible to input tax credit		Balance amount of IGST	State, its respective share of inward supplies@
Registered taxable person eligible to input tax credit but does not avail it within period specified			Union, share of inward supplies to UTs@

@ If this amount cannot be reliably allocated, then rule-of-proportion – total supplies of that State/UT compared to total inter-State supplies during the financial year.

Please note the following further aspects:

- Above formula applies to interest, penalty and compounding amount collected in respect of inter-State supplies
- Any apportioned IGST is found to be refundable, then the same will be recouped from the subsequent transfers
- Time and manner of transfer to States/UTs will be prescribed

Statutory provisions

18. Transfer of input tax credit

- (1) On utilization of credit of integrated tax availed under this Act for payment of, —
- (a) central tax in accordance with the provisions of sub-section (5) of section 49 of the Central Goods and Services Tax Act, the amount collected as integrated tax shall stand reduced by an amount equal to the credit so utilized and the Central Government shall transfer an amount equal to the amount so reduced from the

integrated tax account to the central tax account in such manner and within such time as may be prescribed;

- (b) *Union territory tax in accordance with the provisions of section 9 of the Union Territory Goods and Services Tax Act, the amount collected as integrated tax shall stand reduced by an amount equal to the credit so utilized and the Central Government shall transfer an amount equal to the amount so reduced from the integrated tax account to the Union territory tax account in such manner and within such time as may be prescribed;*
- (c) *State tax in accordance with the provisions of the respective State Goods and Services Tax Act, the amount collected as integrated tax shall stand reduced by an amount equal to the credit so utilized and shall be apportioned to the appropriate State Government and the Central Government shall transfer the amount so apportioned to the account of the appropriate State Government in such manner and within such time as may be prescribed.*

Explanation —For the purposes of this Chapter, “appropriate State” in relation to a taxable person, means the State or Union territory where he is registered or is liable to be registered under the provisions of the Central Goods and Services Tax Act.

Notification No. 3/2017 – Integrated Tax dated 28.06.2017 - Seeks to bring into force certain sections of the IGST Act, 2017 w.e.f 01.07.2017

Notification No. G.S.R. 964(E), F. No. 31013/16/2017-ST-I-DoR, Dated, 27th July, 2017 - Goods and services Tax Settlement of funds Rules, 2017

Notification No. G.S.R. 145(E), F. No. 31013/16/2017-ST-I-DoR Dated, 6th February, 2018 - Goods and services Tax Settlement of funds (Amendment) Rules, 2017

18.1 Introduction

After apportionment of IGST paid, it leaves credit of IGST availed to be accounted for on its utilization. This section addresses the apportionment on utilization of IGST credit.

18.2 Analysis

IGST	Appropriation	Allocation (to)
Credit of IGST paid availed	Utilized to pay CGST	Union – Central tax account
	Utilized to pay SGST	State – State tax account@
	Utilized to pay UTGST	Union – UT tax account@

@ of respective State or UT

Statutory provisions**19. Tax wrongfully collected and paid to Central Government or State Government**

- (1) *A registered person who has paid integrated tax on a supply considered by him to be an inter-State supply, but which is subsequently held to be an intra-State supply, shall be granted refund of the amount of integrated tax so paid in such manner and subject to such conditions as may be prescribed.*
- (2) *A registered person who has paid central tax and State tax or Union territory tax, as the case may be, on a transaction considered by him to be an intra-State supply, but which is subsequently held to be an inter-State supply, shall not be required to pay any interest on the amount of integrated tax payable.*

Relevant circulars, notifications, clarifications, flyers issued by Government

Notification No. 3/2017 – Integrated Tax dated 28.06.2017 - Seeks to bring into force certain sections of the IGST Act, 2017 w.e.f 01.07.2017

19.1 Introduction

Payment of tax based on erroneous determination of 'nature of supply' is not permitted to be adjusted because of the above appropriation of payments. Remedy lies in refund.

19.2 Analysis

Taxable person who has paid tax in error is entitled to refund by first restoring the discharge of the correct tax due so that the incorrect tax paid reflects on the Common Portal as 'paid in excess' and:

- IGST paid in error will be refunded subject to conditions prescribed
- IGST payable due to payment of CGST/SGST/UTGST is exempted from payment of interest on IGST due

Provisions of section 54 of CGST Act have not been extended to this refund although the conditions to be prescribed would not be too far from the requirements in section 54.

Chapter 9

Miscellaneous

20. Application of provisions of Central Goods and Services Tax Act
21. Import of services made on or after the appointed day
22. Power to make rules
23. Power to make regulations
24. Laying of rules, regulations and notifications
25. Removal of difficulties

Statutory Provisions- Effective from 1st July, 2017 to 31st January, 2019

20. Application of provisions of Central Goods and Services Tax Act

Subject to the provisions of this Act and the rules made thereunder, the provisions of Central Goods and Services Tax Act relating to,—

(i) scope of supply; (ii) composite supply and mixed supply; (iii) time and value of supply; (iv) input tax credit; (v) registration; (vi) tax invoice, credit and debit notes; (vii) accounts and records; (viii) returns, other than late fee; (ix) payment of tax; (x) tax deduction at source; (xi) collection of tax at source; (xii) assessment; (xiii) refunds; (xiv) audit; (xv) inspection, search, seizure and arrest; (xvi) demands and recovery; (xvii) liability to pay in certain cases; (xviii) advance ruling; (xix) appeals and revision; (xx) presumption as to documents; (xxi) offences and penalties; (xxii) job work; (xxiii) electronic commerce; (xxiv) transitional provisions; and (xxv) miscellaneous provisions including the provisions relating to the imposition of interest and penalty,

shall, mutatis mutandis, apply, so far as may be, in relation to integrated tax as they apply in relation to central tax as if they are enacted under this Act:

Provided that in the case of tax deducted at source, the deductor shall deduct tax at the rate of two per cent. from the payment made or credited to the supplier:

Provided further that in the case of tax collected at source, the operator shall collect tax at such rate not exceeding two per cent, as may be notified on the recommendations of the Council, of the net value of taxable supplies:

Provided also that for the purposes of this Act, the value of a supply shall include any taxes, duties, cesses, fees and charges levied under any law for the time being in force other than this Act, and the Goods and Services Tax (Compensation to States) Act, if charged separately by the supplier:

Provided also that in cases where the penalty is leviable under the Central Goods and Services Tax Act and the State Goods and Services Tax Act or the Union Territory Goods and Services Tax Act, the penalty leviable under this Act shall be the sum total of the said penalties.

Statutory Provisions- Effective from 1st February 2019 vide The Central Goods & Services Tax Amendment Act, 2018

20. Application of provisions of Central Goods and Services Tax Act

Subject to the provisions of this Act and the rules made thereunder, the provisions of Central Goods and Services Tax Act relating to,—

(i) scope of supply; (ii) composite supply and mixed supply; (iii) time and value of supply; (iv) input tax credit; (v) registration; (vi) tax invoice, credit and debit notes; (vii) accounts and records; (viii) returns, other than late fee; (ix) payment of tax; (x) tax deduction at source; (xi) collection of tax at source; (xii) assessment; (xiii) refunds; (xiv) audit; (xv) inspection, search, seizure and arrest; (xvi) demands and recovery; (xvii) liability to pay in certain cases; (xviii) advance ruling; (xix) appeals and revision; (xx) presumption as to documents; (xxi) offences and penalties; (xxii) job work; (xxiii) electronic commerce; (xxiv) transitional provisions; and (xxv) miscellaneous provisions including the provisions relating to the imposition of interest and penalty,

shall, mutatis mutandis, apply, so far as may be, in relation to integrated tax as they apply in relation to central tax as if they are enacted under this Act:

Provided that in the case of tax deducted at source, the deductor shall deduct tax at the rate of two per cent. from the payment made or credited to the supplier:

Provided further that in the case of tax collected at source, the operator shall collect tax at such rate not exceeding two per cent, as may be notified on the recommendations of the Council, of the net value of taxable supplies:

Provided also that for the purposes of this Act, the value of a supply shall include any taxes, duties, cesses, fees and charges levied under any law for the time being in force other than this Act, and the Goods and Services Tax (Compensation to States) Act, if charged separately by the supplier:

Provided also that in cases where the penalty is leviable under the Central Goods and Services Tax Act and the State Goods and Services Tax Act or the Union Territory Goods and Services Tax Act, the penalty leviable under this Act shall be the sum total of the said penalties.

Provided also that where the appeal is to be filed before Appellate Authority or the Appellate Tribunal, the maximum amount payable shall be fifty crore rupees and one hundred crore rupees respectively.

20.1. Introduction

Certain provisions of CGST Act in relation to levy of tax would be applicable to IGST Act also.

20.2. Analysis

The following provisions of CGST Act shall apply to IGST Act:

- scope of supply;
- composite supply and mixed supply;
- time and value of supply;
- input tax credit;
- registration;
- tax invoice, credit and debit notes;
- accounts and records;
- returns, other than late fee;
- payment of tax;
- tax deduction at source;
- collection of tax at source;
- assessment;
- refunds;
- audit;
- inspection, search, seizure and arrest;
- demands and recovery;
- liability to pay in certain cases;
- advance ruling;
- appeals and revision;
- presumption as to documents;
- offences and penalties;
- job work;
- electronic commerce;
- transitional provisions; and
- miscellaneous provisions including the provisions relating to the imposition of interest and penalty.

The following exceptions are provided:

- (a) In case of TDS (tax deducted at source) the deductor shall deduct tax at the rate of two per cent from the payment made or credited to the supplier.
- (b) In case of TCS (tax collected at source), the operator shall collect tax at such rate not exceeding two per cent, as may be notified on the recommendations of the Council, of the net value of taxable supplies.
- (c) The value of a supply shall include any taxes, duties, cesses, fees and charges levied under any law for the time being in force other than this Act, and the Goods and Services Tax (Compensation to States) Act, if charged separately by the supplier.
- (d) In cases where the penalty is leviable under the CGST Act and the SGST Act or the UTGST Act, the penalty leviable under this Act shall be the sum total of the said penalties.
- (e) The maximum amount of pre-deposit in case of filing of appeal has been prescribed as:
 - i. Rs. 50 crores in case of Appellate Authority
 - ii. Rs. 100 crores in case of Appellate Tribunal

20.3. Comparative Review

Under IGST Act	Corresponding Section under erstwhile Central Sales Tax Act, 1956	Comparison
Section 20 providing CGST Act provisions which would be applicable to IGST Act.	Section 9(2) of CST Act which provides that all provisions of General tax law of each State shall apply in respect of CST to dealers registered in that state, except those provided in CST Act and Rules. These include procedural aspects such as returns, assessment, offences, etc.	Section 9(2) of CST Act does not include aspects such as registration, valuation, credit, etc. which are included in Section 20 of IGST

20.4 FAQs

Q1. What are the provisions under CGST which would be applicable to IGST also?

Ans. The provisions relating to scope of supply, composite supply and mixed supply, time and value of supply, input tax credit, registration, tax invoice, credit and debit notes, accounts and records, returns, other than late fee, payment of tax, tax deduction at source, collection of tax at source, assessment, refunds, audit, inspection, search, seizure and arrest, demands and recovery, liability to pay in certain cases, advance ruling, appeals and revision, presumption as to documents, offences and penalties, job work, electronic commerce, transitional provisions and miscellaneous provisions including the provisions relating to the imposition of interest and penalty, shall apply, in relation to the Integrated Tax as they apply in relation to tax under the CGST Act, 2017.

Q2. What is the percentage of tax to be deducted or collected in case of tax deducted at source and tax collected at source?

Ans. The percentage of tax to be deducted by the deductor from the payment made or credit to the supplier is 2% in case of tax deduction at source.

In case of tax collection at source the operator should collect 2% tax on the value of net supplies.

Statutory provisions

21. Import of services made on or after the appointed day

Import of services made on or after the appointed day shall be liable to tax under the provisions of this Act regardless of whether the transactions for such import of services had been initiated before the appointed day:

Provided that if the tax on such import of services had been paid in full under the existing law, no tax shall be payable on such import under this Act:

Provided further that if the tax on such import of services had been paid in part under the existing law, the balance amount of tax shall be payable on such import under this Act.

Explanation.—For the purposes of this section, a transaction shall be deemed to have been initiated before the appointed day if either the invoice relating to such supply or payment, either in full or in part, has been received or made before the appointed day.

21.1. Introduction

This provision deals with taxability of import of services made after the appointed day.

21.2. Analysis

- (a) It provides that import of services made on or after the appointed day shall be liable to tax under the provisions of IGST Act even if the transactions for such import of services had been initiated before the appointed day.
- (b) However if the tax on such import of services had been paid in full under the pre-GST regime, no tax shall be payable on such import under the IGST Act.
- (c) That apart if the tax on such import of services had been paid in part under the erstwhile law, the balance amount of tax shall be payable on such import under this Act.
- (d) As per the explanation appended to the section a transaction shall be deemed to have been initiated before the appointed day if either the invoice or payment, either in full or in part, has been received or made before the appointed day.

21.3. FAQs

Q1. Whether import of services made after appointed day is liable to tax under this Act?

Ans.. Yes. Any import of services made after appointed day is liable to tax under this Act. However, the taxability is subject to the provisos in section 21 of IGST Act.

Q2. What would be the status of import of services, where the tax on the said transaction is paid in full under earlier laws?

Ans. Not liable to tax under this Act. As per the first proviso of section 21 of IGST Act, where the tax on import of services is paid in full under earlier laws, no tax under this Act would be made applicable though such import takes place after the appointed day.

Q3. What would be the status of import of services where the tax on the said transaction is paid in part under earlier laws?

Ans. As per the second proviso to section 21 of IGST Act, where the tax is paid in part for import of services under the earlier laws, only the balance amount of tax would be payable under this Act.

Q4. When would the transaction be deemed to have been initiated before the appointed day?

Ans. Under any of the following circumstances it would be deemed that the transaction is initiated before the appointed day-

(i) Where invoice relating to such supply; or

(ii) Payment, either in full or in part;

has been received or made before the appointed day.

21.4 MCQs

Q1. Where the tax is fully paid under earlier laws, amount of tax payable for import of services made after appointed day is?

(a) No tax payable under this Act

(b) Tax as per this Act, to be paid again

Ans. (a) No tax payable under this Act

Q2. Where the tax is paid in part under earlier laws, amount of tax payable for import of services made after appointed day is?

(a) No tax payable under this Act

(b) Balance amount of tax payable on such import of services

Ans. (b) Balance amount of tax payable on such import of services

Statutory provisions

22. **Power to make rules**

(1) *The Government may, on the recommendations of the Council, by notification, make rules for carrying out the provisions of this Act.*

(2) *Without prejudice to the generality of the provisions of sub-section (1), the Government*

may make rules for all or any of the matters which by this Act are required to be, or may be, prescribed or in respect of which provisions are to be or may be made by rules.

- (3) *The power to make rules conferred by this section shall include the power to give retrospective effect to the rules or any of them from a date not earlier than the date on which the provisions of this Act come into force.*
- (4) *Any rules made under sub-section (1) may provide that a contravention thereof shall be liable to a penalty not exceeding ten thousand rupees.*

22.1. Introduction

- (i) It provides power to the Central Government to make Rules for the purposes of IGST Act upon recommendations by the GST Council.

22.2 Analysis

- (i) Power to make rules by the Central Government is discussed hereunder:
- The Central Government may make rules for carrying out the purposes of this Act, by notification on the recommendations of the Council.
 - The Government may make rules for all or any of the matters which by this Act are required to be, or may be, prescribed or in respect of which provisions are to be or may be made by rules.
 - The power to make rules shall include the power to give retrospective effect to the rules or any of them from a date not earlier than the appointed day.
 - Any rules made may provide for penalty upto Rs.10,000 for contravention thereof.
 - “Council” would mean the Goods and Services Tax Council established under Article 279A of the Constitution.

22.3 Comparative review

Under IGST Act	Corresponding Section under erstwhile Central Sales Tax Act, 1956
Section 22 of IGST Act which deals with powers of Central Government to make rules	Section 13 authorizes Central Government to make rules. However, specific scenarios for making rules have been specified like manner of application for registration, form of declaration or certificate.

22.4 FAQs

Q1. Who is given the power to make rules under IGST Act?

Ans. The Central Government may, by notification, make rules for carrying out the purposes of this Act on the recommendation of the Council.

22.5 MCQs

Q1. Under section 22, the Central Government has power to make rules on recommendation of whom of the following?

- (a) Ministry of Finance
- (b) GST Council
- (c) CBEC
- (d) None of the above

Ans. (b) GST Council

Statutory provisions**23. Power to make regulations**

The Board may, by notification, make regulations consistent with this Act and the rules made thereunder to carry out the provisions of this Act.

23.1. Introduction

This provision refers to the Board's power to make regulations.

23.2. Analysis

To carry out the provisions of the IGST Act, the Board is empowered to make regulations, which would be notified. Such regulations should not be inconsistent with the provisions of the IGST Act and the Rules made thereunder.

Statutory provisions**24. Laying of rules, regulations and notifications**

Every rule made by the Government, every regulation made by the Board and every notification issued by the Government under this Act, shall be laid, as soon as may be, after it is made or issued, before each House of Parliament, while it is in session, for a total period of thirty days which may be comprised in one session or in two or more successive sessions, and if, before the expiry of the session immediately following the session or the successive sessions aforesaid, both Houses agree in making any modification in the rule or regulation or in the notification, as the case may be, or both Houses agree that the rule or regulation or the notification should not be made, the rule or regulation or notification, as the case may be, shall thereafter have effect only in such modified form or be of no effect, as the case may be; so, however, that any such modification or annulment shall be without prejudice to the validity of anything previously done under that rule or regulation or notification, as the case may be.

24.1. Introduction

This section lays down the general procedure of laying delegated legislations before the Parliament for a prescribed duration.

Analysis

- (a) The Act permits making of rules by Government, issuance of regulation by Board and issuance of notification by the Government.
- (b) Such rule, regulation and notification, which is a part of delegated legislation is placed before the Parliament.
- (c) It is laid before the Parliament, as soon as may be after it is made or issued, when the Parliament is in session, for a total period of thirty days which may be comprised in one session or in two or more successive sessions
- (d) Before the expiry of the session or successive sessions both Houses may make suitable modifications and would have effect in such modified form.
- (e) However, any such modification or annulment shall be without prejudice to the validity of anything previously done under that rule or regulation or notification, as the case may be.

24.3. Comparative Review

Similar provisions were there in the erstwhile tax laws as well.

Statutory provisions**25 Removal of Difficulties**

- (1) *If any difficulty arises in giving effect to any provision of this Act, the Government may, on the recommendations of the Council, by a general or a special order published in the Official Gazette, make such provisions not inconsistent with the provisions of this Act or the rules or regulations made thereunder, as may be necessary or expedient for the purpose of removing the said difficulty:*

Provided that no such order shall be made after the expiry of a period of three years from the date of commencement of this Act.

- (2) *Every order made under this section shall be laid, as soon as may be, after it is made, before each House of Parliament.*

25.1. Introduction

The responsibility to implement the legislatures' will is of the appropriate Government. In doing this, the Act empowers the appropriate Government with the necessary power to remove any difficulty that may arise.

25.2. Analysis

- (i) If the Government identifies that there is a difficulty in implementation of any provision of the GST Legislation, it has powers to issue a general or special order, to carry out anything to remove such difficulty.

- (ii) Such activity of the Government must be consistent with the provisions of the Act and should be necessary or expedient.
- (iii) Maximum time limit for passing such order shall be 3 years from the date of effect of the IGST Act.

25.3. Comparative review

The above provisions were present in all the tax legislations, to ensure that any practical difficulties in implementation can be addressed.

25.4. Related provisions of the Statute:

This is an independent section and would be applicable for implementation of the GST law.

25.5. FAQs

Q1. Will the powers include the power to notify the effective date for implementation of particular provisions?

Ans. Yes, all powers regarding implementation of any provision of the GST law is covered.

Q2. Will the powers include bringing changes in any provision of law?

Ans. No, the Government has power only to decide on the practical implementation of law. But it cannot amend the Legislation through this section.

Q3. What is the maximum time limit for exercising the powers under Section 25?

Ans. The maximum time limit is 3 years from the date of effect of IGST Act.

Q4. Whether the reasons be mentioned in the order?

Ans. The order is issued only when there is a necessity or expediency for it. Specific reasons may not be mentioned in the order.

25.6. MCQs

Q1. Whether prior approval of the Parliament is necessary?

(a) Yes

(b) No

Ans. (b) No

Q2. What is the maximum period for exercising this power?

(a) 4 years

(b) 3 years

(c) 2 years

(d) 1 year

Ans. (b) 3 years

THE UNION TERRITORY GOODS AND SERVICES TAX ACT, 2017

Statement of Objects and Reasons

The Union Territories (for brevity, "UT") were earlier empowered to levy Sales Tax / VAT on the sale of goods, whereas the Central Government was empowered to levy excise duty and service tax on manufacture of goods and supply of services, respectively. This led to a multiplicity of indirect taxes being levied by various authorities.

The difficulties faced in the erstwhile indirect tax system were:

- (i) Rising hidden costs in trade and industry due to multiplicity of taxes at the Central and Union Territory levels
- (ii) Lack of uniformity of tax rates and tax structure, compliance procedures across Union Territories
- (iii) Cascading of taxes
- (iv) Non-availability of cross-utilization of credits i.e., utilization of excise duty and service tax credits against taxes levied by Union Territories and vice-versa.
- (v) Credit of taxes levied by one Union Territory or State cannot be set off against taxes levied by other Union Territories or States.

Under the GST regime, Union Territory tax along with related GST legislations replaced the erstwhile taxes while empowering the Central Government to levy Union Territory tax on the supply of goods or services or both taking place within a Union Territory not having a Legislature. The GST legislation:

- (i) Provides for levy of tax on all intra-State supplies of goods or services or both, except alcoholic liquor for human consumption, at the rates recommended by the GST Council;
- (ii) Empowers the Central Government to grant exemptions on the recommendation of the GST Council;
- (iii) Enables apportionment of tax and settlement of funds on account of transfer of input tax credit between the Central Government, State Governments and Union Territories;
- (iv) Empowers recovery of tax, interest or penalty payable by a person and remaining unpaid;
- (v) Empowers establishing of an Authority for Advance Ruling to enable the taxpayers to seek binding clarity on taxation matters;
- (vi) Provides for elaborate transitional provisions for smooth transition of taxpayers to GST regime; and
- (vii) Allows application of certain provisions of the CGST Act, 2017 to the extent relevant for the purposes of this Act;

Chapter 1

Preliminary

1. Short title, extent and commencement
2. Definitions

Statutory provision – Effective from 1st July 2018 to 31st January 2019

1. Short title, extent and commencement

- (1) *This Act may be called the Union Territory Goods and Service Tax Act, 2017.*
- (2) *It extends to the Union territories of Andaman and Nicobar Islands, Lakshadweep, Dadra and Nagar Haveli, Daman and Diu, Chandigarh and other territory.*
- (3) *It shall come into force on such date as the Central may, by notification in the Official Gazette, appoint:*

Provided that different dates may be appointed for different provisions of this Act and any reference in any such provision to the commencement of this Act shall be construed as a reference to the coming into force of that provision.

Title:

All Acts enacted by the Parliament since the introduction of the Indian Short Titles Act, 1897 carry a long and a short title. The *long title*, set out at the head of a statute, gives a fair description of the general purpose of the Act and broadly covers the scope of the Act.

The *short title*, serves simply as an ease of reference and is considered a statutory nickname to obviate the necessity of referring to the Act under its full and descriptive title. Its object is identification, and not description, of the purpose of the Act.

Extent:

Part I of the Constitution of India states: "India, that is Bharat, shall be a Union of States". It provides that territory of India shall comprise the States and the Union Territories specified in the First Schedule of the Constitution of India. The First Schedule provides for twenty-nine (29) States and seven (2 with legislation + 5 without legislation =7) Union Territories.

Part VI of the Constitution of India provides that for every State, there shall be a Legislature, while Part VIII provides that every Union Territory shall be administered by the President through an 'Administrator' appointed by him. However, the Union Territories of Delhi and Puducherry have been provided with Legislatures with powers and functions as required for their administration.

India is a summation of three categories of territories namely – (i) States (29); (ii) Union Territories with Legislature (2); and (iii) Union Territories without Legislature (5).

'State' under the GST law is defined to include a Union Territory with Legislature. Delhi and Puducherry, though are Union Territories, have a Legislature of their own. Accordingly, for the purpose of GST Laws, the Union Territories of Delhi and Puducherry will be regarded as a State and will be governed by the respective SGST laws passed by them, instead of the UTGST law which is passed by the Central Government.

Commencement:

The UTGST Act came into operation on the date appointed by the Central Government by means of a notification in the Official Gazette (i.e. 1st July 2017). A provision has been made to notify different dates for commencement of different provisions of the Act.

It is expected that a notification with a prospective date of commencement of the UTGST Act i.e., a specific date succeeding the date of notification in the Official Gazette, would be issued. A notification providing for a retrospective date for commencement of the UTGST Act cannot be issued, since that would result in simultaneous operation of two laws governing the same subject matter i.e., the erstwhile law(s) and the UTGST Act being in force during the period starting from such retrospective date of commencement until the date of notification in the Official Gazette.

Statutory provisions**2. Definitions**

In this Act, unless the context otherwise requires—

(1) "*appointed day*" means the date on which the provisions of this Act shall come into force.

The provisions of the UTGST Act are implemented with effect from 1st July 2017 with powers vested to notify different dates for effective date of commencement of different provisions of the Act.

(2) "*Commissioner*" means the Commissioner of Union territory tax appointed under section 3;

Every Union Territory is administered by the President through an Administrator appointed by him. The Administrator, in turn, is empowered to appoint Commissioners and other officers for carrying out the purposes of the Act who will be deemed to be 'Proper Officers' for administering the Act.

The officers appointed under the erstwhile central and UT laws will continue to function as officers under the UTGST Act as well.

(3) "*designated authority*" means such authority as may be notified by the Commissioner;

Currently, the term does not find a reference in the Act and will be notified by the Commissioner from time to time.

(4) “exempt supply” means supply of any goods or services or both which attracts nil rate of tax or which may be exempt from tax under section 8, or under section 6 of the Integrated Goods and Services Tax Act, and includes non-taxable supply;

The meaning of exempt supply is similar to the meaning assigned to it under the CGST law with the exception that supplies that are **partly exempted** from tax under this Act will also be considered as ‘exempt supply’. On the contrary, partially exempted supplies under the CGST law would not be considered as ‘exempt supplies’ under the CGST law. The word “wholly” found in section 2(47) of the CGST law which is missing from section 2(4) under the UTGST law in the definition of exempt supply.

Exempt supplies comprise the following 3 types of supplies:

- (a) supplies taxable at a ‘NIL’ rate of tax;
- (b) supplies that are wholly or partially exempted from UTGST or IGST, by way of a notification; and
- (c) supplies that are not taxable under the Act (petrol, high speed diesel, alcoholic liquor for human consumption etc.)

The following aspects need to be noted:

- (a) Zero-rated supplies such as exports would not be treated as supplies taxable at ‘NIL’ rate of tax;
- (b) Input tax credit attributable to exempt supplies will not be available for utilisation/ set-off.

(5) “existing law” means any law, notification, order, rule or regulation relating to levy and collection of duty or tax on goods or services or both passed or made before the commencement of this Act by Parliament or any Authority or person having the power to make such law, notification, order, rule or regulation;

This covers all the erstwhile Central and State laws (along with the relevant notifications, orders, and regulations), relating to levy of tax on goods or services like Service Tax law, Central Excise law, State VAT laws, etc. Therefore, laws that do not levy tax or duty on goods or services, such as The Indian Stamp Act, 1899, would not be covered here.

(6) “Government” means the Administrator or any authority or officer authorized to act as Administrator by the Central Government;

Every Union Territory is administered by the President through an ‘Administrator’ appointed by him. Even a Governor of a State can be appointed as the Administrator of an adjoining UT. Such an Administrator will be regarded as ‘Government’ for the purposes of the UTGST law.

(7) “output tax” in relation to a taxable person, means the Union territory tax chargeable under this Act on taxable supply of goods or services or both made by him or by his agent but excludes tax payable by him on reverse charge basis;

The output tax chargeable on taxable supply of goods or services can be summarised as under:

Type of Supply	Output tax	Reference
Supplies within a UT without Legislature	UTGST + CGST (intra-State supply)	Section 8(1) and 8(2) of the IGST Act
Supplies between two UT without Legislature	IGST (inter-State supply)	Section 7(1) and 7(3) of the IGST Act
Supplies between a UT without Legislature and a State (including UT with Legislature)	IGST (inter-State supply)	Section 7(1) and 7(3) of the IGST Act

The following aspects need to be noted:

- (a) While input tax is in relation to a registered person, output tax is in relation to a taxable person. Evidently, the law excludes persons who are not registered under the Statute from being associated with any input tax. However, where there is a liability due to the Government, the law paves the way to cover those persons who are liable to tax, but who have failed to obtain registration.
- (b) The amount covered under this term is the tax 'chargeable' under law, and not what is 'charged'. Therefore, some experts believe that in case a person wrongly charges an amount as tax, or charges an excess rate of tax as compared to the applicable tax rate, such excess would not qualify as output tax.
- (c) Some experts are of the view that taxes payable on reverse charge basis would also be out of the scope of 'output tax'. Since credit of input tax can only be used to pay output tax, the above will have to be discharged by way of cash only (i.e., through the electronic cash ledger, on depositing money by means of cash, cheque, etc.).
- (d) The law makes a specific inclusion in respect of supplies made by an agent on behalf of the supplier, to treat the UT tax payable on such supplies as output tax in the hands of the supplier.

(8) "Union territory" means the territory of, —

- (i) the Andaman and Nicobar Islands;
- (ii) Lakshadweep;
- (iii) Dadra and Nagar Haveli;
- (iv) Daman and Diu;
- (v) Chandigarh; or
- (vi) other territory.

Explanation. —For the purposes of this Act, each of the territories specified in sub-clauses (i) to (vi) shall be a separate Union territory;

Analysis

'State' under the GST law is defined under the CGST Act to include a Union Territory with Legislature. Delhi and Puducherry, being UTs with Legislature, will be regarded as 'States' for GST, and will be governed by their respective SGST laws, instead of the UTGST law.

By definition, the expression 'other territory' is inclusive of all territories that do not form part of any State (including the UTs of Delhi and Puducherry), and excludes the five UTs without Legislature listed under clauses (i) to (v) of the definition.

All territories that fall into the ambit of 'other territory' would also form part of the meaning of the term 'Union territory'. The purpose of this inclusion is to ensure that any Indian territory that remains unclaimed by all the States and Union Territories can be brought into the scope of GST. Although there is no specific indication that the extent of the term should be limited to the territory of India, locations outside India cannot be said to fall into the scope of 'other territory' defined above, as it would defeat the purpose of law.

(9) "Union territory tax" means the tax levied under this Act;

It refers to the tax charged under this Act on intra-State supply of goods or services or both, in addition to the tax levied under the CGST law. The rate of UT tax is capped at 20% and will be notified by the Central Government based on the recommendation of the GST Council.

(10) words and expressions used and not defined in this Act but defined in the Central Goods and Services Tax Act, the Integrated Goods and Services Tax Act, the State Goods and Services Tax Act, and the Goods and Services Tax (Compensation to States) Act, shall have the same meaning as assigned to them in those Acts.

Certain words and expressions like person, supplier, recipient, intra-state supply, reverse charge, cess, place of supply etc. defined in the CGST/ SGST/ IGST laws will have the same meaning for UTGST law.

Chapter 2

Administration

3. **Officers under this Act**
4. **Authorisation of officers**
5. **Powers of officers**
6. **Authorisation of officers of Central Tax as proper officer in certain circumstances**

Statutory provision

3. Officers under this Act

The Administrator may, by notification, appoint Commissioners and such other class of officers as may be required for carrying out the purposes of this Act and such officers shall be deemed to be proper officers for such purposes as may be specified therein:

Provided that the officers appointed under the existing law shall be deemed to be the officers appointed under the provisions of this Act.

4. Authorisation of officers

The Administrator may, by order, authorise any officer to appoint officers of Union territory tax below the rank of Assistant Commissioner of Union territory tax for the administration of this Act.

5. Powers of officers

- (1) *Subject to such conditions and limitations as the Commissioner may impose, an officer of the Union territory tax may exercise the powers and discharge the duties conferred or imposed on him under this Act.*
- (2) *An officer of a Union territory tax may exercise the powers and discharge the duties conferred or imposed under this Act on any other officer of a Union territory tax who is subordinate to him.*
- (3) *The Commissioner may, subject to such conditions and limitations as may be specified in this behalf by him, delegate his powers to any other officer subordinate to him.*
- (4) *Notwithstanding anything contained in this section, an Appellate Authority shall not exercise the powers and discharge the duties conferred or imposed on any other officer of Union territory tax.*

6. Authorisation of officers of Central Tax as proper officer in certain circumstances

- (1) *Without prejudice to the provisions of this Act, the officers appointed under the Central*

Goods and Services Tax Act are authorised to be the proper officers for the purposes of this Act, subject to such conditions as the Government shall, on the recommendations of the Council, by notification, specify.

- (2) *Subject to the conditions specified in the notification issued under sub-section (1), —*
- (a) *where any proper officer issues an order under this Act, he shall also issue an order under the Central Goods and Services Tax Act, as authorised by the said Act under intimation to the jurisdictional officer of central tax;*
 - (b) *where a proper officer under the Central Goods and Services Tax Act has initiated any proceedings on a subject matter, no proceedings shall be initiated by the proper officer under this Act on the same subject matter.*
- (3) *Any proceedings for rectification, appeal and revision, wherever applicable, of any order passed by an officer appointed under this Act, shall not lie before an officer appointed under the Central Goods and Services Tax Act.*

Introduction

Union Territory without a legislature enjoys laws passed by Parliament. The UTGST Act is one where the law is by the Parliament but its administration is left with the Administrator of the Union Territory.

Analysis

Without being bound by the rigours and specificity of executive officers under the CGST act, the UTGST Act empowers the Administrator to issue a notification appointing one or more Commissioners and such other class of officers as required.

The Administrator is also empowered to appoint officers lower in rank than the Assistant Commissioner as required. Commissioners appointed by the Administrator are empowered to impose conditions and limitations necessary in the discharge of functions by the officers of UT Tax. A superior officer is permitted to discharge the functions and exercise the authority conferred on a subordinate officer. Interestingly, we do not find such flexibility in CGST Act and IGST Act. Not only does this Act prescribed the Assuming of power by a superior officer but also permits delegation of vested powers to be exercised by any other officer of UT Tax. Appellate authorities under this act are denied the flexibility of such appropriation or delegation of power vested in them.

Continuing with efficiency in tax administration, without causing any prejudice to the UT Tax Act, officers under the CGST Act are authorised to be officers under this Act. This is permitted only upon the recommendation of the Council and subject to any conditions that may be imposed by the Administrator.

Where officers under this Act initiate any proceedings, said officers shall proceed to pass orders not only in respect of UT Tax but also in respect of Central Tax. Where such conjoined

proceedings are underway, the said officers are expected to intimate officers of Central Tax. Similarly, where proceedings initiated by officers in respect of Central tax, the underlying transaction or the taxable base being the same, such officers under the CGST Act, are required to pass orders addressing demands in respect of UT Tax arising from the common underlying transactions. Whichever officer initiates any proceedings will determine the law and forum for exercising lawful jurisdiction in respect of rectification, appeal and revision.

Chapter 3

Levy and Collection of Tax

7. Levy and Collection

8. Power to grant exemption from tax

Statutory provisions – Effective from 1st July 2017 to 31st January 2019

7. Levy and collection

- (1) *Subject to the provisions of sub-section (2), there shall be levied a tax called the Union territory tax on all intra-State supplies of goods or services or both, except on the supply of alcoholic liquor for human consumption, on the value determined under section 15 of the Central Goods and Services Tax Act and at such rates, not exceeding twenty per cent., as may be notified by the Central Government on the recommendations of the Council and collected in such manner as may be prescribed and shall be paid by the taxable person.*
- (2) *The Union territory tax on the supply of petroleum crude, high speed diesel, motor spirit (commonly known as petrol), natural gas and aviation turbine fuel shall be levied with effect from such date as may be notified by the Central Government on the recommendations of the Council.*
- (3) *The Central Government may, on the recommendations of the Council, by notification, specify categories of supply of goods or services or both, the tax on which shall be paid on reverse charge basis by the recipient of such goods or services or both and all the provisions of this Act shall apply to such recipient as if he is the person liable for paying the tax in relation to the supply of such goods or services or both.*
- (4) *The Union territory tax in respect of the supply of taxable goods or services or both by a supplier, who is not registered, to a registered person shall be paid by such person on reverse charge basis as the recipient and all the provisions of this Act shall apply to such recipient as if he is the person liable for paying the tax in relation to the supply of such goods or services or both.*
- (5) *The Central Government may, on the recommendations of the Council, by notification, specify categories of services the tax on intra-State supplies of which shall be paid by the electronic commerce operator if such services are supplied through it, and all the provisions of this Act shall apply to such electronic commerce operator as if he is the supplier liable for paying the tax in relation to the supply of such services.*

Provided that where an electronic commerce operator does not have a physical presence in the taxable territory, any person representing such electronic commerce operator for any purpose in the taxable territory shall be liable to pay tax.

Provided further that where an electronic commerce operator does not have a physical presence in the taxable territory and, he does not have a representative in the said territory, such electronic commerce operator shall appoint a person in the taxable territory for paying tax and such person shall be liable to pay tax.

Statutory provisions - Effective from 1st February, 2019 vide The Union Territory Goods and Services Tax Amendment Act, 2018

7. Levy and collection

- (1) *Subject to the provisions of sub-section (2), there shall be levied a tax called the Union territory tax on all intra-State supplies of goods or services or both, except on the supply of alcoholic liquor for human consumption, on the value determined under section 15 of the Central Goods and Services Tax Act and at such rates, not exceeding twenty per cent., as may be notified by the Central Government on the recommendations of the Council and collected in such manner as may be prescribed and shall be paid by the taxable person.*
- (2) *The Union territory tax on the supply of petroleum crude, high speed diesel, motor spirit (commonly known as petrol), natural gas and aviation turbine fuel shall be levied with effect from such date as may be notified by the Central Government on the recommendations of the Council.*
- (3) *The Central Government may, on the recommendations of the Council, by notification, specify categories of supply of goods or services or both, the tax on which shall be paid on reverse charge basis by the recipient of such goods or services or both and all the provisions of this Act shall apply to such recipient as if he is the person liable for paying the tax in relation to the supply of such goods or services or both.*
- (4) *The Government may, on the recommendations of the Council, by notification, specify a class of registered persons who shall, in respect of supply of specified categories of goods or services or both received from an unregistered supplier, pay the tax on reverse charge basis as the recipient of such supply of goods or services or both, and all the provisions of this Act shall apply to such recipient as if he is the person liable for paying the tax in relation to such supply of goods or services or both..*
- (5) *The Central Government may, on the recommendations of the Council, by notification, specify categories of services the tax on intra-State supplies of which shall be paid by the electronic commerce operator if such services are supplied through it, and all the provisions of this Act shall apply to such electronic commerce operator as if he is the supplier liable for paying the tax in relation to the supply of such services.*

Provided that where an electronic commerce operator does not have a physical presence in the taxable territory, any person representing such electronic commerce operator for any purpose in the taxable territory shall be liable to pay tax.

Provided further that where an electronic commerce operator does not have a physical presence in the taxable territory and, he does not have a representative in the said territory, such electronic commerce operator shall appoint a person in the taxable territory for paying tax and such person shall be liable to pay tax.

7.1. Introduction

- a) The Constitution mandates that no tax shall be levied or collected by a taxing Statute except by authority of law. While no one can be taxed by implication, a person can be subject to tax in terms of the charging section only.
- b) Section 7 is the charging provision of the UTGST Act. It provides that all intra-State supplies would be liable to UTGST subject to a ceiling rate of 20%. The levy is on all goods or services or both except on the supply of alcoholic liquor for human consumption. Besides, GST may be levied on the supply of petroleum crude, high speed diesel, motor spirit (petrol), natural gas and aviation turbine fuel with effect from such date as may be notified by the Government after recommendation of the Council. It also provides for the value on which tax shall be paid, the maximum rate of tax applicable on such supplies, the manner of collection of tax by the Government and the person who will be liable to pay such tax. The provision of this section is comparable to the provisions of section 9 of the CGST Act.
- c) Under the UTGST law, the levy of tax is as follows:
 - (a) In the hands of the supplier - on the supply of goods and / or services (referred to as tax under forward charge mechanism);
 - (b) In the hands of the recipient – on receipt of goods and / or services (referred to as tax under reverse charge mechanism)
 - (c) In the hands of electronic commerce operator-on services supplied by the suppliers through such electronic commerce operator

In the normal course, the tax would be payable by the supplier of goods and/or services. However, in specific cases (as may be notified), the onus of payment of tax is shifted to the recipient of goods and/or services.

Normally, the supplier of goods or services or both will be liable to discharge tax on the supplies effected. However, the Central Government is empowered to specify categories of supplies in respect of which the recipient of goods or services or both will be liable to discharge the tax.

Accordingly, all other provisions of this Act and CGST Act, as applicable, will apply to the recipient of such goods or services or both, as if the recipient is the supplier of such goods or services or both – viz., for the limited purpose of such transactions, the recipient would be deemed to be the 'supplier'.

- d) When specified category of goods/ services are supplied by a supplier, who is un-registered person to a receiver, who falls under specified class of registered person, the liability to pay tax on such supplies will be on recipient under reverse charge basis. Thus, specified class of registered person would be required to pay GST on all supplies received by it from un-registered persons. Reverse charge mechanism is not applicable on recipient of goods/services, who are registered but do not fall under specified class of registered person, receiving such goods/services from un-registered person. However, the government has not yet notified any specific class of registered person and specific category of goods or services supplied by un-registered person to it, on which Reverse charge mechanism would be applicable.
- e) Additionally, where any supply of services is effected through e-commerce operators, the law provides that the Central Government may on recommendation of the Council notify that the e-commerce operator will be liable to discharge the tax on such supplies where the e-commerce operator:
- (a) Does not have a physical presence then the person who represents the e-commerce operator will be liable to pay tax.
 - (b) Does not have a physical presence or a representative, then the e-commerce operator is mandatorily required to appoint a person who will be liable to pay tax.
- f) In so far as e-commerce operators are concerned, care must be exercised to determine the nature of business of such operators. Essentially, there are four models of e-commerce business:
- (a) Market-place – the question of supply by the e-commerce operator does not arise. For this reason, they are liable for TCS under section 52.
 - (b) Fulfilment centre – here States have been contesting that this model is one involving 'buy-sell' and accordingly liable to VAT. The test here is to establish the fact that the supply is by supplier directly to the end customer and not 'through' the e-commerce operator.
 - (c) Hybrid (of above 2) – all though not widely prevalent, this is a case where both buy-sell as well as market-place models are employed. It is important for such business to clearly establish which side of the fence they are would prefer to fall on so that the respective incidence of tax follows.
 - (d) Agency – this is employed by few businesses involving supply of industrial inputs. The *modus operandi* is that the principal logs in to the portal and routes the supplies to the end customer. The agreements are so framed that the e-commerce operator becomes responsible for the delivery and collection of payment. This renders the e-commerce Operator to constitute an agency. Such arrangements need to be vetted to ensure the inference of agency that emerges if it is not so desired, then the same may be redrafted suitably. Schedule I of the CGST Act states that transactions between principal and agent are deemed to be

a supply and liable to tax. This consequence may be borne in mind even by e-commerce businesses.

7.2 Analysis

The discussion of Levy under Section 9 of the CGST Act made in this book may be referred for detailed analysis

Levy of tax: Every intra-State supply will be liable to tax, if:

- (a) Supply should involve goods or services or both viz., wholly goods or wholly services or both viz.,

Even where a supply involves both, goods and services, the law provides that such supplies would be classifiable either as, wholly goods or wholly services. The reference to be made to Schedule II of the CGST Act which provides for this classification.

- (b) The supply is an intra-State supply – viz., ordinarily, the location of the supplier and the place of supply is in same Union Territory. (Refer Section 8 of the IGST Act to understand the meaning of intra-State supply);
- (c) The tax shall be payable by a 'taxable person' as explained in definition Sec. 2(107) and explained in Section 22 & 24 of CGST Act.

Tax shall be payable by a 'taxable person': The tax shall be payable by a 'taxable person' i.e. person/ separate establishments of persons registered or liable to be registered under section 22 and 24 of the CGST Act..

Rate and value of tax: The rate of tax will be as specified in the notification that would be issued in this regard, subject to a maximum of 20%. The rates would be determined based on the recommendation of the Council and the rate of tax so notified will apply on the value of supplies as determined under Section 15 of the CGST Act.

Supply:

Refer discussion under Chapter III of the CGST Act for a detailed understanding of the expression 'supply'. Additionally, the comments relating to 'composite supply' and 'mixed supply' and 'reverse charge' will equally apply for supplies taxable under UTGST Act.

7.3 Comparative review

Under the erstwhile tax laws, Central Excise is on 'manufacture of goods', VAT/CST is on 'sale of goods' and Service tax is on 'provision of service'. Unlike different incidences, under the GST law, it is 'supply' which would be the taxable event. Under the earlier law, e.g.: while stock transfers are liable to Central Excise (if they are removed from the factory), it would not be liable to VAT / CST. However, under the GST law, it would be taxable as a 'supply'. Further, free supplies would be liable to excise duty, while under the GST laws, free supplies would require reversal of input tax credit;

Under the erstwhile law, there are multiple transactions which apparently qualify as both 'sale of goods' as well as 'provision of services'. e.g. license of software, providing a right to use a brand name, etc. Unlike this situation, GST clarifies as to whether a transaction would qualify as a 'supply of goods' or as 'supply of services'. A transaction would either qualify as goods or as services, under the GST law. Even in respect of composite contracts, it has been clarified under Schedule II, Definition of composite supply and mixed supply in the CGST law.

The payment of VAT in the hands of the purchaser (registered dealer) on purchase of goods from an unregistered dealer and the circumstances where the Service Tax is payable under the reverse charge mechanism in respect of say, import of services, sponsorship services etc. are comparable to the 'reverse charge mechanism' prescribed herein. Further, the concept of reverse charge only exists in relation to services. The GST law, however, permits the supply of goods also to be subjected to reverse charge.

7.4 Related provisions

Statute	Section	Description
CGST	Section 7 read with Schedule I, II and III	Definition of 'supply'
CGST	Section 2(17)	Definition of 'business'
CGST	Section 2(107) read with 22 and 24	Meaning of 'taxable person' and distinct persons
CGST	Section 2(31)	Meaning of consideration
IGST	Section 8	Meaning of intra-State supplies
UTGST	Section 7	Levy and collection of UTGST

7.5 FAQs

- Q1. Is the reverse charge mechanism applicable only to services?
 Ans. No. Reverse charge applies to supplies of goods or services or both.
- Q2. What will be the implications in case of purchase of goods from unregistered dealers?
 Ans. The receiver of goods would be liable to pay tax under reverse charge.

7.6 MCQs

- Q1. As per Section 7, which of the following would attract levy of UTGST?
- Inter-state supplies
 - Intra-state supplies
 - Any of the above
 - None of the above

Ans. (b) Intra-state supplies

Q2. Who can notify a supply to be taxed under reverse charge basis?

- (a) Board
- (b) Central Government
- (c) GST Council
- (d) None of the above

Ans. (b) Central Government.

Statutory provisions

8. Power to grant exemption from tax

- (1) *Where the Central Government is satisfied that it is necessary in the public interest so to do, it may, on the recommendations of the Council, by notification, exempt generally either absolutely or subject to such conditions as may be specified therein, goods or services or both of any specified description from the whole or any part of the tax leviable thereon with effect from such date as may be specified in such notification.*
- (2) *Where the Central Government is satisfied that it is necessary in the public interest so to do, it may, on the recommendations of the Council, by special order in each case, under circumstances of an exceptional nature to be stated in such order, exempt from payment of tax any goods or services or both on which tax is leviable.*
- (3) *The Central Government may, if it considers necessary or expedient so to do for the purpose of clarifying the scope or applicability of any notification issued under sub-section (1) or order issued under sub-section (2), insert an explanation in such notification or order, as the case may be, by notification at any time within one year of issue of the notification under sub-section (1) or order under sub-section (2), and every such explanation shall have effect as if it had always been the part of the first such notification or order, as the case may be.*
- (4) *Any notification issued by the Central Government under sub-section (1) of section 11 or order issued under sub-section (2) of the said section of the Central Goods and Services Tax Act shall be deemed to be a notification or an order issued under this Act.*

Explanation. —For the purposes of this section, where an exemption in respect of any goods or services or both from the whole or part of the tax leviable thereon has been granted absolutely, the registered person supplying such goods or services or both shall not collect the tax, more than the effective rate, on such supply of goods or services or both

8.1 Introduction

This provision of this section states that the Central Government may grant exemptions for

intra-State supply of goods and / or services within a Union Territory. Reference may also be made to Section 11 of the CGST Act and Section 6 of the IGST Act for a detailed analysis.

8.2 Analysis

The Central Government will be empowered to grant exemptions from payment of UTGST on intra-State supplies within Union Territory, subject to the following conditions:

- (i) Exemption should be in public interest
- (ii) By way of issue of notification
- (iii) On recommendation from the Council
- (iv) Absolute / conditional exemption may be for any goods and / or services
- (v) Exemption by way of special order (and not notification) may be granted by citing the circumstances which are of exceptional nature.
 - With specific reference to the fourth condition indicated above, it is important to note that the exemption would only be in respect of goods and / or services, and not specifically for classes of persons.
 - It is to be noted that in cases where goods and/or services are exempt absolutely, no input tax credit can be claimed.
 - Mandatory nature of absolute exemptions has been litigated in the past and where tax is paid even though exemption is available, credit becomes admissible. For this reason, even inadvertence in not availing such absolute exemptions are made inexcusable. As such, credit denial also becomes absolute. No plea of equity or revenue neutrality becomes admissible.
 - There is generally not much doubt about exemptions – whether absolute or conditional – because the condition associated may be examined at one-time or continuously to be satisfied. Conditional exemptions abate if the associated condition is not complied. Care should be taken not to mistake conditional exemption with absolute exemption having specific applicability.
 - Although there is a view that in case of conditional exemptions, it could operate as an optional exemption such that the taxable person may pay higher rate of tax (so that there would be no requirement for input tax credit reversals). However, an absolute exemption is required to be followed mandatorily. The other view is that exemptions would not be optional and would be mandatory and the associated conditions are also mandatorily to be satisfied.
 - In terms of sub-Section (2), the Government may issue a special order on a case-to-case basis. The circumstances of exceptional nature would also have to be specified in the special order. While this provision is welcome, trade and industry is apprehensive that this could be used without necessary superintendence.

- To provide more clarity to the exemption notification or the special order, it is provided that the Government may issue an “Explanation” at any time within a period of 1 year from the date of notification or special order. The effect of this “Explanation” would be retrospective, viz., from the effective date of the relevant notification or special order.
- The law makes it clear that when the exemption is absolute (i.e., if whole or part of tax leviable is exempt) the registered person cannot collect taxes more than the effective rate.

Exemption under section 11 of the CGST/SGST Act equally applicable

Any exemption notification or special order issued under Section 11 of the CGST Law will apply equally for intra-UT supplies, viz., any supply of goods or services or both which are exempt under CGST Law will be exempt even under the UTGST Law.

Effective date of the notification or special order

The effective date of the notification or the special order would be date which is so mentioned in the notification or special order. However, if no date is mentioned therein, it would come into force on the date of its issue by the Central Government for publication in the Official Gazette. It follows that such notification/ order shall be made available on the official website of the department of the Central Government.

8.3 Comparative review

The provisions relating to exemption are broadly like the exemption provisions under the erstwhile tax regime. There are no significant differences.

8.4 Related provisions

Statute	Section	Description
CGST	Section 11	Exemption from payment of CGST / SGST
IGST	Section 6	Exemption from payment of IGST
UTGST	Section 8	Power to grant exemption from tax

Chapters of UTGST Act covered under CGST / IGST

Sl. No.	Chapter No. / Heading – UTGST	Sections No. – UTGST	Description
1	IV – Payment of tax	9	Payment of tax
		10	Transfer of input tax credit
2	V – Inspection, Search, Seizure and Arrest	11	Officers required to assist proper officers

3	VI – Demands and Recovery	12	Tax wrongfully collected and paid to the Central Government or UT Government
		13	Recovery of tax
4	VII – Advance Ruling	14	Definitions
		15	Constitution of Authority for Advance Ruling
		16	Constitution of Appellate Authority for Advance Ruling
5	VIII – Transitional Provisions	17	Migration of existing tax payers
		18	Transitional arrangements for input tax credit
		19	Transitional provisions relating to job work
		20	Miscellaneous transition provisions
6	IX- Miscellaneous	21	Application of provisions of CGST Act
		22	Power to make Rules
		23	General power to make regulations
		24	Laying of rules, regulations and notifications
		25	Power to issue instructions or directions
		26	Removal of difficulties

- The sections cited supra other than the provisions relating to Chapter IX - Miscellaneous are discussed in the relevant sections of CGST / IGST laws wherever deemed fit.
- The Chapter IX - Miscellaneous other than Section 21 of the UTGST Act are similar to the provisions as discussed in the context of IGST Act. There is an additional provision (section 25 under the UTGST Act), which deals with Commissioner's power to issue instructions or directions, which is similar to section 168 of the CGST Act. Readers are requested to refer to the said provisions in this context.

The discussion on the following provisions have been provided in the CGST Act in the relevant chapters/sections.

(i)	scope of supply;
(ii)	composition levy;
(iii)	composite supply and mixed supply;
(iv)	time and value of supply;
(v)	input tax credit;
(vi)	registration;
(vii)	tax invoice, credit and debit notes;
(viii)	accounts and records;
(ix)	returns;
(x)	payment of tax;
(xi)	tax deduction at source;
(xii)	collection of tax at source;
(xiii)	assessment;
(xiv)	refunds;
(xv)	audit;
(xvi)	inspection, search, seizure and arrest;
(xvii)	demands and recovery;
(xviii)	liability to pay in certain cases;
(xix)	advance ruling;
(xx)	appeals and revision;
(xxi)	presumption as to documents;
(xxii)	offences and penalties;
(xxiii)	job work;
(xxiv)	electronic commerce;
(xxv)	settlement of funds;
(xxvi)	transitional provisions; and
(xxvii)	miscellaneous provisions including the provisions relating to the imposition of interest and penalty,

It is important to note that the UTGST Act is legislated by the Central Government and the corresponding rules would also be legislated under its authority.

Note: All Relevant UTGST notifications are provided in forthcoming pages of this publication.

Following rules are common to all UT GST acts i.e., Lakshadweep, Andaman & Nicobar, Dadra & Nagar Haveli, Daman & Diu and Chandigarh.

Rule 1: Short title and Commencement.

- (1) These rules may be called the Union Territory Goods and Services Tax (Andaman and Nicobar Islands) Rules, 2017.
- (2) They shall come into force with effect from the 1st day of July, 2017.

Rule 2: Adaptation of Central Goods and Services Tax Rules, 2017.

(1) The Central Goods and Services Tax Rules, 2017, in respect of scope of supply, composition levy, composite supply and mixed supply, time and value of supply, input tax credit, registration, tax invoice, credit and debit notes, accounts and records, returns, payment of tax, tax deduction at source, collection of tax at source, assessment, refunds, audit, inspection, search, seizure and arrest, demands and recovery, liability to pay in certain cases, advance ruling, appeals and revision, presumption as to documents, offences and penalties, job work, electronic commerce, settlement of funds, transitional provisions, and miscellaneous provisions including the provisions relating to the imposition of interest and penalty, shall, mutatis mutandis, apply except the following rules:-

Rules	Particulars
Rule 90 (4) of CGST Rules 2017	Acknowledgement
Rule 117 (1) – for Second proviso of CGST Rules 2017	Tax or duty credit carried forward under any existing law or on goods held in stock on the appointed.
Rule 119 of CGST Rules 2017	Declaration of stock held by a principal and job-worker

(a) **Analysis of the Amendment to the Rules: For Amendment of Rule 90(4) of the CGST Rules 2017**

In terms of Rule 90 (4) of the CGST Rules 2017 read as

*“(4) Where deficiencies have been communicated in FORM GST RFD-03 under the **State Goods and Service Tax Rules, 2017**, the same shall also deemed to have been communicated under this rule along with the deficiencies communicated under sub-rule (3)”.*

In terms of the amendment to the Rule to UTGST Rules, 2017 shall be read as

*“(4) Where deficiencies have been communicated in FORM GST RFD-03 under the **Central Goods and Service Tax Rules, 2017**, the same shall also deemed to have been communicated under this rule along with the deficiencies communicated under sub-rule (3).”;*

The aforesaid rules have been amended to the extent of for the words **State Goods and Service Tax Rules, 2017** shall be read as **Central Goods and Service Tax Rules, 2017** in line with the CGST Rules.

(b) **For Amendment to the Rule 117 of CGST Rules 2017**

- (i) The Second proviso of the CGST Rules, 2017 provides obligation to file a details of an Transitional claim in respect of Forms received and pending with regards to Form C , Form I, Form H, Form F as specified in Rule 12 of the Central Sales Tax (Registration and Turnover) Rules, 1957.
- (ii) Further, in terms of the Rule 117(4) of CGST Rules 2017 a registered person who was not registered under the existing law shall eligible to availment of Credit. However, this provision is not made applicable under the provisions of UTGST Rules.

(c) **For Amendment to the Rule 119 of CGST Rules 2017 for the purpose of application of UTGST Rules 2017**

Rule 119 of UTGST Rules 2017 provides declaration of stock held by principal and agent shall be within 90 days of the appointed day (w.e.f.01.07.2017) electronically in Form GST TRAN-1. Section 142(14) is not traceable to the CGST Act, 2017, as a corollary one may have to fall back on the SGST Legislation.

Other rules of UGST shall be same as of Central Goods of Services Tax Rule, 2017

Explanation:- For the purposes of these rules, it is hereby clarified that all references to section 140 of the Central Goods and Services Tax Act, 2017, shall be construed to refer to section 18 of the Union Territory Goods and Services Tax Act, 2017.

GOODS AND SERVICE TAX (COMPENSATION TO STATES) ACT, 2017

The Goods and Service Tax (Compensation to States) Act, 2017 provides for a mechanism to compensate the States on account of loss of revenue which may arise due to implementation of the Goods and Services Tax read together with the Constitutional (one Hundred and First Amendment) Act, 2016, for a period of 5 years.

This Act, inter-alia provides:

- (a) That the base year during the transition period shall be reckoned as the financial year 2015-16 for the purpose of calculating compensation amount payable to the States;
- (b) That the revenue proposed to be compensated would consist of revenues from all taxes that stands subsumed into the GST law, as audited by the CAG;
- (c) For reckoning the growth rate of revenue subsumed for a State at 14% per annum;
- (d) That the compensation will be released bi-monthly based on the provisional numbers furnished by the Central Accounting Authorities and the final adjustment to be done after the accounts are subjected to audit by CAG;
- (e) That the revenue foregone on account of grant of exemption in the 11 special categories State (Article 279A), be counted for the purpose of determining revenue for the base year 2015-16;
- (f) That the revenue of States directly devolved to Mandi / Municipalities would be considered as revenue subsumed;
- (g) Levy of a cess over and above the GST on certain notified goods to compensate States for 5 years on account of revenue loss suffered by them;
- (h) That the proceeds of the cess will be utilised to compensate States that warrant payment of compensation;
- (i) That 50% of the amount remaining unutilised in the fund at the end of the fifth year will be transferred to the Centre and the balance 50% would be distributed amongst the State and Union Territories in the ratio of total revenues from SGST / UTGST of the fifth year;

Relevant Sections of the GST Compensation Act warranting attention are reproduced below:

2. Definitions:

- (c) *“cess” means the goods and service tax compensation cess levied under section 8;*
- (g) *“input tax” in relation to a taxable person, means:*
 - (i) *the cess charged on any supply of goods or services or both to him;*

(ii) *the cess charged on import of goods, and includes the cess payable on reverse charge basis;*

(p) *“taxable supply” means a supply of goods or services or both which is chargeable to the cess under this Act;*

8. Levy and Collection of Cess

(1) *There shall be levied a cess on such intra-State supplies of goods or services or both as provided for in Section 9 of CGST Act and such inter-State supplies of goods or services or both as provided for in Section 5 of IGST Act, 2017 and collected in such manner as may be prescribed on the recommendations of the Council, for the purposes of providing compensation to the States for loss of revenue arising on account of implementation of the goods and services tax with effect from the date from which the Central Goods and Service Tax Act is brought into force for a period of five years or for such period as may be prescribed on the recommendations of the council.*

Provided that no such cess shall be leviable on supplies made by a taxable person who has decided to opt for composition levy under section 10 of the Central Goods and Service Tax Act.

(2) *The cess shall be levied on such supplies of goods and services as are specified in column 2 of the Schedule, on the basis of value, quantity or on such basis at such rate not exceeding the rate set-forth in the corresponding entry in column 4 of the Schedule, as the Central Government may, on the recommendations of the Council, by notification in the Official Gazetted, specify.*

Provided that where the cess is chargeable on any supply of goods or services or both with reference to their value, for each such supply the value shall be determined under Section 15 of the Central Goods and Service Tax Act for intra-State and inter-State supplies of goods or services or both.

Provided further that the cess on goods imported into India shall be levied and collected in accordance with the provisions of Section 3 of the Customs Tariff Act, 1975(51 of 1975), at the point when duties of customs are levied on the said goods under Section 12 of the Customs Act, 1962 (52 of 1962), on a value determined under the Customs Tariff Act, 1975.

9. Returns, Payments and Refunds

(1) *Every taxable person registered making a taxable supply of goods or services or both, shall –*

(a) *Pay the amount of cess as payable under this Act in such manner;*

(b) *Furnish such returns in such forms, along with the returns to be filed under the Central Goods and Services Tax Act; and*

(c) *Apply for refunds of such cess paid in such form, as may be prescribed.*

(2) For all purposes of furnishing of returns and claiming refunds, except for the form to be filed, the provisions of the Central Goods and Service Tax Act and the rules made thereafter, shall, as far as may be, apply in relation to the levy and collection of the cess leviable under section 8 on all taxable supplies of goods or services or both, as they apply in relation to the levy and collection of Central Tax on such supplies under the said Act or the rules made thereunder.

10. Crediting proceeds of Cess to Fund

(1) The proceeds of the cess leviable under section 8 and such other amounts as may be recommended by the Council, shall be credited to a non-lapsable Fund known as the Goods and Services Tax Compensation Fund, which shall form part of the public account of India and shall be utilised for purposes specified in the said section.

(2) All amounts payable to the States under section 7 shall be paid out of the Fund.

(3) Fifty per cent. of the amount remaining unutilised in the Fund at the end of the transition period shall be transferred to the Consolidated Fund of India as the share of Centre, and the balance fifty per cent. shall be distributed amongst the States in the ratio of their total revenues from the State tax or the Union territory goods and services tax, as the case may be, in the last year of the transition period.

(3A) Notwithstanding anything contained in sub-section (3), fifty per cent. Of such amount, as may be recommended by the Council, which remains unutilised in the Fund, at any point of time in any financial year during the transition period shall be transferred to the Consolidated Fund of India as the share of Centre, and the balance fifty per cent. shall be distributed amongst the States in the ratio of their base year revenue determined in accordance with the provisions of section 5:

Provided that in case of shortfall in the amount collected in the Fund against the requirement of compensation to be released under section 7 for any two months' period, fifty per cent. of the same, but not exceeding the total amount transferred to the Centre and the States as recommended by the Council, shall be recovered from the Centre and the balance fifty per cent. from the States in the ratio of their base year revenue determined in accordance with the provisions of section 5."¹

(4) The accounts relating to Fund shall be audited by the Comptroller and Auditor General of India or any person appointed by him at such intervals as may be specified by him and any expenditure in connection with such audit shall be payable by the Central Government to the Comptroller and Auditor-General of India.

(5) The accounts of the Fund, as certified by the Comptroller and Auditor-General of India or any other person appointed by him in this behalf together with the audit report thereon shall be laid before each House of Parliament

¹ Inserted vide The Goods And Services Tax (Compensation To States) Amendment Bill, 2018 w.e.f. 01.02.2019

11. Other Provisions Relating to Cess

(1) The provisions of the Central Goods and Services Tax Act and the rules made thereunder, including those relating to assessment, input tax credit, non-levy, short-levy, interest, appeals, offences and penalties, shall, as far as may be, mutatis mutandis apply in relation to the levy and collection of the cess leviable under Section 8 on the intrastate supply of goods and services, as they apply in relation to the levy and collection of Central Tax on such intra-state supplies under the said Act or the rules made thereunder.

(2) The provisions of the Integrated Goods and Services Tax Act, and the rules made thereunder, including those relating to assessment, input tax credit, non-levy, short-levy, interest, appeals, offences and penalties, shall mutatis mutandis apply in relation to the levy and collection of the cess leviable under Section 8 on the inter-state supply of goods and services, as they apply in relation to the levy and collection of Integrated Goods Tax on such inter-state supplies under the said Act or the rules made thereunder.

Provided that the input tax credit in respect of Cess on supply of goods and services leviable under Section 8, shall be utilised only towards payment of said Cess on supply of goods and services leviable under the said Section.

Note: The CGST Rules, 2017 would apply mutatis mutandis to the GST Compensation Act, 2017 other than the rules relating to Composition (Rule 3 to 7) and Transitional Provisions (Rule 117 to 121)

Relevant circulars, notifications, clarifications, flyers issued by Government: -

1. Notification No. 1/2017 dated 28.06.2017 - GST Cess Rate notifying the rates of cess on goods (as amended from time to time)
2. Notification No. 2/2017 dated 28.06.2017 - GST Cess Rate notifying the rates of cess on services (as amended from time to time)
3. Notification No. 4/2017 dated 20.07.2017 - GST Cess Rate regarding exemption to intra-State supplies of second hand goods received by a registered person, dealing in buying and selling of second hand goods
4. Notification No. 7/2017 dated 13.10.2017 - GST Cess Rate regarding reduced rate of cess on the leasing of motor vehicles (purchased and supplied on lease before 01.07.2017)
5. Notification No. 1/2018 dated 25.01.2018 – GST Cess Rate regarding exemption from cess on all old and used motor vehicles on which supplier has not availed any credits
6. Circular No. 1/1/2017-Compensation Cess dated 26.07.2017 regarding applicability of Section 16 of the IGST Act, 2017 (zero rated supply) for the purpose of Compensation Cess on exports

Salient features of the GST Compensation Act:

I. Levy of cess:

- GST Compensation Cess (under Section 8 of the Act) will be levied on all intra-State and inter-State supplies of goods or services or both, including import of goods.
- The following supplies will be liable at the rate specified below:
 - Pan Masala (60% *ad valorem*)
 - Tobacco and Tobacco products (Rs. 4,170 per 1,000 sticks or 290% *ad valorem* or a combination thereof)
 - Coal, briquettes and similar solid fuels (Rs. 400 per tonne)
 - Aerated Water (12% *ad valorem*)
 - Used and old Motor vehicles, Ambulance, Cars for physically handicapped persons, Electrically operated vehicles, Three wheeled vehicles, Motor vehicles of engine capacity not exceeding 1500cc and of length not exceeding 4000 mm (NIL)
 - Motor cars and passenger motor vehicles (15% *ad valorem*), SUVs (22% *ad valorem*)
- The Cess would not be leviable on supplies made by a person who has opted for composition levy.
- Those supplies that are liable to tax with reference to their value (i.e. all supplies except coal, briquettes and similar solid fuels), are to be determined based on the Valuation provisions under Section 15 of the CGST Act.
- The cess levied under this Act would be payable over and above the CGST, SGST/UTGST and IGST tax leviable on. Cess would be levied on whole value exclusive of GST i.e. for Transaction value as per Section 15 is Rs. 100 and GST Rate is 18% then Cess would be levied on Rs. 100 Calculation would be Rs. 100+18% GST+ % Compensation Cess (as specified).
- **Dealer of second-hand goods:** The levy of Cess has been exempted on intra-State procurement of second hand goods from an un-registered supplier when purchased by a registered person dealing in buying and selling of second hand goods and who pays the Cess on the margin basis of computation envisaged under rule 32(5) of the CGST Rules.
- The Central Government reduced the rate of Cess at 65% of the Cess which is otherwise payable on supply of motor vehicles which are purchased or leased before July 1, 2017 subject to the condition that such supplier has not availed input tax credit of Central Excise Duty or VAT or any other taxes paid thereon w.e.f. 13.10.2017.
- As a further relief measure, the Central Government has prescribed 'NIL' rate of Cess on supply of all old and used motor vehicles on which supplier has not availed CENVAT

Goods and Services Tax (Compensation to States) Act, 2017

or VAT credit under the earlier regime or input tax credit in GST regime w.e.f. 25.01.2018.

- The scope and applicability of the notifications issued in respect of old and used motor vehicles (MV), can be better understood by a comparative analysis as summarised below:

Particulars	Notification No. 7/2017– Compensation Cess (Rate) dated 13th October, 2017	Notification No. 1/2018 Compensation Cess (Rate) dated 25th January, 2018
Scope	a. MV purchased and leased prior to July 1, 2017 which are continued to be leased in GST regime b. MV purchased prior to July 1, 2017 and supplied in GST regime	All old and used MVs Note: 1. Not applicable on lease transactions. 2. Can be purchased either before or after July 1, 2017
Rate of Cess	65% of Cess payable	NIL
Condition	Input tax credit (ITC) of Central Excise duty, VAT or any other taxes paid is not taken	ITC not taken in GST regime or CENVAT credit or VAT credit not availed in earlier regime

Refund of Cess upon Export:

- Exporter will be eligible to claim refund of Cess paid under the Act on export of goods on the similar lines as refund of IGST paid on exports. Further, Cess will not be charged on goods exported by an exporter under bond / LUT and refund of input tax credit of Cess relating to goods exported will be available on similar lines as refund of input taxes in relation to zero-rated supplies.

II. Determination of Base Year Revenue:

- The Compensation amount to be paid in any year during the transition period is to be computed taking the base year as 2015-16 only.
- The provisions of Section 5(1) of the said Act lists the taxes imposed by State / Union that stand subsumed into the GST while the proviso to Section 5(1) lists out the taxes that shall not be included for calculation of base year revenue. The revenue collected by the States on account of the said taxes detailed in Section 5(1) of the Act alone would be considered for the determination of Base Year Revenue;
- The revenue collected would always be reckoned as 'net of refunds';
- The transition period will be the period of 5 years from the date when the respective SGST Acts commence.

III. Input Tax Credit and returns:

- Input Tax Credit on inward supplies liable to cess can be utilized only for payment of cess on outward supplies liable to cess under the Act.
- A taxable person effecting supplies chargeable to cess is required to file returns along with the returns prescribed under the CGST Act.

IV. General

- All provisions of CGST Act and IGST Act including input tax credit, assessment, offences, penalties, interest, non-levy and short-levy will apply in relation to the levy and collection of cess on intra-State and inter-State supply, respectively.

Note: The relevant notifications on Compensation Cess have been provided in forthcoming pages of this publication

NOTE ON STATE GST LAWS & RULES

In the scheme of overall implementation of GST, the Parliament enacts Central GST Act, Integrated GST Act, Union Territory GST Act (which is a single law enacted by the Parliament in respect of all the 5 Union Territories without legislature) and when it comes to State GST Acts, each of the State legislatures are to enact their respective State GST enactments and frame Rules thereunder.

As discussed in this background material in detail, on intra-state supply of goods or services, two levies would stand attracted, i.e. Central GST and State GST in case of States and Union Territories with legislature (Delhi and Puducherry) ; Central GST and Union Territory GST in case of Union Territories (5 Union Territories). When the same transaction attracts two taxes, both the enactments should operate simultaneously in the absence of which compliance with law arises. In that direction, the GST Council had provided to all the States, a version of State GST law for enactment in the respective States. It is needless to say that all the States have more or less followed the CGST Act to enact their State level GST laws. In respect of certain goods which still attract Value Added Taxes / Central Sales tax in respect of a transaction of sale, some States have still retained certain powers through the “repeal and savings provision” in the State Level GST enactments.

The GST shall have two components: one levied by the Centre (referred to as Central GST or CGST), and the other levied by the States (referred to as State GST or SGST). Rates for Central GST and State GST would be approved appropriately, reflecting revenue considerations and acceptability.

The CGST and the SGST would be applicable to all transactions for intra state supply of goods and services made for a consideration except the exempted goods and services.

Cross utilization of ITC both in case of Inputs and capital goods between the CGST and the SGST would not be permitted except in the case of inter-State supply of goods and services (i.e. IGST).

The Centre and the States would have concurrent jurisdiction for the entire value chain and for all taxpayers on the basis of thresholds for goods and services prescribed for the States and the Centre.

All the States have passed the State GST Acts including J&K whether through an ordinance or through the respective legislatures. On a perusal of the same it can be seen that almost all the provisions are identical with the provisions of Central GST Act with suitable modifications as to State GST.

In this background material:

The rules are considered and discussed at appropriate places / sections / chapters. These rules are issued under the delegated legislation by the Central Government in so far as the CGST, IGST and UTGST laws are concerned whereas it is issued by the respective State Government when it comes to SGST law.

Note on State GST Laws & Rules

Special Category States under GST include:

1. Jammu and Kashmir
2. Manipur
3. Mizoram
4. Nagaland
5. Tripura

With the effect of Finance Act 2018 from 1st February 2018, the states of Arunachal Pradesh, Assam, Himachal Pradesh, Meghalaya, Sikkim and Uttarakhand shall no more be included in the expression "special category state".

Aggregate Turnover Limit for Registration as per CGST Act:

Section 22 of the CGST Act provides that every supplier shall be liable to be registered under this Act, in the State or Union territory, other than special category States, from where he makes a taxable supply of goods or services or both, if his aggregate turnover (refer 2(6) of the CGST Act) in a financial year exceeds twenty lakh rupees:

Provided that where such person makes taxable supplies of goods or services or both from any of the special category States, he shall be liable to be registered if his aggregate turnover in a financial year exceeds ten lakh rupees.

SGST Law for special category States without the said proviso:

Every supplier making a taxable supply of goods or services or both in the State, shall be liable to be registered under this Act if his aggregate turnover in a financial year exceeds ten lakh rupees.

It is important to note that in respect of the notifications issued under the CGST Act the presumption is that it would equally apply to the State / Union Territory GST law, as well. At this juncture, it is noticed that several States have not issued the corresponding notifications under the respective State Level GST laws. This, in the normal course must not affect the taxability or otherwise, of such transactions. It would be a good practice that States follow this requirement scrupulously to avoid any misunderstanding.

One can proceed based on assumption that in the normal course the State GST Laws would be *pari materia* with the CGST Laws / Rules framed thereunder.